



CELO

**Fixings
Technology**

Catálogo
2022

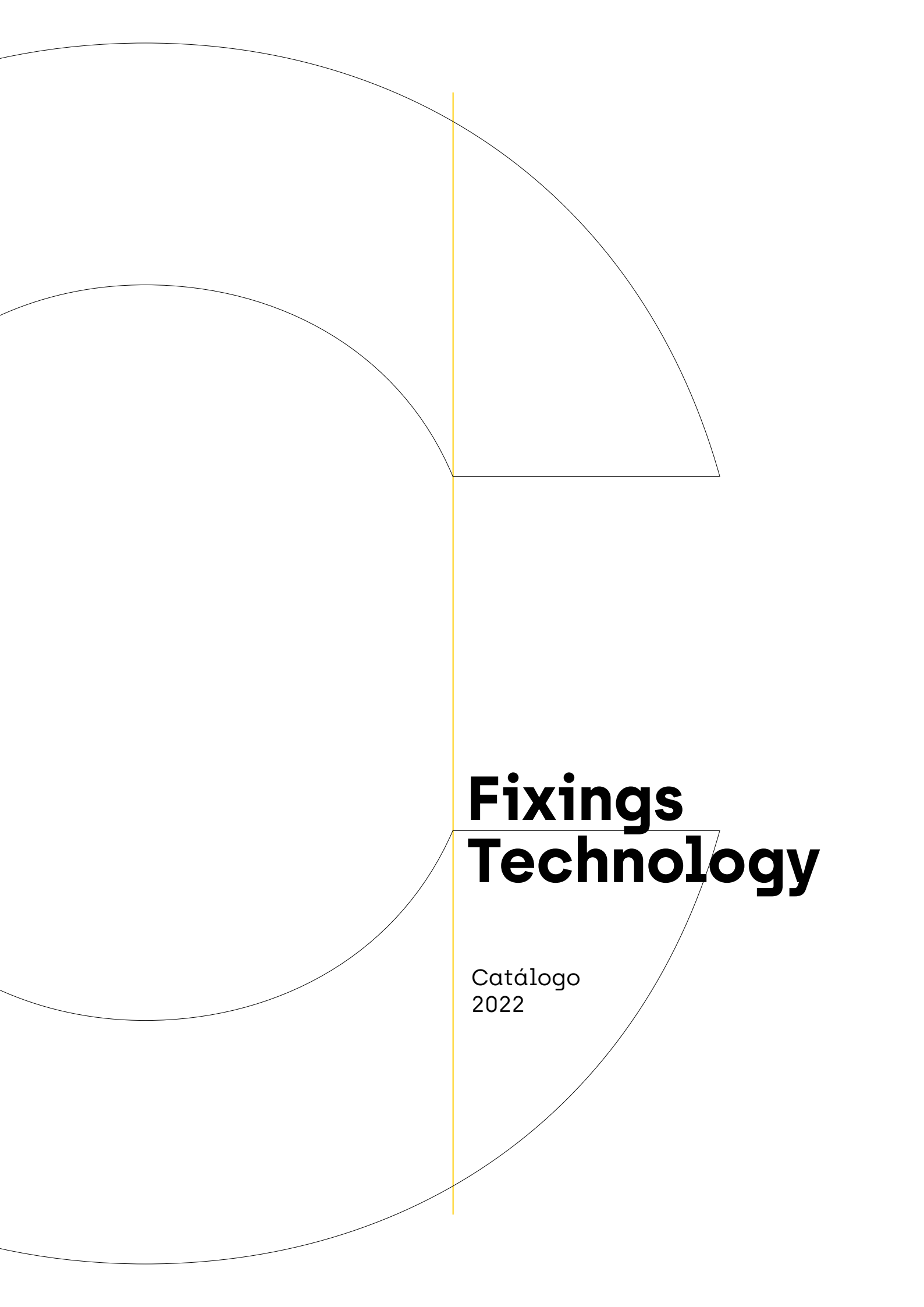

The background features a vertical orange line that divides the page. On the left side, there are two large, thin, curved lines that sweep from the top and bottom towards the center, creating a sense of movement and depth. The text is positioned on the right side of the vertical line.

Fixings Technology

Catálogo
2022





Novedades

Nuevos Productos 2022













Nos apasiona nuestro trabajo independientemente del puesto o área de especialización y buscamos la excelencia en todo lo que hacemos.

Nuestro objetivo es contribuir al desarrollo de nuestro sector innovando y aportando valor a nuestro trabajo.

Fijación

	Taco multimaterial MFR 10x60 con doble empotramiento 50/70. p. 44
	Taco para cartón yeso GKDZ más largo. p. 60
	ResiFIX® VY ECO. p. 97

Sujeción

		Nueva gama SMART clamps. p. 120
	Perfil 35x18. p. 197	
	Abrazadera multicable CHS. p. 221	
	Base con brida incorporada TBT. p. 216	
	Clavadora a gas FOX p. 224	
	Brida de nylon CCT en gris. p. 138	
	Arandela nylon AP16. p. 216	
	Arandela nylon AP30. p. 227	
	Clavos de acero TKA nuevas medidas. p. 225	
	Clavos de acero XHA homologados CE. p. 211	
	Más gama de grapas PFT y DFT. p. 222	

Tornillería

	Tornillos para PVC: PVS, PVM y PVP. p. 272 p.273
---	---

Servicios

Estructuras solares
p. 208

Taco de nylon multimaterial MFR

Permite el montaje universal de estructuras en fachadas, piezas de madera y metal y también en todos los materiales base comunes.



Taco de nylon F

El clásico con gran expansión para cargas medias. Tiene una gran capacidad de resistencia.



Punta broca cabeza métrica Torab

Para perfiles y vigas de hasta 6 mm de grosor. La cabeza métrica sirve para fijar abrazaderas y accesorios. Homologado al fuego.



Fabricante de perfiles

Amplia gama de perfiles metálicos y sistemas de soporte para instalaciones.



Tornillo de construcción BMax

Tornillo de construcción homologado con cabeza avellanada o alomada con arandela estampada.



Tornillos VELOX®

Con una verdadera pasión por los detalles. Tornillos para madera y construcción con homologación ETA e impronta SIT.



Abrazadera rápida RIF

Ofrecemos una extensa gama de abrazaderas aislantes con goma EPDM para soportar altas temperaturas y con nervios de refuerzo.



Anclaje de techo suspendido DA

Profundidad de anclaje reducida. Con aprobación ETA y alto confort de instalación.



Anclaje espárrago BAP

Para multitud de aplicaciones. Gracias a la marca de empotramiento amarilla facilita el montaje. Grandes cargas homologadas para tu seguridad.



ResiFIX VYSF

Homologación ETA Opción 1 para hormigón fisurado. Aprobación ETA para varilla coarrugada y ETA para mampostería.



Abrazadera Abranyl® ABM multidiámetro Nylon

La abrazadera se cierra presionando el tubo hacia ella. Se puede instalar con taco y tornillo.



Small Thin

Tornillo de hormigón BTS

Cargas altas, fácil instalación. Rango extendido con aprobación ETA para hormigón fisurado.



Tornillo para hormigón BTS6

Fijación rápida y directa para hormigón, apta para una amplia gama de instalaciones. Aprobación ETA para usos múltiples, para aplicaciones no estructurales en hormigón fisurado y no fisurado.



Fijaciones sanitarias

Simple y rápidas. Productos que ahorran tiempo y facilitan la instalación.



Tornillo de aislamiento IPS

Nueva solución para la fijación de perfiles metálicos en SATE, ¡muy rápida y fácil! Fijación directa al material aislante. Sin puente térmico y disponible en diferentes colores.



Taco de aislamiento IPL 95DS

¡Simple, rápido, flexible y ajustable! Solución innovadora para la fijación de bajantes en SATE. Fijación directa en materiales de aislamiento, sin puente térmico.



ResiTHERM®

Sistema innovador para montajes de altas cargas en SATE. Solución perfecta para ladrillos huecos con aislante exterior. Sin puente térmico.



FORCE ONE: La clavadora de gas definitiva

Una herramienta ligera, potente y ergonómica.



Basculante multiuso BT

La fijación rápida y fuerte de cavidad universal. Fácil de instalar.



Taco brida rápido InsertFIX

Simplemente taladre con una broca de 6 mm para hacer un pequeño agujero y presione el taco, sin herramientas, solo con la mano.

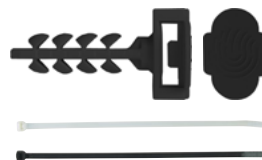

ings Matter

Fijación sanitaria

Anclaje directo a hormigón

Fijación para hueco

Fijación para aislamiento

Fijaciones eléctricas

Clavadora a gas y accesorios

En CELO, sabemos que nuestros tornillos y fijaciones representan una parte muy pequeña del coste total del ensamblaje. Nos preocupamos para que nuestros productos sean competitivos, pero sobre todo nos preocupamos por desarrollar e innovar en productos y servicios que reduzcan tus costes de ensamblaje, desde el diseño hasta la instalación.

Trabajamos para que nuestros tornillos y fijaciones tengan un coste competitivo, pero también nos preocupamos por reducir los costes totales de instalación, logística e incluso de las líneas de producción.

Nuestros ingenieros técnicos de ventas y aplicación están listos para ayudarles.

- **Tu tiempo. Nuestro valor**
- **Innovación**
- **Know-How**
- **Calidad**





Compañía

En CELO, cuidamos los pequeños detalles:

Small Things Matter

Mira a tu alrededor. Mira todas las cosas que hacen que nuestro mundo funcione, desde las más grandes, hasta las más pequeñas, desde las más simples, hasta las más sofisticadas. Todo, absolutamente todo, está compuesto de pequeñas piezas que unidas, forman parte de algo más grande que no puede fallar.

Nosotros conocemos bien su importancia, y por eso, como especialistas, cuidamos cada pieza desde su creación hasta su instalación aplicando la última tecnología e innovando para hacerlo mejor cada día.

OTTE

Calidad, know-how e innovación forman el ADN de nuestra empresa.

CELO quiere ser un líder internacional en tornillos técnicos e innovadores y fijación técnica que reduzcan el tiempo y el coste de instalación y montaje.

$$CELO \#1 = \left(\frac{\text{💡} \times \text{🌐}}{\text{🕒} + \text{💰}} \right) \text{👏}$$

Representamos nuestro ADN con una simple ecuación:

- El conocimiento, la innovación y el alcance internacional hacen crecer nuestra empresa.
- El ahorro de tiempo y la reducción de costes para nuestros clientes y para CELO hacen que nuestra empresa crezca.
- Nuestro equipo es la parte de la ecuación que potencia más nuestro desarrollo.



**Calidad
"Made in Germany"**

Departamento de desarrollo interno





**Orientación
al cliente**



**Soluciones para
cada necesidad**

Tus beneficios

- Aportamos **soluciones innovadoras** que ahorran tiempo de instalación y facilidad de montaje.
- **Amplia gama de productos** y servicios para instaladores profesionales.
- **Cooperación** basada en la proximidad y en prescripción de productos.
- **Experiencia** en el diseño, desarrollo y fabricación de sistemas de tornillería, fijación y sujeción.
- **La más alta calidad** de producto garantizada por homologaciones y certificaciones.
- **Presencia mundial** con fábricas propias.

Servicio al cliente

T. +34 937 158 383

info@celofixings.es

HORARIO:

LUNES - VIERNES: 7:30 A.M. - 21:30 P.M.

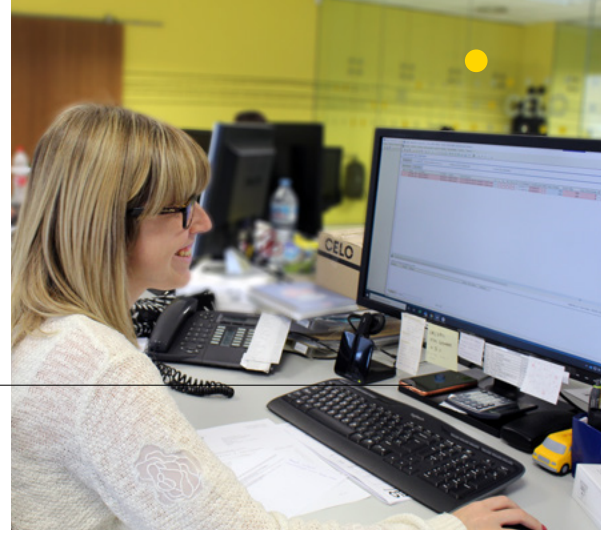

Servicio de campo

- › Comprometido - Competente – Flexible
- › Amplio servicio de atención.
- › Consulta personal.
- › Recomendaciones de productos.
- › Planificación y servicio de lineales.
- › Roadshow.



Democar

- › Servicio para nuestros distribuidores.
- › Formación interna de conocimientos técnicos.
- › Formación teórica y práctica del producto.
- › Pruebas de extracción y soporte técnico.
- › Formación y asesoramiento de usuarios finales *
- › Visita a la obra*

*A consultar con su distribuidor especializado.



Centro de formación

- › Formación del conocimiento técnico de tornillería, fijación y sujeción.
- › Formación teórica y práctica del producto.
- › Intercambio de experiencias.
- › Pequeños grupos de seminario [máx. 15 personas].
- › Certificado de participación realizada con éxito.



Software de diseño - Anclajes + Tornillos

SOFTWARE DE DISEÑO – ANCLAJES

- › Diseño de anclajes de alta resistencia - anclajes metálicos y químicos - en hormigón.
- › Cálculo rápido en tiempo real.
- › Interfaz de usuario intuitiva, que incluye gráficos tridimensionales.
- › Posicionamiento de anclaje flexible para varias geometrías de placa base.
- › Perfecto para planificadores y arquitectos.
- › Documentación profesional y clara.
- › Disponible en varios idiomas.
- › Excelentes características.
- › Visualización de tensión de la placa base (cálculo FEM).

SOFTWARE DE DISEÑO – TORNILLOS

- › Cálculo de cargas en viga y conexiones universales [madera-madera / acero-madera].
- › Cargas predefinidas de viento y nieve en el módulo de aislamiento de la viga por código postal.
- › Soporte durante el diseño de cada aplicación.
- › Cálculo en tiempo real con determinación automática del resultado más económico.
- › Diseño de tornillos BMax y VELOX® SIT según ETA, EN 1995-1-1 y DIN EN 1995-1-1 / NA.

descarga gratuita en www.celofixings.es

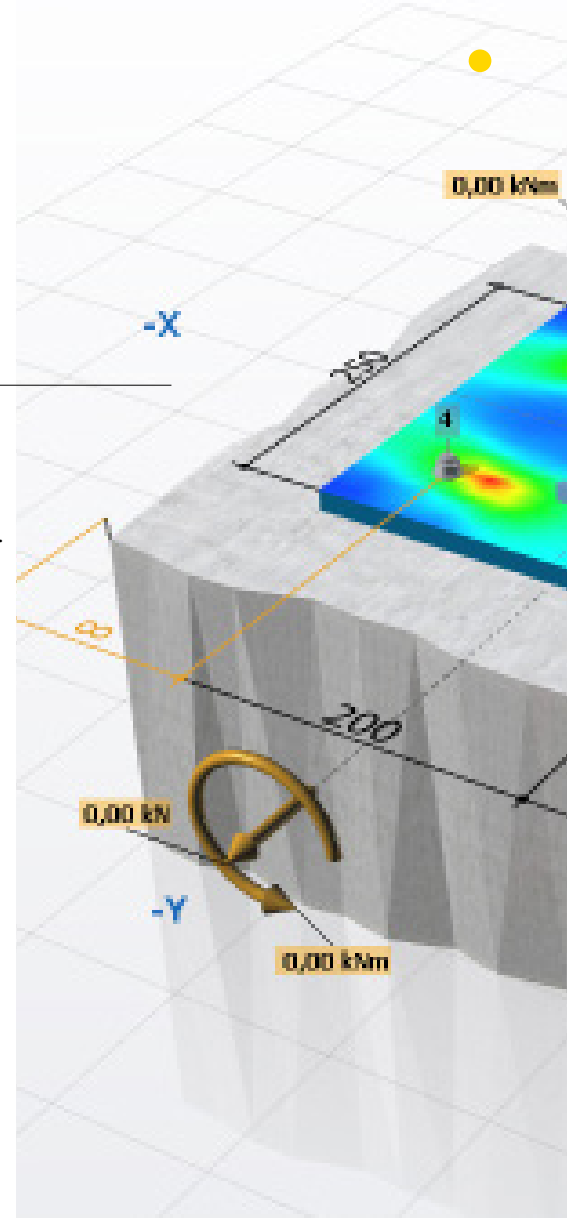

Tecnología de aplicación

- › Cálculo de diseño para anclajes.
- › Pruebas de extracción en obras de construcción.
- › Asesoramiento técnico telefónico.
- › Consejos y recomendaciones para todo tipo de anclajes.

celofixings.es

- › Información actualizada del producto con un buscador predecible.
- › Aprobaciones, DoPs, hojas de datos de seguridad.
- › Vídeos de instalación.
- › Catálogos y folletos.
- › Noticias y eventos.
- › Información sobre la instalación de anclajes.
- › Enlace de descarga para el software de diseño.



Información importante sobre el catálogo 2022

Este catálogo es un documento de información comercial.

Los datos, información técnica, imágenes y precios son orientativos.

CELO se reserva el derecho a modificar sin previo aviso el diseño de productos.

Las imágenes son informativas, sin ningún valor contractual, pudiendo no coincidir con el modelo original. Las condiciones generales de venta están publicadas en nuestra web:

www.celofixings.es

Portes

Los portes serán pagados para importes superiores a:

- 200€ para península, Baleares y Portugal.
- 500€ para Canarias, Andorra, Ceuta y Melilla.
- Pedidos inferiores a 200 € se cargará en factura 15 € en concepto de portes.
- Pedidos inferiores a 120 € se cargará en factura 15 € en concepto de portes y 10 € en concepto de pedido mínimo y administración.

En caso de portes debidos, y salvo indicación expresa por parte del cliente, las mercancías las enviaremos por nuestra agencia de transportes. La recepción de la mercancía supone la aceptación de las condiciones generales de venta.

Condiciones de pago

Los pagos se realizarán a través de giro bancario domiciliado en un periodo de 60 días.

No se admiten fraccionamientos de giro.

Los documentos de pago físicos deberán ser remitidos en un plazo máximo de 30 días posteriores a la fecha de factura.

Cualquier reclamación del comprador sobre la factura, el importe, la forma, el lugar y/o fecha de vencimiento de pago, deberá efectuarse por escrito en el plazo máximo de 15 días posteriores a su recepción. Transcurrido dicho plazo, si el comprador no comunica la conformidad de la factura, se entenderá que el importe y condiciones de pago han sido aceptadas y no se admitirá reclamación alguna.

Los gastos originados por efectos devueltos cuyos motivos no sean imputables a esta sociedad, se repercutirán al cliente en una cuantía del 2,5% del nominal, con un mínimo gasto de 40€ de acuerdo con el artículo 6 Directiva Comunitaria 2011/UE.

Procederemos a la retención automática de pedidos si se produjese algún impagado o demora en la recepción de documentos de pago.

Por renovación de efectos o demora en el pago de los mismos, habrá un cargo en función del tipo de interés oficial (BCE + 8 puntos), de acuerdo con la legislación vigente.

Plazo de entrega

El retraso de los plazos de entrega o fechas previstas no dará lugar a penalización.

Devoluciones

No se aceptan devoluciones de género por:

- Motivos no imputables a CELO.
- Un importe inferior a 50€.

Si, excepcionalmente, se aceptara la devolución por CELO se:



- Notificará y autorizará previamente y el cliente la enviará a portes pagados.
- Adicionalmente se le cargará el coste que se origine en concepto de reempaquetado y del transporte del envío inicial.
- La valoración se hará a fecha de cuando se compró.
- Todo esto supone una depreciación del 30% del valor de la mercancía.

Reclamaciones

Se informará de inmediato en caso de alguna anomalía. No se admiten reclamaciones transcurrido un mes de la fecha de entrega.

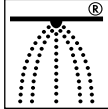

Símbolos y logos usados







SÍMBOLO	EXPLICACIÓN	SÍMBOLO	EXPLICACIÓN
	ETA (Aprobación Técnica Europea) es una homologación de idoneidad técnica de un producto en el ámbito constructivo; en concordancia con la Regulación de Productos Constructivos (CPR) que rige el mercado europeo.		Los productos marcados con el símbolo de aspersor , pueden ser usados para la fijación de elementos de extinción de incendios, bajo techos de hormigón. Estos productos cumplen con la vigente homologación de protección frente al fuego VdS.
	El mercado CE de un producto, informa a los usuarios y autoridades, que el producto comercializado, cumple con la legislación europea obligatoria . Los productos con marcado CE, pueden ser libremente distribuidos dentro del Área Económica Europea.		" Best Nylon Quality " implica que el producto es resistente a la intemperie, gracias al material base poliamida (PA6).
	El mercado Ü (homologación alemana), certifica que el producto cumple con las normativas y especificaciones alemanas para productos del ámbito constructivo. Este marcado es administrado por DIBT (Instituto Alemán de Tecnología de la Construcción)		MS polymers , son adhesivos y sellantes con propiedades excepcionales, para ser utilizados en un amplio rango de aplicaciones.
	El certificado de IFBT (Instituto de Fachadas y Tecnologías de Fijación) , indica que el producto ha sido testeado y técnicamente evaluado para sistemas de fijación de fachadas.		Los productos indicados con este símbolo, son productos de acero inoxidable (A2 o A4) , recomendados para uso en exteriores.
	La resistencia al fuego de un producto , indica el tiempo en minutos durante el cual, dicho producto, mantiene sus funciones y propiedades frente al fuego.		El marcaje LEED , indica que el producto tiene una certificación de sostenibilidad y es respetuoso con el medio ambiente; con baja polución y emisión de partículas.
	Los productos que reflejan este icono, tienen una Aprobación Técnica Europea (ETA) para su uso en elementos de hormigón prefabricado con aligeramientos internos.		La certificación KIWA , indica que el producto o sistema, cumple con pruebas de calidad y certificación, así como en servicios de protección ambiental.
	El producto es adecuado para el uso bajo cargas sísmicas, en acorde a la homologación ETA (Evaluación Técnica Europea) . Existen dos homologaciones frente a cargas sísmicas, C1 o C2; siendo ésta última la más restrictiva.		Émissions dans l'air intérieur es un indicador VOC (Volatil Organic Compunds) que indica el nivel de emisiones para productos de construcción, en base a la normativa ISO 16000. Esta norma evalúa el impacto en la salud de las emisiones producidas por los materiales de construcción.
	UL (Underwriters Laboratories) , es un organismo americano independiente de homologaciones y certificaciones de productos.		RoHS es una directiva de la comunidad europea, orientada a la protección de la salud y la eliminación de sustancias peligrosas en equipos eléctricos y electrónicos. Indica que el anclaje no contiene ninguna sustancia peligrosa.

Fijación

FIJACIONES PARA DIFERENTES APLICACIONES

Taco de nylon FX		28
Taco de nylon F		30
Taco de nylon largo FL		31
Taco multimaterial MZ y MZK		32
Taco nylon para hormigón poroso GB		34
Taco nylon para andamios GR Tornillo para andamios OES		35
Taco metálico MSD		36
Taco de plástico B		37
Taco gran expansión TTIR/TTOR/TGE		38
Taco de plástico cono expansor DNBS		39
Taco de fijación directa MAS		40
Taco de latón ME		41





FIJACIONES DE PREMARCO Y TACOS LARGOS

Taco multimaterial MFR		44
Taco para hueco HBR		47
Taco de golpe NP		49
Taco de golpe NPZ		51
Taco rastrel BN		52
Tornillo y tapón de fijación de premarcos FBS/FBSZ		53
Taco metálico para premarco MR		54











FIJACIONES PLACA DE YESO Y HUECO

Basculante multiuso BT		56
Basculante BE, BG, BS		57
Taco metálico para hueco HRM - MZA 100		58
Taco de nylon para hueco HR		59
Taco para cartón yeso GKD/GKDZ		60
Taco autotaladrante TPL		61







FIJACIONES PARA AISLAMIENTOS

Fijación de aislamiento IPD		64
Tacos para fijar sobre aislamientos IPL		65
Tacos para fijar sobre aislamiento IPL 95DS		66
Tornillo para fijar sobre aislamiento IPS 80		67

FIJACIONES SANITARIAS Y SOPORTE RADIADOR

Fijación vertical WC/FWC		70
Fijación vertical Inox WC/FWC		70
Fijación horizontal WC/FWCH		71
Fijación Cisterna FCIS		71
Fijación horizontal WC/FRH		72
Fijación Lavabo FLTN-H		73
Fijación Termo TA		74
Fijación Calentador TT		75
Fijación Radiador SRR		76
Fijación Radiador SRP		76

ANCLAJES METÁLICOS

Taco clavo expansor para techo DA		78
Anclaje tornillo directo a hormigón BTS5		79
Anclaje tornillo directo a hormigón BTS6		80
Anclaje tornillo directo a hormigón BTS 8/10/14		82
Anclaje metálico antigiro DT, DA, DV, DG		84
Taco hembra cono expansor SAPK/SAP/ESW		86
Anclaje espárrago BA Plus		88
Anclaje espárrago BAZ		89
Anclaje reforzado SLA		91

ANCLAJES QUÍMICOS

ResiFIX® PY – Polyester –		95
ResiFIX® EY – Epoxy –		96
ResiFIX® VY –Vinylester-		96
ResiFIX® VY ECO		97
RESI AST		103
Tamiz plástico SH		104
Tamiz metálico TMR		104
Manguito rosca interior IGH		105
Mezclador MR		105
Bomba soplante BOP y Escobilla PLRBK		105
Pistolas de inyección		106
ResiTHERM® 37/0		107
ResiTHERM® 37		109
Cápsula química VA		113
Espárrago roscado VA AST		114

ADHESIVOS Y SELLANTES

Adhesivo profesional StickFX		116
------------------------------	---	-----

Sujeción









SISTEMA SMART CLAMP

Abrazadera directa a perfil Strut SSC		121
Perfil de fibra Strut SFS		122











ABRAZADERAS PLÁSTICAS Y ACCESORIOS

Abrazadera Abranyl® Classic AN		125
Abrazadera Abranyl® ABT		126
Abrazadera Abranyl® Max ABM		127
Accesorios para abrazadera ABM		128
Abrazadera Abranyl® Doble ABMD		128
Abrazadera con tapa CH		129
Abrazadera Multiclip MC		130
Abrazadera Multiclip UT		131
Abrazadera Saniclip® SC		132
Abrazadera Saniclip® doble SCD		133
Abrazadera multitub MT y MTTE		134

GRAPAS Y BRIDAS PLÁSTICAS





Taco brida rápido InsertFIX		136
Tacobrid TB		137
Brida de nylon CCT		138
Grapa simple de plástico FTS		139
Grapa doble de plástico FTD		140
Clip plástico TCB		141
Plastigrap® PLG		142
Plastigrap® multidiámetro MPLG		143
Basebrid adhesiva BBA		144
Basebrid atornillable BBT		144

ABRAZADERAS METÁLICAS

Abrazadera metálica M6 NK		147
Abrazadera metálica M6 NKS		148
Abrazadera metálica gas M6 GNK		149
Abrazadera metálica M6 L		150
Abrazadera isofónica M6 LI		151
Abrazadera isofónica doble M6 LID		152
Abrazadera metálica doble M6 SD		153
Abrazadera metálica para cables CH		154
Abrazadera metálica doble M6 AD		155
Abrazadera reforzada M8+M10 R		157
Abrazadera reforzada M8 REL		158
Abrazadera reforzada isofónica M8+M10 RI		159
Abrazadera reforzada isofónica M8 RIEL		160
Abrazadera deslizante RID		161
Abrazadera reforzada rápida isofónica M8+M10 RIF		162
Abrazadera reforzada rápida isofónica M8 RIFL		163
Abrazadera isofónica ventilación M8+M10 VIE		164

Abrazadera isofónica ventilación M8 VIEL		165
Abrazadera isofónica altas cargas M12+M16 RIH		166
Abrazadera contra incendios FC		167
Abrazadera para desagües M8 D		168
Soporte EM		169





Grapas y bridas metálicas GRAPAS Y BRIDAS



















Sistema Multigrap GMI/TMG/SMI		172
Grapa metálica F		173
Grapa metálica U		174
Abrazadera sin fin SF		175
Brida flejinox FJX		176
Hebilla flejinox HFX		177
Grapa flejinox GFX		177
Flejadora tornillo FTLL		178
Flejadora palanca FPAL		178
Hebilla inox UAX		179
Cintapolo CA		179
Clip de viga alambre CAL		180
Clip de viga brida CBR		181
Clip de viga varilla CVA		182
Clip de viga abrazadera CAB		183
Clip de viga multifuncional CMV		184
Clip de viga para cable CC		185
Pinza a viga PMV		186

Perfiles y accesorios PERFILES Y ACCESORIOS STRUT

Perfil y soporte Strut 41x21		188
Perfil y soporte Strut 41x41		189
Espárrago perfil deslizante Strut EPS		190
Tuerca rápida TSS		191
Tuerca perfil Strut TS		191
Soporte mural Strut SV		192
Soporte mural Strut SH		192
Placa bloqueo Strut PRS		192
Arandela para perfiles Strut AS		193
Refuerzo consola RC		193
Garra para viga Strut CRAP		194
Escuadra 90° para perfiles Strut ESC		194

PERFILES Y ACCESORIOS





Perfil y soporte 27x18		195
Perfil y soporte 28x30		196
Perfil 30x13		196
Perfil 35x13		197
Perfil 35x18		198
Perfil y soporte 38x40		198

Perfil 40x20		198
Perfil 2000 PG		199
Perfil 2000 PB		199
Perfil 1000 PVC		200
Perfil PO/TPO		200
Perfil multitub PTTR		201
Abrazadera multitub MT y MTTE		201
Espárrago perfil rápido EPR		202
Espárrago perfil EP		203
Tuerca perfil TS		203
Tornillo directo a perfil FTBT		204
Tornillo directo perfil TRBFT		204
Soporte mural SV		205
Soporte mural SH		205
Placa bloqueo PRS		206
Garra para viga CRAP		206
Soporte VT/HT		207
Tapón perfil TPP		207

**Clavadora a gas y accesorios
SECTOR ELÉCTRICO**





































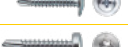

Clavadora a gas FORCE ONE		210
Clavos de acero XHA		211
Bombona gas GASFONE		211
Abrazadera Abranyl® ABT		212
Abrazadera Multiclip UT		213
Base brida TBB		214
Base brida lateral TBBL		214
Base brida dobe TBBD		215
Base brida metálica TBM		215
Base con brida incorporada TBT		215
Arandela plástica Ø 16 mm AP		216
Espárrago roscado ATR		217
Arandela AW		217
Tuerca roscada ATV		218
Sujeción cables TPC - TPLC		219
Grapa de plástico FPD		219
Grapa de plástico FP		220
Abrazadera metálica para mazos de cables CHS		221
Grapa metálica DFT		222
Grapa metálica PFT		222
Sujeción cables WSC /WDC		223
Suspensión cable AAT		223





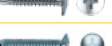

SECTOR CONSTRUCCIÓN

Clavadora a gas FOX		224
Clavos de acero TKA		225
Bombona a gas FOX		225
Cinta textil TXS		226
Arandela plástica Ø 30 mm AP		227

Tornillería

TORNILLOS ROSCA CHAPA

Tornillo DIN 7981		232
Tornillo DIN 7981F		235
Tornillo TORX® 7049		236
Tornillo DIN 7982		237
Tornillo DIN 7982F		239
Tapón estrella zamak TZ		240
Tornillo DIN 7983		241
Tornillo CH88H		242
Tornillo cabeza alomada SIT 7049S		243
Tornillo cabeza avellanada SIT 7061		244
Tornillo cabeza botón BTN		244
Tornillo cabeza reducida FCE		245
Tornillo cabeza extraplana CE		246
Tornillo cabeza extraplana FM		247
Tapón extraplano EFM		247
Tornillo cabeza baja FS		248
Tornillo para tapón NICE		249
Tapón pincho NICEN/NICEC/ NICEB		249
Tornillo cabeza envoltante CAHP		250
Tornillo panel sandwich PG		251
Tapón embellecedor y tapón envoltante T12		251
Tornillo DIN 7981-0		252
Tornillo junquillo ranura CHJ/RJ/ CHJH		253
Tornillo unión de montantes PV70		253
Tornillo broca cabeza extraplana CET		254
Tornillo broca cabeza ancha 75HA		255
Tornillo broca alomado SIT® A85S		256
Tornillo broca avellanado SIT® A61S		257
Tornillo DIN 7504N		258
Tornillo broca reducida ALUN		260
Tapón embellecedor TN		261
Tornillo avellanado DIN 7504P		262
Tornillo DIN 7504K		263
Tornillo 7301		264
Tornillo broca TX inviolable A85TI		265
Tornillo broca botón BTT		266
Tornillo broca cabeza baja FST		267
Tornillo broca reducida ALFST		268
Tornillo broca paso fino HM		269
Tornillo broca reducida ALUH		270

Tornillo matrícula TECPLAS		273270
Punta broca p/montantes PV72		271
Tapón unión de montantes PV71		271
Tornillo para perfil de PVC RH/ KO/VK/TY		271
Tornillo para PVC, rosca chapa punta broca PVS		272
Tornillo para PVC, rosca métrica punta broca PVM		273
Tornillo para PVC, rosca plástico PVP		274

TORNILLOS ROSCA MADERA

Tornillo rosca total madera VELOX® S		278
Tornillo rosca parcial madera VELOX® SP		279
Tornillo rosca total madera VELOX® PZ		280
Tornillo rosca parcial madera VELOX® PZ P		283
Tornillo rosca madera VELOX® B		284
Tornillo rosca madera Inoxidable DIN 7505A		285
Tapón adhesivo MTAP		286
Tornillo para madera DM VELOX® MDF		287
Tornillo de regulación JS		288
Tornillo métrico tirador TIR		288
Tornillo métrico cortable TIRM		289
Tornillo cabeza gota sebo BC		289
Tornillo cabeza reducida BPL		290
Tornillo cabeza ancha CM		290
Tornillo ensamblaje ENE		291
Tornillo doble rosca RA86		291
Tornillo cabeza alomada broca aleta CBTON		292
Maletín tornillería M1		292
Tornillo avellanado broca aleta CBH/CBT		293





TORNILLOS PARA COMPOSITES

Tornillo para fenólico FEC/FEP		294
--------------------------------	---	-----



TORNILLOS PARA ESTRUCTURAS

Tornillo de construcción BMax		295
-------------------------------	---	-----

TORNILLOS ROSCA TIRAFONDO

Tornillo con arandela FTX71		297
Tornillo tirafondo DIN 571		298
Tornillo inox cabeza botón BTW		299
Tornillo inviolable TIC		300

TORNILLOS ROSCA MÉTRICA

Tornillo DIN 7985		302
Tornillo TORX alomado 7985 TX		303
Tornillo DIN 965		304
Tornillo DIN 966		305
Tornillo DIN 84		306
Tornillo DIN 85		307
Tornillo DIN 963		308
Tornillo DIN 933		309
Tornillos estantería E2/E4		310





TUERCAS Y ARANDELAS

Tuerca imperdible COMBY		310
Tuerca DIN 934		311
Tuerca DIN 439		312
Tuerca autoblocante DIN 985 / DIN 6923		312
Tuerca neopreno CFLEX		313
Arandela EPDM 7711 / EPDM 7712		314
Arandela grower DIN 7980 / DIN 127B		314
Arandela de acero DIN125A / DIN 9021		315
Arandela dentada DIN 6798J ADI/ DIN 6798 A ADE		316









TORNILLOS PARA CUBIERTAS Y FACHADAS

Tornillo broca hexagonal cabeza nylon TORN		318
Tornillo hexagonal arandela EPDM CH78		318
Tornillo 7301		319
Tornillo broca larga + EPDM 7331		320
Tornillo hexagonal 7661/7660		320
Tornillo broca larga + EPDM 7361		321
Retén flexible MFL		322
Retén flexible abierto RF		323
Tapón envolvente para tornillos de fachadas o cubiertas TAPEX		323

TORNILLOS ROSCA PLACAS DE YESO

Tornillo cartón yeso chapa SSF		326
Tornillo para placas de yeso GGS		326
Tornillo cartón yeso broca SSB		327
Tornillo para fibrocemento GSH		327















TORNILLERÍA PARA INSTALACIONES

Punta broca cabeza métrica TRB		330
Llave de vaso LLTRB		331
Tornillo con manguito TRBP		331
Tornillo Tornigrap TG		332
Tornillo para grapas TGCA		332
Tornillo cabeza ancha TFC		333
Tornillo tirafondo TF		333
Punta broca AGRP		334
Espárrago doble rosca EDR		335

ACCESORIOS PARA INSTALACIONES

Adaptador BITRO		338
Varilla roscada 975		338
Espárrago unión ESP		339
Espárrago tope ECT		339
Cáncamo CAN		340
Gancho GAN		340
Cáncamo DIN 582		341
Manguito hexagonal MS		341
Manguito cilíndrico MSC		342
Manguito macho / hembra M/H		342
Pistola sellado PCOLA		343
Barra COLA		343
Soporte trapecio TPZ		344
Alcayata roscada ALR		344
Hembrilla abierta HA		345
Hembrilla cerrada HC		345
Clavos acero CPQ		346

PUNTAS Y BROCAS DE ATORNILLAR

Broca standard BST		348
Broca cilíndrica súper BSU		348
Broca SDS Plus		348
Puntas de atornillador PH (Philips)		349
Puntas de atornillador PZ (Pozi)		349
Puntas de atornillador TORX plus®		349
Puntas de atornillador TORX®		350
Puntas de atornillador SIT		350
Puntas de atornillador inviolable TORX®		350
Punta atornillar métrica PH2		351
Llave de vaso hexagonal LV		351
Adaptador magnético DPTOR		351
Remache cabeza alomada RS		352
Remachadora R1		352

AUTOSERVICIO FIJACIÓN

353

AUTOSERVICIO SUJECCIÓN

















363

AUTOSERVICIO TORNILLERÍA







375

PUNTO DE VENTA



391

Fijaciones para cualquier aplicación		Pág.	Hormigón	Piedra	Hormigón Poroso	Ladrillo macizo	Ladrillo Hueco	Bloque Hueco de Hormigón	Cartón Yeso	Tabla madera	Placas de poliestireno	Placas de espuma	Homologación
F		30	●	●	●	●	○	○					
FX		28	●	●	●	●	●	●	○	○			
FL		31	●	●	●	●	●	●					
MZ		32	●	●	●	●	●	●	●	●			
MZK		32	●	●	●	●	●	●	●	●			
NP		49	●	●		●	○	○					
GB		34			●								
B		37	●	●		●	○	○					
TAC		38	●	●		●	○	○					
DNBS		39	●	●		●	○	○					
MAS		40	●	●		●	○	○					
MFR		44	●	●	●	●	●	●					
HBR		47	○	○	○	○	●	●					
OES		35	●	●		●	●	●					





Fijaciones placa de yeso

BT		56					○	○	●	●			
TPL		61							●				
HR		59							●				
GKD - GKDZ		60							●				
HRM		58							●	●			
BG		57					○	○	●	●			

















Fijaciones de premarco y tacos largos

FBS		53	●	●	●	●	○	○					
MR		54	●	●	○	○	○	○					
BN		52	●	●		●							









- Uso recomendado
- Uso funcional

Fijación aislamientos		Pág.	Hormigón	Piedra	Hormigón Poroso	Ladrillo macizo	Ladrillo Hueco	Bloque Hueco de Hormigón	Cartón Yeso	Tabla madera	Placas de poliestireno	Placas de espuma	Homologación
IPD		64	●	●	●	●	●	●					
IPL		65									●	●	
IPS		67									●	●	
IPLD		66									●	●	

Anclajes metálicos

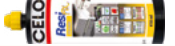
BAZ		89	●	○		○							
SA plus		86	●	○		○							
SLA		91	●	○		○							
BTS		82	●	○		○							
BA plus		88	●	○									
DT		84	●	○	○	○							
ME		41	●	●	●								
NPZ		51	●	●									
DA		78	●	○	○								







Fijaciones Químicas

PY		95	●	●	●	●	●						
EY		96	●	●	●	●	●						
VY		96	●	●	●	●	●						
VA		113	●	○									

Adhesivos y sellantes

MS HT		116	●	●	●	●	●						
-------	---	-----	---	---	---	---	---	--	--	--	--	--	--

Fijaciones sanitarias

FWC		70	●	●	●	●	●	●	●				
FWCH		71	●	●	●	●	●	●	●				
FLTN		73	●	●	●	●	●	●	●				
TT		75	●	●	●	●	●	●	●				
TA		74	●	●	●	●	●	●	●				
FRH		72	●	●	●	●	●	●	●				

Notas

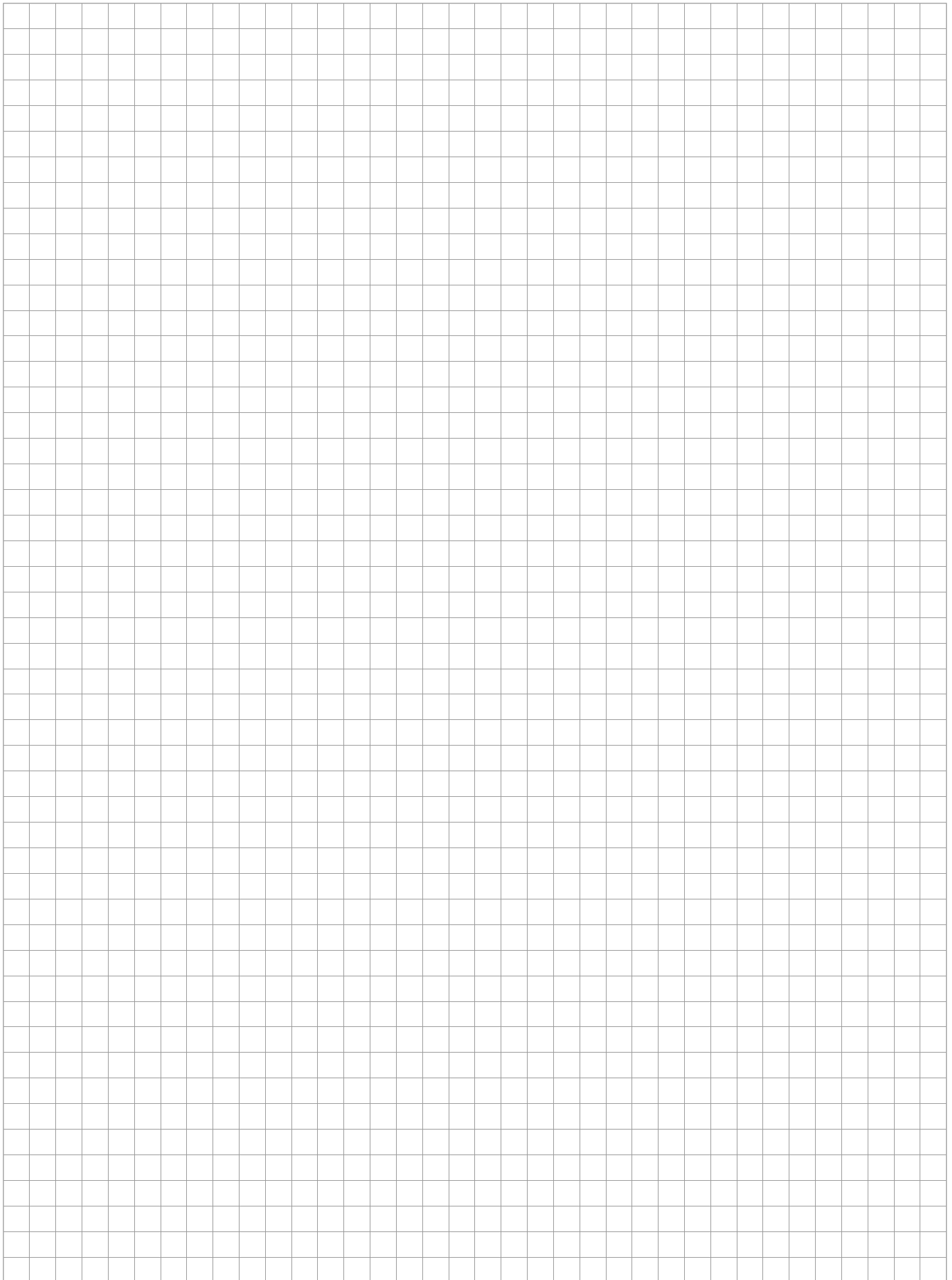

Fijación

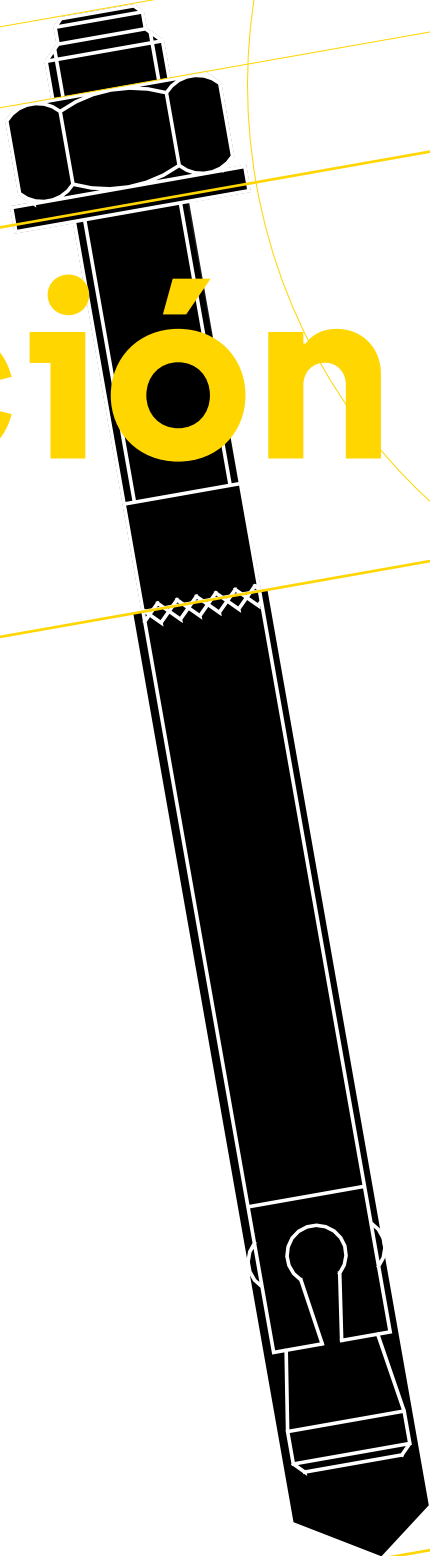

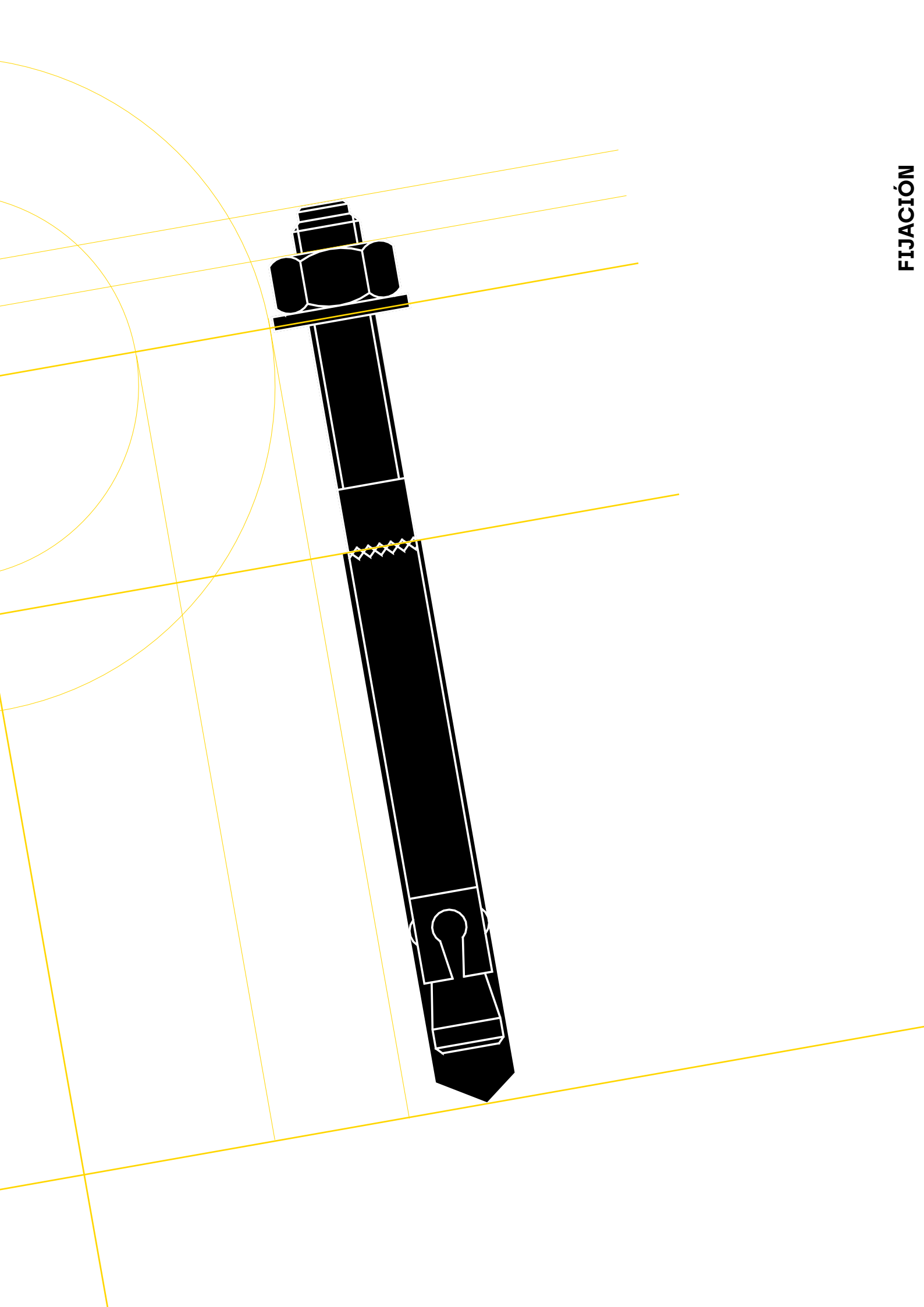



Notas

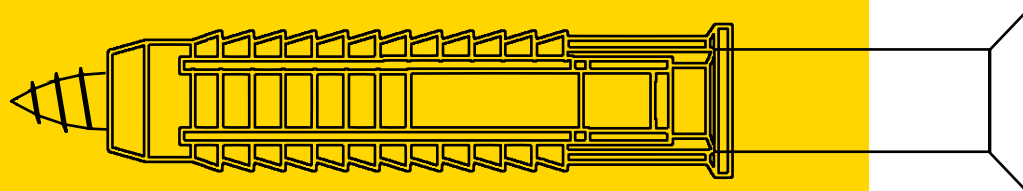

Fijaciones para diferentes aplicaciones

Taco de nylon FX	28
Taco de nylon F	30
Taco de nylon largo FL	31
Taco multimaterial MZ y MZK	32
Taco nylon para hormigón poroso GB	34
Taco nylon para andamios GR/OES	35
Taco metálico MSD	36
Taco de plástico B	37
Taco gran expansión TTIR/TTOR/TGE	38
Taco de plástico con cono expansor DNBS	39
Taco de fijación directa MAS	40
Taco de latón ME	41

Taco de nylon FX



Características

- Expansión cuádruple para conseguir mejores valores de extracción.
- Compatible con diferentes tipos de tornillo como rosca madera, rosca chapa, rosca tirafondo, etc.
- Aletas antirotación para evitar el giro.
- Con collarín para evitar que se cuele.
- Estriado en las cuatro caras, mayor agarre.
- Soporta temperaturas entre -40 °C a +80 °C.

Adecuado para materiales

- Hormigón
- Piedra
- Ladrillo macizo
- Hormigón poroso
- Bloque hueco
- Ladrillo hueco
- Cartón yeso

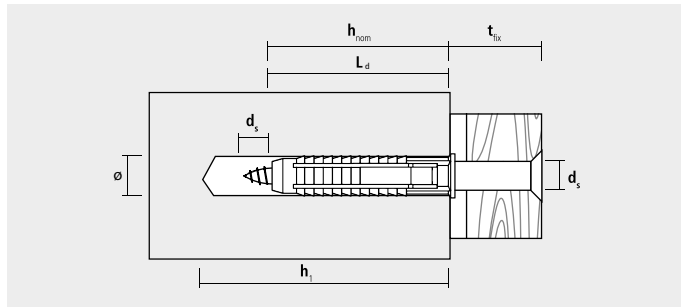

Instalación

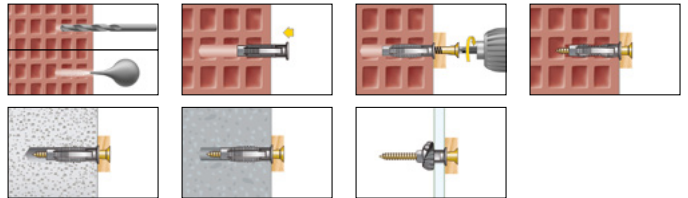

Cajas

FX Sin tornillo					Precios		Envase	Embalaje
Ø [mm]	h ₁ ≥ [mm]	h _{nom} ≥ [mm]	L _d [mm]	d _s [mm]	Código	Precio €/100 u.	(Uds.)	(Uds.)
5	35	25	25	2,5 - 4	95FX	5,70	100	6000
6	40	30	30	3,5 - 5	96FX	6,20	100	6000
8	55	40	40	4,5 - 6	98FX	10,30	100	2700
10	70	50	50	6 - 8	910FX	17,50	50	1350
12	80	60	60	8 - 10	912FX	31,10	25	675

FX* Con tornillo					Precios		Envase	Embalaje
Ø [mm]	h ₁ ≥ [mm]	h _{nom} ≥ [mm]	L _d [mm]	d _s [mm]	Código	Precio €/100 u.	(Uds.)	(Uds.)
6	40	30	30	4,5 x 45	96FXSZ	19,80	50	3000
8	55	40	40	5,0 x 60	98FXSZ	37,50	50	1350
10	70	50	50	7,0 x 65	910FXK	70,20	25	675

¹ Longitud del tornillo.
* FX con tornillo avellanado (FX6 y FX8 en PZ2), con tornillo hexagonal (FX10 en SW13).

Blisters

FX Sin tornillo		Precios		Envase	Embalaje	Embalaje
Ø mm	Código	Precio €/Blister	(Uds.)	(Uds.)	(Blister)	(Uds.)
5	55FX50	5,20	50	10	500	
6	56FX30	5,20	30	10	300	
8	58FX20	5,20	20	10	200	
10	510FX10	5,20	10	10	100	
12	512FX6	5,20	6	10	60	

FX* Con tornillo		Precios		Envase	Embalaje	Embalaje
Ø mm	Código	Precio €/Blister	(Uds.)	(Uds.)	(Blister)	(Uds.)
6	56FXSZ15	6,00	15	10	150	
8	58FXSZ10	6,00	10	10	100	
10	510FXK5	6,00	5	10	50	

¹ Longitud del tornillo.
* FX con tornillo avellanado (FX6 y FX8 en PZ2), con tornillo hexagonal (FX10 en SW13).

Cargas recomendadas F_{Rec} [kN]

Ø [mm]	Hormigón C20/25 F _{Rec} [kN]	Bloque hueco KSL 12 F _{Rec} [kN]	Ladrillo macizo MZ12 F _{Rec} [kN]	Hormigón poroso P2 F _{Rec} [kN]	Hormigón poroso P4 F _{Rec} [kN]	Ladrillo hueco HLZ 12 F _{Rec} [kN]
4	0,20	0,21	0,21	0,03	0,05	0,15
5	0,47	0,42	0,42	0,05	0,10	0,20
6	0,52	0,50	0,50	0,10	0,14	0,23
8	1,28	0,90	0,90	0,16	0,30	0,45
10	1,91	1,10	1,10	0,28	0,40	0,50



F_{Rec}: Carga recomendada con factor de seguridad (μ = 7). Al utilizar tornillos para aglomerados, los valores deben reducirse en un 40%.

Expositor punto de venta FX

Tacos FX envasados en bote de plástico

- Cómodo, resistente a la humedad, reutilizable, fácil de transportar y apilable.

Botes

FX Sin tornillo	Precios		Envase	Embalaje
Ø [mm]	Código	Precio €/Bote	 (Uds.)	 (Uds.)
6	96EXPFX	18,50	300	10
8	98EXPFX	12,40	125	10
10	910EXPFX	12,20	70	10

Tapa de plástico fácil de abrir.

Indicación de la cantidad e identificación del producto.

Foto y medidas de los productos del interior.



FIJACIÓN

Expositor sobre mostrador



Capacidad: 40 botes
Exp. Código: DISPENSADORFX

Taco de nylon F



Características

- Apertura lateral para ofrecer una mayor expansión.
- Interior con guía direccional que centra, evita el giro y expansión en el inicio de roscado.
- 4 aletas antigiro.
- Su resistente diseño evita que se doble cuando se inserta con un martillo.

Adecuado para materiales

- Hormigón
- Piedra
- Ladrillo macizo
- Hormigón poroso

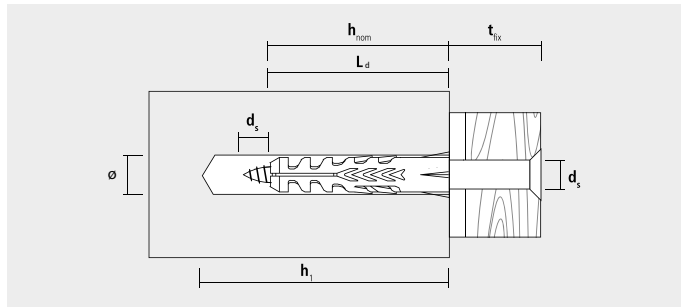

Instalación

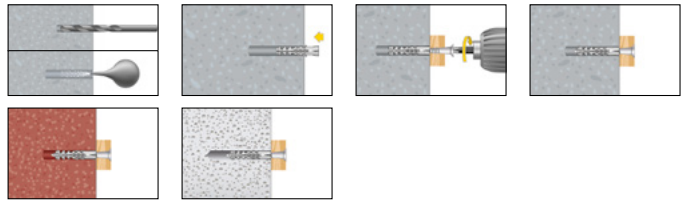

Cajas

F					Precios		Envase	Embalaje
Ø [mm]	h ₁ ≥ [mm]	h _{nom} ≥ [mm]	L _d [mm]	d _s [mm]	Código	Precio €/100 u.	(Uds.)	(Uds.)
4	30	20	20	2 - 3	94NF	3,60	200	12000
5	35	25	25	2,5 - 4	95NF	3,80	100	6000
6	40	30	30	3,5 - 5	96NF	3,90	100	6000
7	40	30	30	4 - 5,5	97NF	5,90	50	3000
8	55	40	40	4,5 - 6	98NF	7,60	100	2700
10	70	50	50	6 - 8	910NF	13,50	50	1350
12	80	60	60	8 - 10	912NF	24,30	25	675
14	90	70	70	10 - 12	914NF	40,30	20	540
16	100	80	80	12 - 14	916NF	63,60	10	270
20	120	90	90	16	920NF	130,50	5	135

Blisters

F		Precios		Envase	Embalaje	Embalaje
Ø [mm]	Código	Precio €/Blister		(Uds.)	(Blister)	(Uds.)
4	54NF20	2,60		20	10	200
5	55NF20	2,60		20	10	200
6	56NF20	2,60		20	10	200
7	57NF20	2,60		20	10	200
8	58NF20	2,60		20	10	200
10	510NF5	4,70		5	10	50
12	512NF5	4,70		5	10	50

Cargas recomendadas F_{Rec} [kN]

Ø [mm]	Hormigón C20/25		Caliza KSL 12		Ladrillo macizo MZ12		Hormigón poroso P2		Hormigón poroso P4		Ladrillo hueco HLZ 12	
	F _{Rec} [kN]	F _{Eff} [kN]	F _{Rec} [kN]	F _{Eff} [kN]	F _{Rec} (kN)	F _{Eff} [kN]	F _{Rec} (kN)	F _{Eff} [kN]	F _{Rec} (kN)	F _{Eff} [kN]	F _{Rec} (kN)	F _{Eff} [kN]
3	0,12	0,83	0,14	0,98	0,14	0,97	-	-	-	-	0,08	0,56
4	0,23	1,64	0,33	2,28	0,24	1,66	0,04	0,31	0,04	0,26	0,09	0,61
5	0,31	2,18	0,37	2,60	0,38	2,63	0,05	0,32	0,06	0,40	0,12	0,87
6	0,34	2,35	0,43	3	0,46	3,24	0,07	0,49	0,07	0,46	0,13	0,88
8	0,77	5,37	0,78	5,47	0,79	5,54	0,1	0,7	0,1	0,73	0,22	1,53
10	1,55	10,83	1,9	13,33	1,57	11	0,15	1,05	0,16	1,14	0,3	2,09
12	2,71	29,02	-	-	-	-	-	-	0,28	1,99	0,43	3,04
16	5,5	38,5	-	-	-	-	-	-	-	-	-	-

F_{Rec}: Carga recomendada con factor de seguridad (μ = 7).

F_{Eff}: Carga de rotura real sin factor de seguridad. Al utilizar tornillos para aglomerados, los valores deben reducirse en un 40%.

Taco de nylon largo FL



FL 6-60, 8-80, 10-90



FL 8-100, 8-120



FIJACIÓN

Características

- Área de expansión larga para fijaciones que requieran anclajes profundos en materiales macizos o huecos.
- Exclusiva área de expansión permite que se pueda utilizar tanto en macizo como en hueco.
- Soporta temperaturas entre -40 °C a +80 °C.
- Múltiples aletas para evitar la rotación al atornillar.
- Sin collarín para utilizarse en fijaciones pasantes.

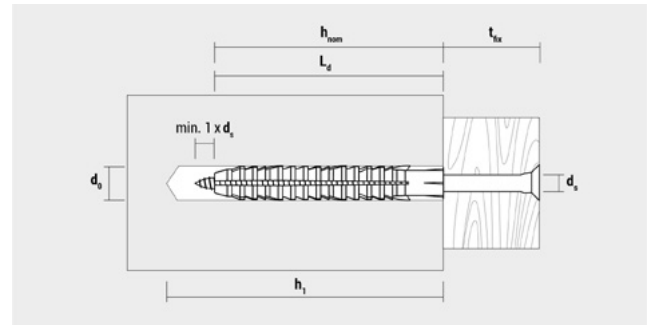

Adecuado para materiales

- Hormigón
- Piedra
- Ladrillo macizo
- Ladrillo hueco
- Hormigón poroso
- Bloque

Instalación

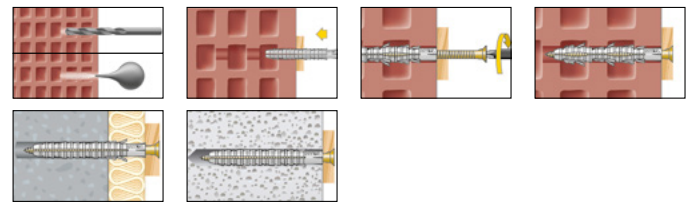

Cajas

FL					Precios		Envase	Embalaje
Ø [mm]	h _z [mm]	h _{nom} [mm]	L _e [mm]	d _s [mm]	Código	Precio €/100 u.	Uds.	Uds.
6	70	60	60	3,5 - 4,5	9660FL	14,00	100	2700
8	90	80	80	4,5 - 5,5	9880FL	17,50	50	600
8	90	80	100	4,5 - 5,5	98100FL	30,50	50	600
8	90	80	120	4,5 - 5,5	98120FL	48,00	50	600
10	105	90	90	6 - 7	91090FL	29,70	25	300

Blisters

FL	Precios		Envase	Embalaje	Embalaje
Ø [mm]	Código	Precio €/Blister	Uds.	(Blisters)	Uds.
6	5660FL10	5,10	10	10	100
8	5880FL10	5,10	10	10	100
10	51090FL5	5,10	5	10	50

Cargas recomendadas F_{Rec} [kN]

Ø Tornillo [mm]	Hormigón C20/25	Hormigón poroso P2	Hormigón poroso P4	Hormigón poroso P6	Bloque KSL 12	Ladrillo hueco HLZ 12
	F _{Rec} [kN]	F _{Rec} [kN]	F _{Rec} [kN]	F _{Rec} [kN]	F _{Rec} [kN]	F _{Rec} [kN]
4,5	0,17	0,05	0,07	0,15	0,13	0,10
5,5	0,33	0,09	0,14	0,30	0,15	0,12
5,5	0,33	0,09	0,14	0,30	0,15	0,12
5,5	0,33	0,09	0,14	0,30	0,15	0,12
7	0,56	0,19	0,25	0,33	0,22	0,20

F_{Rec}: Cargas recomendadas con factor de seguridad incluido (μ = 7).
 En materiales sólidos solo se puede utilizar con la profundidad de anclaje reducida o tornillos de pequeño diámetro.
 Al utilizar tornillos para aglomerado, los valores deben reducirse en un 30%.

Taco multimaterial MZ y MZK



MZ sin valona



MZK con valona



Características

- Área de expansión larga para fijaciones que requieran anclajes profundos en materiales macizos o huecos.
- Exclusiva área de expansión permite que se pueda utilizar tanto en macizo como en hueco.
- Soporta temperaturas entre -40 °C a +80 °C.
- Múltiples estrías para evitar la rotación al atornillar.
- Sin collarín para utilizarse en fijaciones pasantes.

Adecuado para materiales

- Hormigón
- Piedra
- Ladrillo macizo
- Hormigón poroso
- Ladrillo hueco
- Cartón yeso
- Listones de madera

Cajas

MZ Sin valona						Precios		Envase	Embalaje
Ø [mm]	h ₁ ≥ [mm]	h _{nom} ≥ [mm]	L _d [mm]	H _{Min} ¹ [mm]	d _s [mm]	Código	Precio €/100 u.	(Uds.)	(Uds.)
6	40	29	29	7	3 - 4,5	96MZ	6,50	100	6000
6	50	40	40	7	3 - 4,5	9640MZ	7,30	100	4800
8	60	48	48	9,5	3,5 - 6	98MZ	9,30	100	1800
10	75	59	59	12	6 - 8	910MZ	17,20	50	900
12	85	71	71	15	8 - 10	912MZ	33,00	50	600
14	95	75	75	15	10 - 12	914MZ	50,80	25	300

¹ Min: Espesor mínimo para cartón yeso.

MZK Con valona						Precios		Envase	Embalaje
Ø [mm]	h ₁ ≥ [mm]	h _{nom} ≥ [mm]	L [mm]	H _{Min} ¹ [mm]	d _s [mm]	Código	Precio €/100 u.	(Uds.)	(Uds.)
6	40	29	30	7	3 - 4,5	96MZK	6,60	100	4800
6	50	40	41	7	3 - 4,5	9641MZK	8,10	100	2700
8	60	48	49	9,5	3,5 - 6	98MZK	9,90	100	1800
10	75	59	60	12	6 - 8	910MZK	17,60	50	900
12	85	71	72	15	8 - 10	912MZK	34,60	50	600
14	95	75	76	15	10 - 12	914MZK	52,40	25	300

¹ Min: Espesor mínimo para cartón yeso.

MZK Con valona y tornillo						Precios		Envase	Embalaje
Ø [mm]	h _{1s} [mm]	h _{nomz} [mm]	L [mm]	H _{Min} ¹ [mm]	d _s x L _s ⁽²⁾	Código	Precio €/100 u.	(Uds.)	(Uds.)
6	40	29	30	7	4,5 x 45	96MZKSZ	20,20	50	2400
6	50	40	41	7	4,5 x 50	9641MZKSZ	25,60	50	1350
8	60	48	49	9,5	5,0 x 70	98MZKSZ	45,50	50	900
10	75	59	60	12	6,0 x 80	910MZKZ	75,90	25	450

¹ Min: Espesor mínimo para cartón yeso.

² Longitud del tornillo.

Incluye tornillo avellanado PZ2 (MZK 6, 6-41,8) y tirafondo (MZK 10).

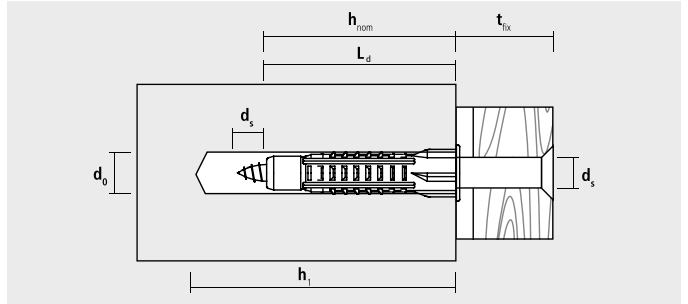
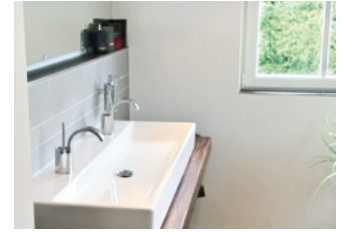

Instalación

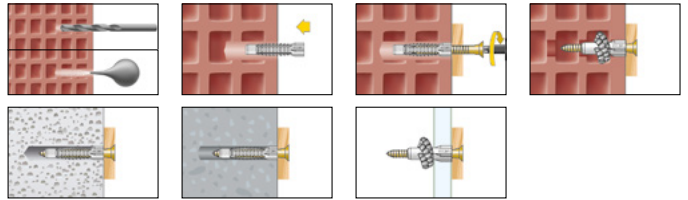

Blisters

MZ Sin valona		Precios		Envase	Embalaje	Embalaje
Ø [mm]	Código	Precio €/Blister	(Uds.)	(Blisters)	(Uds.)	(Uds.)
6	56MZ20	4,40	20	10	200	200
6	5640MZ10	4,40	10	10	100	100
8	58MZ15	4,40	15	10	150	150
10	510MZ10	4,40	10	10	100	100
12	512MZ5	4,40	5	10	100	100

MZK Con valona		Precios		Envase	Embalaje	Embalaje
Ø [mm]	Código	Precio €/Blister	(Uds.)	(Blisters)	(Uds.)	(Uds.)
6	56MZK20	4,40	20	10	200	200
6	5641MZK10	4,40	10	10	100	100
8	58MZK15	4,40	15	10	150	150
10	510MZK10	4,40	10	10	100	100

MZK Con valona y tornillo		Precios		Envase	Embalaje	Embalaje
Ø [mm]	Código	Precio €/Blister	(Uds.)	(Blisters)	(Uds.)	(Uds.)
6	56MZKSZ20	5,60	20	10	200	200
6	5641MZKSZ10	5,60	10	10	100	100
8	58MZKSZ8	5,60	8	10	80	80
10	510MZKZ5	5,60	5	10	50	50

Botes

MZK		Precios		Envase	Embalaje	Embalaje
Ø [mm]	Código	Precio €/Bote	(Uds.)	(Bote)	(Uds.)	(Uds.)
6	9641EXPMZK	17,90	200	10	2000	2000
8	98EXPMZK	10,00	90	10	900	900
10	910EXPMZK	9,70	50	10	500	500
12	912EXPMZK	9,60	25	10	250	250

Cargas recomendadas F_{Rec} [kN] con tirafondo

	Ø Tornillo [mm]	Hormigón C20/25		Bloque calcáreo macizo KSV 12		Ladrillo macizo MZ 12		Hormigón poroso P2		Ladrillo hueco HLZ 12		Cartón yeso 12,5 mm		Tablero 16 mm	
		F_{Rec} [kN]	F_{Eff} [kN]	F_{Rec} [kN]	F_{Eff} [kN]	F_{Rec} [kN]	F_{Eff} [kN]	F_{Rec} [kN]	F_{Eff} [kN]	F_{Rec} [kN]	F_{Eff} [kN]	F_{Rec} [kN]	F_{Eff} [kN]	F_{Rec} [kN]	F_{Eff} [kN]
MZ/MZK 6	4,5	0,30	2,08	0,26	1,81	0,16	1,09	0,04	0,30	0,22	1,57	0,06	0,45	0,21	1,47
MZ/MZK 6-41	4,5	0,52	5,03	0,51	3,54	0,27	1,90	0,06	0,43	0,21	1,44	0,08	0,57	0,15	1,05
MZ/MZK 8	6	0,72	3,64	0,59	4,10	0,43	3,03	0,11	0,77	0,27	1,90	0,09	0,63	0,23	1,58
MZ/MZK 10	8	1,56	10,90	1,07	7,50	0,68	4,78	0,13	0,94	0,31	2,15	0,08	0,58	0,25	1,72
MZ/MZK 12	10	2,02	14,12	1,31	9,20	-	-	0,23	1,63	0,42	2,92	0,11	0,74	0,37	2,56
MZ/MZK 14	12	2,27	-	-	-	-	-	0,37	2,59	0,33	2,31	0,09	-	0,30	-

F_{Rec} : Carga recomendada con factor de seguridad ($\mu = 7$), con tornillo de diámetro grande y profundidad de anclaje completo.

F_{Eff} : Carga de rotura real sin factor de seguridad.

Cargas recomendadas F_{Rec} [kN] con tornillos de rosca aglomerado.

	Ø Tornillo [mm]	Hormigón C20/25		Bloque calcáreo macizo KSV 12		Ladrillo macizo MZ 12		Hormigón poroso P2		Ladrillo hueco HLZ 12		Cartón yeso 12,5 mm		Tablero 16 mm	
		F_{Rec} [kN]	F_{Eff} [kN]	F_{Rec} [kN]	F_{Eff} [kN]	F_{Rec} [kN]	F_{Eff} [kN]	F_{Rec} [kN]	F_{Eff} [kN]	F_{Rec} [kN]	F_{Eff} [kN]	F_{Rec} [kN]	F_{Eff} [kN]	F_{Rec} [kN]	F_{Eff} [kN]
MZ/MZK 6	4,5	0,06	0,39	0,06	0,44	0,05	0,38	0,02	0,17	0,08	0,56	0,03	0,23	0,14	1,00
MZ/MZK 6-41	4,5	0,17	1,19	0,15	1,05	0,08	0,58	0,04	0,26	0,17	1,20	0,09	0,61	0,21	1,55
MZ/MZK 8	6	0,24	1,71	0,24	1,67	0,21	1,49	0,06	0,40	0,26	1,81	0,09	0,62	0,29	2,06
MZ/MZK 10	6 ¹	0,17	1,22	0,17	1,18	0,16	1,09	0,07	0,50	0,35	2,45	0,10	0,69	0,29	2,02

F_{Rec} : Carga recomendada con factor de seguridad ($\mu = 7$), con tornillo de diámetro grande y profundidad de anclaje completo.

F_{Eff} : Carga de rotura real sin factor de seguridad.

¹ Cuando se utiliza tornillos Ø 6 mm

Taco nylon para hormigón poroso GB



Características

- La fuerza se transmite a través de los tres ángulos de forma homogénea.
- Cuando el taco es insertado, los segmentos laterales aseguran una gran fijación inicial.
- Ideal en materiales donde otros tacos giran.

Adecuado para materiales

- Hormigón poroso
- Piedra calcárea
- Marés media y baja densidad

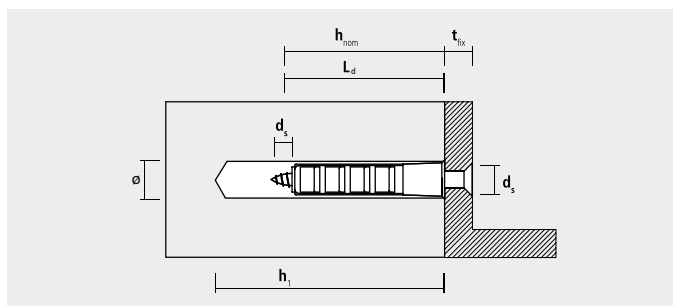

Instalación

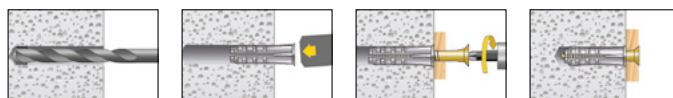

Cajas

GB					Precios		Envase	Embalaje
Ø [mm]	h ₁ ≥ [mm]	h _{nom} ≥ [mm]	L _d [mm]	d _s [mm]	Código	Precio €/100 u.	(Uds.)	(Uds.)
10	65	55	55	4,5 - 6	910GB	56,80	25	675
12	70	60	60	7-8	912GB	79,70	20	540
14	90	75	75	10	914GB	112,00	10	270

* Todas las medidas de GB pueden instalarse en agujeros más pequeños en hormigón poroso P4.

** El taco GB 10 se puede fijar directamente sin taladro previo para la calidad P2.

Cargas recomendadas F_{Rec} [kN]

Tipo	Tornillo madera - Ø [mm]	Hormigón poroso P2	Hormigón poroso P4
		F _{Rec} [kN]	F _{Rec} [kN]
GB 10	6	0,25	0,55
GB 12	7	0,33	0,66
GB 14	10	0,50	1,10

Taco nylon para andamios GR Tornillo para andamios OES

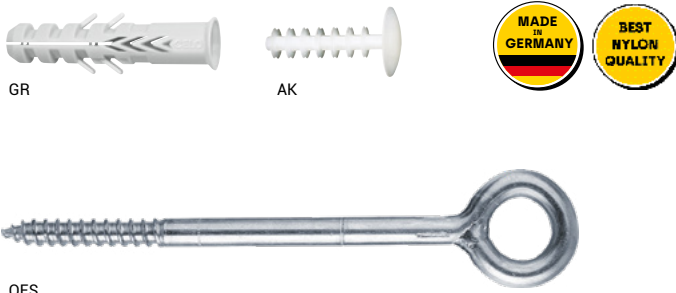

FIJACIÓN

Características

- Apto para todas las fijaciones de andamios en macizo según DIN 4420.
- Soporta temperaturas entre -40 °C a +80 °C.
- La combinación del taco GR con el tornillo OES consigue las máximas cargas.
- La marca en el tornillo OES ayuda a una correcta instalación.
- Tapón AK disponible para sellar el agujero.

Adecuado para materiales

- Hormigón
- Piedra natural
- Ladrillo macizo

Cajas

GR					Precios		Envase	Embalaje
∅ [mm]	h ₁ ≥ [mm]	h _{nom} ≥ [mm]	L _d [mm]	t _{fix} ≤ [mm]	Código	Precio €/100 u.	(Uds.)	(Uds.)
14	90	70	70	0	91470GR	64,00	40	320
14	90	70	100	30	914100GR	77,70	40	320
14	90	70	135	65	914135GR	89,40	40	320
14	90	70	185	115	914185GR	97,60	40	320

OES			Precios		Envase	Embalaje
∅ [mm]	L _s [mm]	d _{oes} [mm]	Código	Precio €/100 u.	(Uds.)	(Uds.)
12	90	23	91290OES	330,90	20	60
12	120	23	912120OES	354,60	20	60
12	160	23	912160OES	401,90	20	60
12	190	23	912190OES	449,20	20	60
12	230	23	912230OES	458,50	20	60

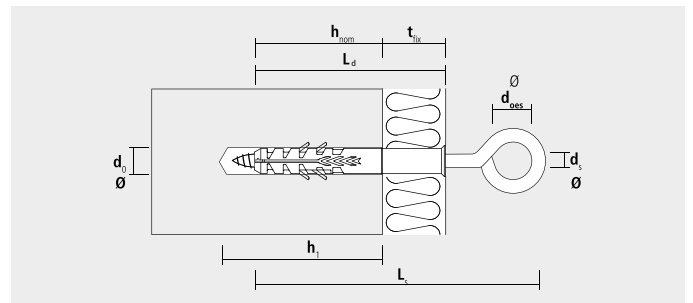

Instalación

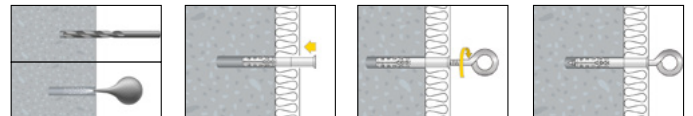

AK tapón Ø27 mm para GR		Precios		Envase	Embalaje
∅ [mm]	L [mm]	Código	Precio €/100 u.	(Uds.)	(Uds.)
27	53	91AKGR	24,90	50	600

Cargas recomendadas F _{Rec} [kN]	Hormigón C20/25	Ladrillo macizo MZ 12	Arenisca calcárea Ladrillo macizo KSV 12
	F _{Rec} [kN]	F _{Rec} [kN]	F _{Rec} [kN]
GR 14	3,00	2,8	3,00

F_{Rec}: Carga recomendada con factor de seguridad (μ = 4).

Taco metálico MSD



Características

- Adecuado para la fijación de tuberías de agua caliente y abrazaderas metálicas.
- Cumple con la directriz (TRGI 3.3.7.2) de instalación de gas, cuando se instala con EDR.
- La superficie dentada asegura una buena fijación en cualquier material.

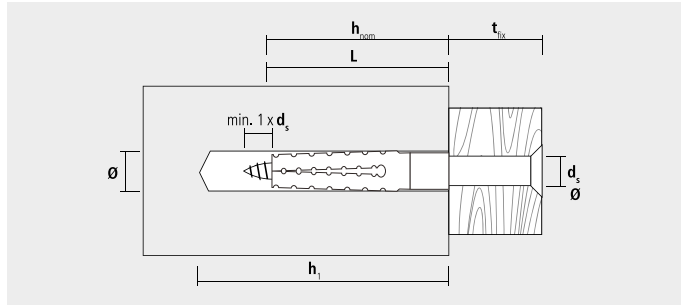

Adecuado para materiales

- Hormigón
- Caliza
- Ladrillo macizo
- Bloque macizo
- Hormigón poroso

Instalación

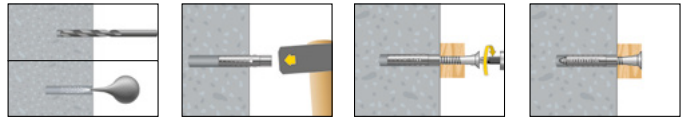

Cajas

MSD					Precios		Envase	Embalaje
\emptyset [mm]	$h_1 \geq$ [mm]	$h_{nom} \geq$ [mm]	L [mm]	d_s [mm]	Código	Precio €/100 u.	(Uds.)	(Uds.)
7 - 9*	38	32	32	5 - 6	9B632MSD	24,50	100	2000
10 - 12*	46	38	38	6 - 8	9B838MSD	35,50	100	2000
10 - 12*	68	60	60	6 - 8	9B860MSD	51,20	50	1000

* Depende del material base.

Cargas recomendadas F_{Rec} [kN]

\emptyset [mm]	Hormigón C20/25		Bloque macizo		Ladrillo macizo MZ 12		Hormigón poroso P2		Hormigón poroso P4		Piedra pómez		Ladrillo hueco HLZ 12	
	\emptyset [mm]	F_{Rec} [kN]	\emptyset mm	F_{Rec} [kN]	\emptyset [mm]	F_{Rec} [kN]	\emptyset [mm]	F_{Rec} [kN]	\emptyset [mm]	F_{Rec} [kN]	\emptyset [mm]	F_{Rec} [kN]	\emptyset [mm]	F_{Rec} [kN]
7 - 9*	9	0,25	8	0,20	8	0,20	-	0,10	7	0,20	5	0,15	7	0,15
10 - 12*	12	0,30	11	0,30	11	0,30	-	0,20	10	0,35	6	0,20	10	0,25
10 - 12*	12	0,55	11	0,50	11	0,50	6	0,30	10	0,45	6	0,30	10	0,30

Taco de plástico B



FIJACIÓN

Características

- Pensado para espesores de pared finas.
- Gran expansión.

Adecuado para materiales

- Ladrillo
- Piedra
- Hormigón
- Bloque

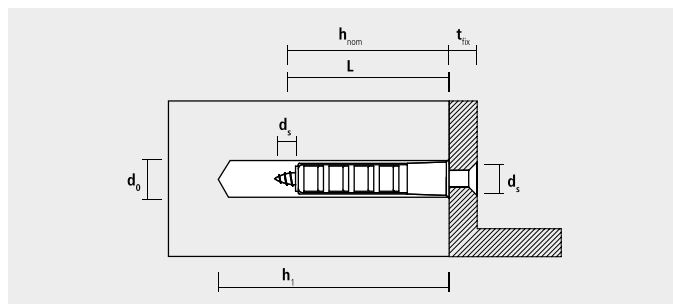

Cajas

B				Precios		Envase	Embalaje
\varnothing [mm]	h_1 [mm]	L [mm]	d_s [mm]	Código	Precio €/100 u.	 (Uds.)	 (Uds.)
5	23	18	2,5-3	915B	2,90	500	4500
6	27	22	3-3,5	916B	3,70	500	4500
7	29	24	3,5-4	917B	4,40	500	4500
8	32	27	4-4,5	918B	5,20	500	4500
9	34	29	4-4,5	919B	7,00	500	3000
10	44	34	4-5	9110B	9,80	200	1800

Taco gran expansión TTIR / TTOR / TGE

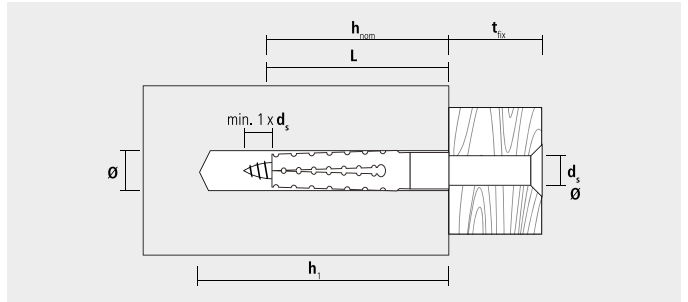
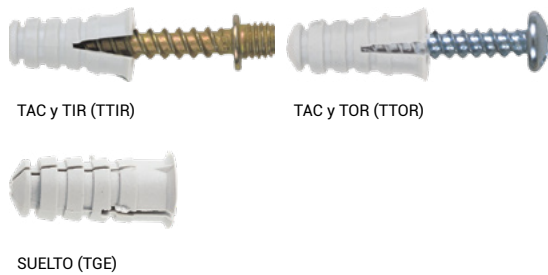

Características

- Doble expansión, abre y aprieta desde el inicio.
- TAC y TOR incluye TG30.
- TAC y TIR incluye TF M6x25.
- Longitud reducida, buena resistencia (50 kg en hormigón 20/25).

Instalación

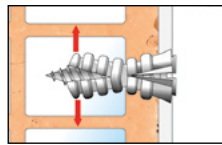

Taco fijado con doble expansión

Adecuado para materiales

- Tabique fino
- Ladrillo hueco

Cajas

TTIR / TTOR / TGE					Precios		Envase	Embalaje
Ø [mm]	h ₁ ≥ [mm]	h _{nom} ≥ [mm]	L [mm]	d _s [mm]	Código	Precio €/100 u.	(Uds.)	(Uds.)
8	35	25	25	-	98TTOR	18,30	200	1800
8	35	25	25	M6	98TTIR	20,50	200	1800
8	35	25	25	-	98TGE	8,00	200	3600

Taco de plástico cono expansor DNBS



Suelto

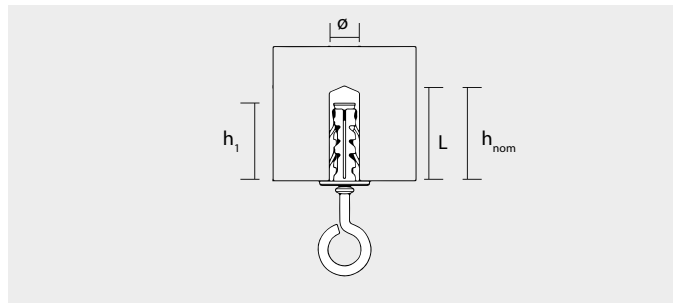

FIJACIÓN

Características

- Taco con doble antigiro.
- Especial para tabiques y bovedilla cerámica.
- Recomendado para bajar varilla en material hueco.
- Cono de latón M4 para evitar aflojamientos.

Adecuado para materiales

- Hormigón alveolar
- Tabique fino
- Ladrillo hueco
- Bloque hueco

Instalación

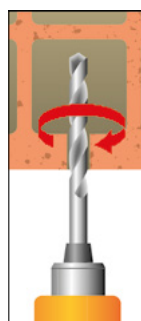

Taladrar

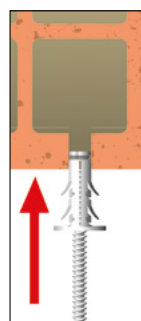

Insertar con varilla M-4

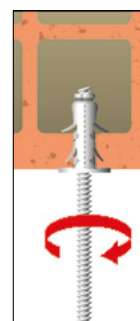

Tirar fuerte para abrir taco

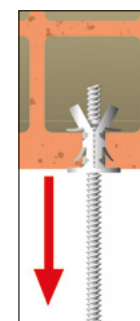

Taco expansionado

Cajas

DNBS				Precios		Envase	Embalaje
Ø [mm]	L [mm]	h ₁ [mm]	Rosca	Código	Precio €/100 u.	(Uds.)	(Uds.)
30	8	35	M4	9830DNBS	37,30	100	1800

Taco de fijación directa MAS



Características

- Pensado para espesores de pared finas.
- Gran expansión.

Adecuado para materiales

- Hormigón
- Ladrillo macizo
- Ladrillo hueco

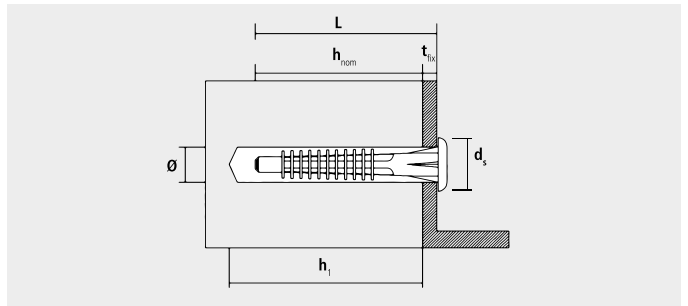

Instalación

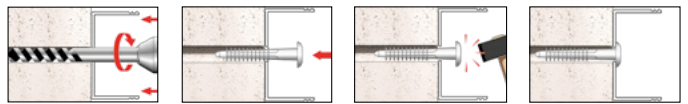

Taladrar $\varnothing 5 / \varnothing 6$

Insertar el taco.

Golpear el taco.

La canaleta queda fijada.

Cajas

MAS Blanco					Precios		Envase	Embalaje
d_0 [mm]	$h_1 \geq$ [mm]	$h_{nom} \geq$ [mm]	L [mm]	d_s [mm]	Código	Precio €/100 u.	 (Uds.)	 (Uds.)
5	35	25	30	2,5-4	91530MAS	9,40	200	1600
6	40	32	40	3,5-5	91640MAS	12,70	200	1600
6	65	52	65	3,5-5	91665MAS	16,60	100	800

Taco de latón ME

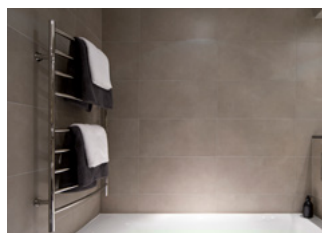
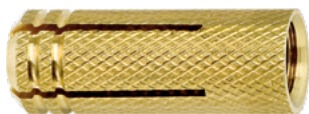

FIJACIÓN

Características

- Expansión por roscado de tornillo o varilla.
- No necesita expansionador.
- Resistente a la corrosión.

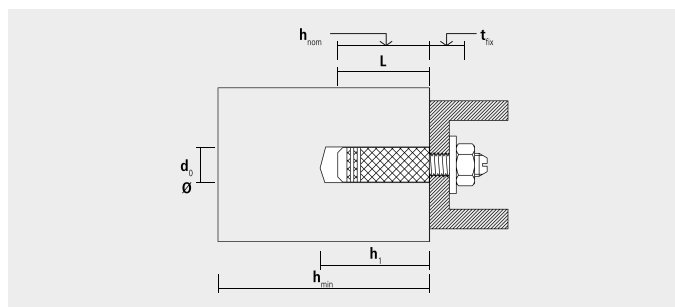

Adecuado para materiales

- Hormigón
- Ladrillo macizo
- Piedra caliza
- Piedra natural

Instalación

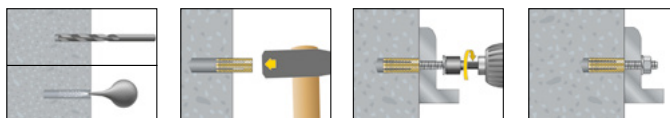

Cajas

ME				Precios		Envase	Embalaje
Ø [mm]	h ₁ ≥ [mm]	h _{nom} ≥ [mm]	Rosca	Código	Precio €/100 u.	(Uds.)	(Uds.)
5	18	16	M 4	9L4ME	27,90	100	3200
8	27	23	M 6	9L6ME	41,40	100	4000
10	35	30	M 8	9L8ME	72,40	50	2000
12	39	34	M 10	9L10ME	126,30	50	1500

Blister

ME	Precios		Envase	Embalaje	Embalaje
Ø [mm]	Código	Precio €/Blister	(Uds.)	(Blister)	(Uds.)
8	5L6ME5	5,60	5	10	50
10	5L8ME4	5,60	4	10	40

Cargas recomendadas F_{Rec} [kN]

	Hormigón C20/25	Ladrillo macizo MZ 12	Ladrillo macizo KSV 12	Distancia entre anclajes	Distancia a los bordes	h ₁ [mm]
	F _{Rec} [kN]	F _{Rec} [kN]	F _{Rec} [kN]	S _{Cr} [mm]	C _{Cr} [mm]	
ME 4	0,40	0,30	0,30	60	40	50
ME 6	0,65	0,55	0,55	60	60	60
ME 8	1,10	0,90	0,90	80	80	70
ME 10	1,60	1,30	1,30	80	80	80

F_{Rec}: Los valores de carga incluyen los factores de seguridad.

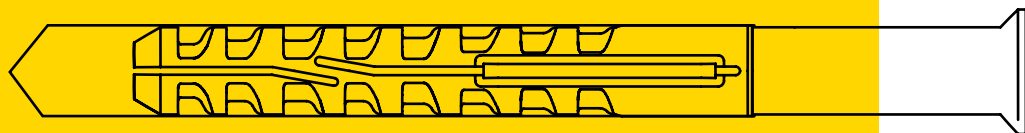

Fijaciones de premarco y tacos largos

Taco multimaterial MFR	44
Taco para hueco HBR	47
Taco de golpe NP	49
Taco de golpe NPZ	51
Taco rastrel BN	52
Tornillo y tapón de fijación de premarcos FBS/FBSZ	53
Taco metálico para premarco MR	54

Taco multimaterial MFR



SB TX, galv. / A4 / HD



SB SSKS, galv. / A4 / HD



FB SSKS, galv. / A4 / HD

Características

- Expansión cuádruple para conseguir mejores valores de extracción.
- Aletas antirotación para evitar el giro.
- Valona en el modelo FB para evitar contacto entre tornillo y perfil.
- Soporta temperaturas entre -40 °C a +80 °C.
- MFR Ø8 empotramiento 50 mm.
- MFR Ø10 empotramiento de 50 mm y 70 mm.
- MFR Ø14 empotramiento de 70 mm.

Adecuado para materiales

- Hormigón
- Ladrillo hueco
- Ladrillo macizo
- Caliza
- Hormigón poroso
- Piedra
- Bloque hueco

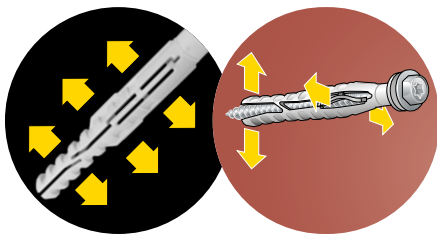

Nuevas aletas antirotación para evitar el giro.

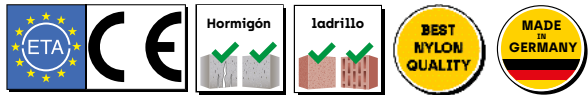

European Technical Assessment for concrete and masonry



see ETA

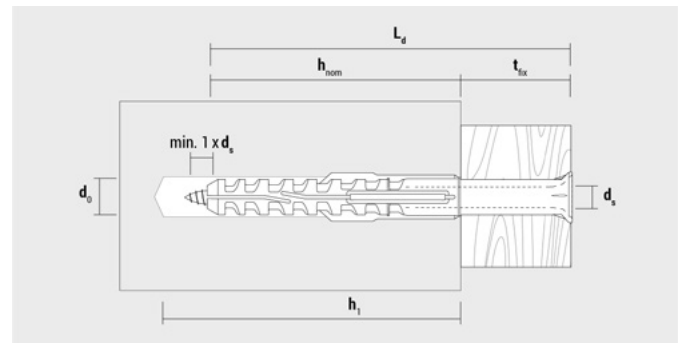

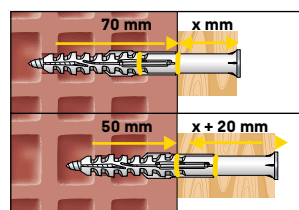
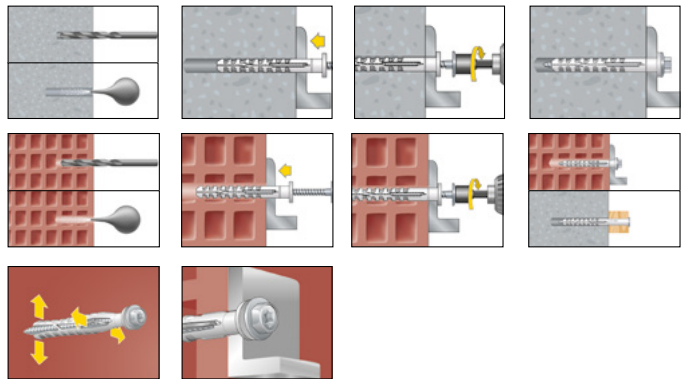

MFR 8: $d_0 = 6$ mm, MFR 10: $d_0 = 7$ mm, MFR 14: $d_0 = 10$ mm

Instalación





MFR 10: Ahora con doble empotramiento.



Cajas

MFR SB TX Cincado						Precios		Envase	Embalaje
Ø [mm]	H ₁ ≥ [mm]	H _{nom} ≥ [mm]	T _{fix} ≥ [mm]	L [mm]	Impr.	Código	Precio €/100 u.	 (Uds.)	 (Uds.)
8	60	50	10	60	TX30	9860MFRST	69,70	100	800
8	60	50	30	80	TX30	9880MFRST	82,30	100	800
8	60	50	50	100	TX30	98100MFRST	95,10	50	400
8	60	50	70	120	TX30	98120MFRST	110,70	50	400
10	60	50	10	60	TX40	91060MFRST	100,30	50	400
10	60/80	50/70	30/10	80	TX 40	91080MFRST	115,50	50	400
10	60/80	50/70	50/30	100	TX 40	910100MFRST	124,00	50	400
10	60/80	50/70	65/45	115	TX 40	910115MFRST	140,90	50	400
10	60/80	50/70	85/65	135	TX 40	910135MFRST	153,40	50	400
10	60/80	50/70	110/90	160	TX 40	910160MFRST	186,00	50	400
10	60/80	50/70	150/130	200	TX 40	910200MFRST50	340,70	50	200
10	60/80	50/70	190/170	240	TX 40	910240MFRST50	418,30	50	200
14	80	70	10	80	TX 50	91480MFRST	214,80	25	200
14	80	70	40	110	TX 50	914110MFRST	294,20	25	200
14	80	70	70	140	TX 50	914140MFRST	387,20	25	200
14	80	70	100	170	TX 50	914170MFRST	495,70	25	200
14	80	70	130	200	TX 50	914200MFRST	542,20	25	200
14	80	70	160	230	TX 50	914230MFRST	604,00	25	200
14	80	70	200	270	TX 50	914270MFRST	810,60	25	200



Con taco avellanado y tornillo cabeza avellanada.

MFR SB TX Inoxidable A4						Precios		Envase	Embalaje
Ø [mm]	H ₁ ≥ [mm]	H _{nom} ≥ [mm]	T _{fix} ≥ [mm]	L [mm]	Impronta	Código	Precio €/100 u.	 (Uds.)	 (Uds.)
8	60	50	30	80	TX 30	9X880MFRST	213,60	100	800
8	60	50	50	100	TX 30	9X8100MFRST	215,80	50	400
10	60	50	10	60	TX 40	9X1060MFRST	375,50	50	400
10	60/80	50/70	30/10	80	TX 40	9X1080MFRST	376,20	50	400
10	60/80	50/70	50/30	100	TX 40	9X10100MFRST	392,60	50	400
10	60/80	50/70	65/45	115	TX 40	9X10115MFRST	449,70	50	400
10	60/80	50/70	85/65	135	TX 40	9X10135MFRST	531,60	50	400
10	60/80	50/70	110/90	160	TX 40	9X10160MFRST	638,00	50	400

Con taco avellanado y tornillo cabeza avellanada.

MFR SB TX Galvanizado en caliente						Precios		Envase	Embalaje
Ø [mm]	H ₁ ≥ [mm]	H _{nom} ≥ [mm]	T _{fix} ≥ [mm]	L [mm]	Impronta	Código	Precio €/100 u.	 (Uds.)	 (Uds.)
10	80	70	30	100	TX 40	9HD10100MFRST	150,10	50	400
10	80	70	65	135	TX 40	9HD10135MFRST	184,50	50	400
10	80	70	90	160	TX 40	9HD10160MFRST	223,10	50	400

Con taco avellanado y tornillo cabeza avellanada.

MFR SB SSKS Cincado						Precios		Envase	Embalaje
Ø [mm]	H ₁ ≥ [mm]	H _{nom} ≥ [mm]	T _{fix} ≥ [mm]	L [mm]	Impronta	Código	Precio €/100 u.	 (Uds.)	 (Uds.)
8	60	50	10	60	SW10/TX 30	9860MFRSB	76,60	100	800
8	60	50	30	80	SW10/TX 30	9880MFRSB	92,20	100	800
8	60	50	50	100	SW10/TX 30	98100MFRSB	110,70	50	400
8	60	50	70	120	SW10/TX 30	98120MFRSB	126,40	50	400
10	60	50	10	60	SW13/TX 40	91060MFRSB	106,60	50	400
10	60/80	50/70	30/10	80	SW13/TX 40	91080MFRSB	118,50	50	400
10	60/80	50/70	50/30	100	SW13/TX 40	910100MFRSB	136,10	50	400
10	60/80	50/70	65/45	115	SW13/TX 40	910115MFRSB	149,30	50	400
10	60/80	50/70	85/65	135	SW13/TX 40	910135MFRSB	186,00	50	400
10	60/80	50/70	110/90	160	SW13/TX 40	910160MFRSB	200,30	50	400
10	60/80	50/70	150/130	200	SW13/TX 40	910200MFRSB50	371,80	50	200
10	60/80	50/70	190/170	240	SW13/TX 40	910240MFRSB50	456,90	50	200
14	80	70	10	80	SW17/TX 50	91480MFRSB	263,30	25	200
14	80	70	40	110	SW17/TX 50	914110MFRSB	317,80	25	200
14	80	70	70	140	SW17/TX 50	914140MFRSB	418,30	25	200
14	80	70	100	170	SW17/TX 50	914170MFRSB	518,80	25	200
14	80	70	130	200	SW17/TX 50	914200MFRSB	580,70	25	200
14	80	70	160	230	SW17/TX 50	914230MFRSB	678,50	25	200
14	80	70	200	270	SW17/TX 50	914270MFRSB	823,10	25	200

Con taco avellanado y tornillo cabeza hexagonal.

Blister

MFR SB TX Cincado		Precios		Envase	Embalaje	Embalaje
Ø [mm]	Código	Precio €/Blister	 (Uds.)	 (Bolsas)	 (Uds.)	
8	5860MFRST4	4,60	4	10	40	
8	5880MFRST4	5,60	4	10	40	
10	51060MFRST4	5,80	4	10	40	
10	51080MFRST4	6,40	4	10	40	
10	510100MFRST4	7,00	4	10	40	
10	510115MFRST4	7,70	4	10	40	
10	510135MFRST4	10,40	4	10	40	
10	510160MFRST4	11,60	4	10	40	

Cajas

MFR SB SSKS Inoxidable A4						Precios		Envase	Embalaje
Ø [mm]	H ₁ ≥ [mm]	H _{nom} ≥ [mm]	T _{fix} ≥ [mm]	L [mm]	Impronta	Código	Precio €/100 u.	(Uds.)	(Uds.)
10	60	50	10	60	SW13/TX 40	9X1060MFRSB	375,50	50	400
10	60/80	50/70	30/10	80	SW13/TX 40	9X1080MFRSB	441,80	50	400
10	60/80	50/70	50/30	100	SW13/TX 40	9X10100MFRSB	531,60	50	400
10	60/80	50/70	65/45	115	SW13/TX 40	9X10115MFRSB	597,00	50	400
10	60/80	50/70	85/65	135	SW13/TX 40	9X10135MFRSB	621,60	50	400
10	60/80	50/70	110/90	160	SW13/TX 40	9X10160MFRSB	744,30	50	400

Con taco avellando y tornillo cabeza hexagonal.

MFR FB SSKS Cincado						Precios		Envase	Embalaje
Ø [mm]	H ₁ ≥ [mm]	H _{nom} ≥ [mm]	T _{fix} ≥ [mm]	L [mm]	Impronta	Código	Precio €/100 u.	(Uds.)	(Uds.)
8	60	50	60	10	SW10/TX30	9860MFRFB	76,60	100	800
8	60	50	80	30	SW10/TX30	9880MFRFB	92,20	100	800
10	60	50	10	60	SW13/TX 40	91060MFRFB	106,60	50	400
10	60/80	50/70	80	30/10	SW13/TX 40	91080MFRFB	118,50	50	400
10	60/80	50/70	100	50/30	SW13/TX 40	910100MFRFB	136,10	50	400
14	80	70	80	10	SW17/TX 50	91480MFRFB	246,10	25	200
14	80	70	110	40	SW17/TX 50	914110MFRFB	317,80	25	200
14	80	70	140	70	SW17/TX 50	914140MFRFB	390,90	25	200

Con taco valona y tornillo cabeza hexagonal.

MFR FB SSKS Inoxidable A4						Precios		Envase	Embalaje
Ø [mm]	H ₁ ≥ [mm]	H _{nom} ≥ [mm]	T _{fix} ≥ [mm]	L [mm]	Impronta	Código	Precio €/100 u.	(Uds.)	(Uds.)
10	60	50	10	60	SW13/TX 40	9X1060MFRFB	375,50	50	400
10	60/80	50/70	30/10	80	SW13/TX 40	9X1080MFRFB	441,80	50	400
10	60/80	50/70	50/30	100	SW13/TX 40	9X10100MFRFB	531,60	50	400

Con taco avellando y tornillo cabeza avellanada.

MFR SB SSKS Galvanizado en caliente						Precios		Envase	Embalaje
Ø [mm]	H ₁ ≥ [mm]	H _{nom} ≥ [mm]	T _{fix} ≥ [mm]	L [mm]	Impronta	Código	Precio €/100 u.	(Uds.)	(Uds.)
10	80	70	100	30	SW13/TX 40	9HD10100MFRSB	163,30	50	400
10	80	70	135	65	SW13/TX 40	9HD10135MFRSB	223,10	50	400
10	80	70	160	90	SW13/TX 40	9HD10160MFRSB	240,50	50	400

Con taco avellando y tornillo cabeza hexagonal.

Blister

MFR FB SSKS Cincado		Precios		Envase	Embalaje	Embalaje
Ø [mm]	Código	Precio €/Blister	(Uds.)	(Bolsas)	(Uds.)	(Uds.)
8	5880MFRFB4	5,80	4	10	40	40
10	51060MFRFB4	5,90	4	10	40	40

Cargas recomendadas F_{Rec} [kN]

Denom.	Hormigón		Ladrillo macizo		Ladrillo macizo silicocalcáreo		Ladrillo hueco	Ladrillo silicocalcáreo hueco	Bloque Hormigón hueco	Hormigón poroso			Losas alveolares prefabricadas pretensadas	Momento flector admisible para tornillos cincados	
	h _{nom}	≥ C16/20	Mz 10	Mz 20	KS 10	KS 20	HLz 12	KSL 12	Hbn 25	AAC2	AAC4	AAC6	C45/55	M _{per} [Nm]	
	[mm]	N _{per} [kN]	V _{per} [kN]	F _{per} [kN]	F _{per} [kN]	F _{per} [kN]	F _{per} [kN]	F _{per} [kN]	F _{per} [kN]	F _{per} [kN]	F _{per} [kN]	F _{per} [kN]	F _{per} [kN]	N _{per} [kN]	M _{per} [Nm]
MFR 8	50	0,99	3,31	0,26	0,43	0,57	0,86	0,14	0,21	0,34	-	-	-	1,39	5,03
MFR 10	50	0,99	4,86	0,71	1,00	0,71	1,14	0,34	0,43	0,71	-	-	-	-	8,74
MFR 10	70	1,59	4,86	0,57	0,86	0,57	0,86	0,21	0,26	0,21	0,14	0,43	0,71	0,48	8,74
MFR 14	70	1,79	8,69	0,86	1,29	0,86	1,29	0,21	0,34	-	0,11	0,43	0,71	-	20,97

F_{rk} o N_{rk} = Cargas de acuerdo con homologación ETA.

F_{per} = Carga admisible con factores de seguridad. Valores son válidos para la media. Rango de temperatura en la pared de máx. + 24 °C (y puntas de 40 °C).

Reducir capacidades de carga con temperatura máxima de 50 °C (puntas de 80 °C)

Distancias entre anclajes y al borde

Tipo	Profundidad de anclaje h _{nom} [mm]	Distancias	Hormigón ≥ C16/20 [mm]	Ladrillo macizo Mz/KS		Ladrillo hueco HLz/ Ladrillo silicocalcáreo hueco KSL		Hormigón poroso								
				Anclaje único [mm]	Anclaje en grupo [mm]	Anclaje único [mm]	Anclaje en grupo [mm]	P2		P4		P6				
								Anclaje único [mm]	Anclaje en grupo [mm]	Anclaje único [mm]	Anclaje en grupo [mm]	Anclaje único [mm]	Anclaje en grupo [mm]			
MFR 8	50	Distancia paralela entre anclajes a / s _{2,min}	50	250	400	250	400	-	-	-	-	-	-	-	-	
MFR 10	50		50	250	400	250	200	-	-	-	-	-	-	-	-	
MFR 10	70		50	250	400	250	400	250	200	250	300	250	400	400	400	
MFR 14	70	Distancia perpendicular entre anclajes a / s _{1,min}	100	250	400	250	480*/400	250	200	250	300	250	400	400	400	
MFR 8	50		50	250	200	250	200	-	-	-	-	-	-	-	-	
MFR 10	50		50	250	200	250	200	-	-	-	-	-	-	-	-	
MFR 10	70		50	250	200	250	200	250	100	250	150	250	200	200	200	
MFR 14	70	Distancia mínima al borde c _{min}	100	250	200	250	240*/200	250	100	250	150	250	200	200	200	
MFR 8	50		60	100	100	100	100	-	-	-	-	-	-	-	-	
MFR 10	50		50	100	100	100	100	-	-	-	-	-	-	-	-	
MFR 10	70		60	100	100	100	100	50	50	75	75	100	100	100	100	
MFR 14	70	Espesor mínimo h _{min}	100	100	100	120*/100	120*/100	50	50	75	75	100	100	100	100	
MFR 8	50		100	Depende del tipo de ladrillo	Depende del tipo de ladrillo	-	-	-	-	-	-	-	-	-	-	
MFR 10	50		100			-	-	-	-	-	-	-	-	-	-	-
MFR 10	70		110			100	100	100	100	100	100	100	100	100	100	100
MFR 14	70	120	100			100	100	100	100	100	100	100	100	100	100	

* Los valores son para HLz

Taco para hueco HBR



FIJACIÓN



Características

- Empotramiento 90 mm
- La guía flexible interior permite que el tornillo se deslice eficazmente.
- Adecuado para fijación pasante de marcos en ladrillo hueco.
- Los valores recomendados de extracción solo se obtienen cuando se utilizan los tornillos homologados.
- Soporta temperaturas entre -40 °C a + 80 °C.
- Se homologa el conjunto taco y tornillo. El taco suelto no está homologado.

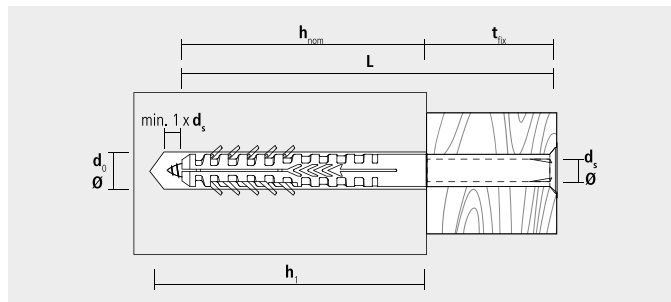

Adecuado para materiales

- Hormigón poroso
- Hormigón ligero
- Ladrillo hueco
- Bloque hueco de hormigón



Instalación

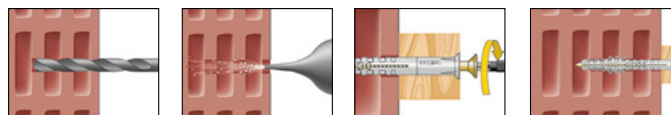

Cajas

HBR Sin tornillo						Precios		Envase	Embalaje
Ø [mm]	h _i ≥ [mm]	h _{nom} ≥ [mm]	L [mm]	t _{fix} ≤ [mm]	d _s [mm]	Código	Precio €/100 u.	(Uds.)	(Uds.)
8*	80	65	80	15	5-6	9880HBR	23,00	50	900
10	100	90	100	10	6-7	910100HBR	37,50	100	800
10	100	90	115	25	6-7	910115HBR	47,20	100	800
10	100	90	135	45	6-7	910135HBR	52,20	50	400
10	100	90	160	70	6-7	910160HBR	94,50	50	400
10	100	90	200	110	6-7	910200HBR	200,00	50	400



* Sin homologación

HBR SP						Precios		Envase	Embalaje
Ø [mm]	h _i ≥ [mm]	h _{nom} ≥ [mm]	L [mm]	t _{fix} ≤ [mm]	d _s [mm]	Código	Precio €/100 u.	(Uds.)	(Uds.)
8	80	65	80	15	5,5	9880HBRSZ	83,90	25	450



Con taco avellanado y tornillo avellanado PZ3.

* Sin homologación



Cajas

HBR SSP						Precios		Envase	Embalaje
\emptyset [mm]	$h_1 \geq$ [mm]	$h_{nom} \geq$ [mm]	L [mm]	$t_{fix} \leq$ [mm]	d_s [mm]	Código	Precio €/100 u.	 (Uds.)	 (Uds.)
10	100	90	100	10	7	910100HBRSZ	108,30	50	400
10	100	90	115	25	7	910115HBRSZ	130,50	50	400
10	100	90	135	45	7	910135HBRSZ	139,20	50	400
10	100	90	160	70	7	910160HBRSZ	179,00	50	400

Con taco avellanado y tornillo avellanado PZ4.

HBR TX						Precios		Envase	Embalaje
\emptyset [mm]	$h_1 \geq$ [mm]	$h_{nom} \geq$ [mm]	L [mm]	$t_{fix} \leq$ [mm]	d_s [mm]	Código	Precio €/100 u.	 (Uds.)	 (Uds.)
10	100	90	100	10	7	910100HBRST	113,00	50	400
10	100	90	115	25	7	910115HBRST	139,20	50	400
10	100	90	135	45	7	910135HBRST	148,10	50	400
10	100	90	160	70	7	910160HBRST	189,80	50	400
10	100	90	200	110	7	910200HBRST	293,10	25	200
10	100	90	240	150	7	910240HBRST	448,40	25	200

Con taco avellanado y tornillo avellanado TX40.

HBR SSK						Precios		Envase	Embalaje
\emptyset [mm]	$h_1 \geq$ [mm]	$h_{nom} \geq$ [mm]	L [mm]	$t_{fix} \leq$ [mm]	d_s [mm]	Código	Precio €/100 u.	 (Uds.)	 (Uds.)
10	100	90	100	10	7	910100HBRSB	117,20	50	400
10	100	90	115	25	7	910115HBRSB	138,90	50	400
10	100	90	135	45	7	910135HBRSB	152,30	50	400
10	100	90	160	70	7	910160HBRSB	193,80	50	400
10	100	90	200	110	7	910200HBRSB	362,20	25	200
10	100	90	240	150	7	910240HBRSB	404,80	25	200

Con taco avellanado y tornillo hexagonal SW13/ TX40.

Cargas recomendadas F_{Rec} [kN]									
Denom.	Ladrillo hueco HLZ 12		Arenisca calcárea \geq KSL 12		Bloque de hormigón Hbl2		Ladrillo macizo silicoalcaláreo KS 12		Momento flector permitido
	F_{Rk} [kN]	F_{Per} [kN]	F_{Rk} [kN]	F_{Per} [kN]	F_{Rk} [kN]	F_{Per} [kN]	F_{Rk} [kN]	F_{Per} [kN]	[Nm]
HBR 8	0,40	-	0,50	-	0,37	-	1,30	-	4,5
HBR 10	-	0,34	-	0,21	-	0,11	-	0,86	13,0

F_{Rec} : Cargas recomendadas con factores de seguridad incluidos y basada en test internos

F_{Per} : Cargas de acuerdo con homologación ETA con factores de seguridad incluidos.

Distancias	Ladrillo hueco HLZ		Arenisca calcárea KSL		Bloque de hormigón Hbl		Ladrillo macizo silicoalcaláreo KS	
	Anclaje único [mm]	Anclaje en grupo [mm]	Anclaje único [mm]	Anclaje en grupo [mm]	Anclaje único [mm]	Anclaje en grupo [mm]	Anclaje único [mm]	Anclaje en grupo [mm]
	Distancia paralela entre anclajes S/S2, min	250	320	250	360	250	250	250
Distancia perpendicular entre anclajes S/S2, min.	250	160	250	180	250	100	250	200
Distancia mínima al borde C_{min}	80	-	80	-	50	-	100	-
Espesor mínimo material base h_{min}	175	175	175	175	240	240	175	175

Taco de golpe NP



NPC con valona avellanada



NP con valona plana



NPM con valona avellanada tornillo con cabeza métrica

Características

- Refuerzo en la cabeza del taco para impedir ser atravesado.
- Tirafondo robusto PZ.
- Optimización entre taco y clavo para dar valores de sujeción elevados.
- Soporta temperaturas entre -40 °C a +80 °C.

Adecuado para materiales

- Hormigón
- Piedra
- Ladrillo macizo
- Ladrillo hueco
- Bloque hueco

Caja

NPC Con valona avellanada						Precios		Envase	Embalaje
Ø [mm]	h ₁ ≥ [mm]	h _{nom} ≥ [mm]	L _d [mm]	t _{fix} ≤ [mm]	Impronta PZ	Código	Precio €/100 u.	(Uds.)	(Uds.)
5	35	25	35	10	2	9535NPC	10,50	100	1800
5	35	25	50	25	2	9550NPC	14,00	100	1800
6	40	30	35	5	2	9635NPC	11,00	100	1800
6	40	30	40	10	2	9640NPC	12,10	100	1800
6	40	30	50	20	2	9650NPC	14,00	50	900
6	40	30	60	30	2	9660NPC	15,00	50	900
6	40	30	80	50	2	9680NPC	24,90	50	900
8	50	40	60	20	2	9860NP	26,00	50	600
8	50	40	80	40	2	9880NP	33,20	50	600
8	50	40	100	60	2	98100NP	36,90	50	600
8	50	40	120	80	2	98120NP	48,70	50	400
8	50	40	135	95	2	98135NP	55,80	50	400

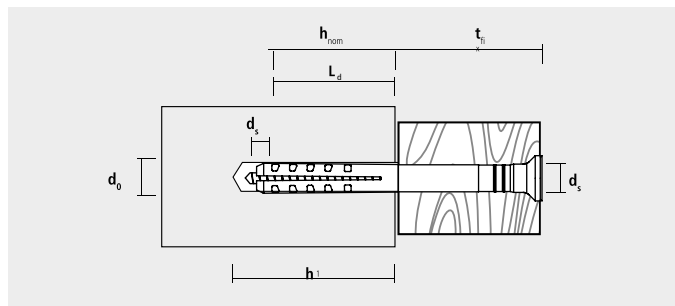

Instalación

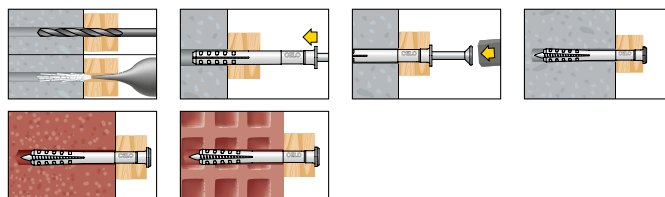



Blister

NPC	Precios		Envase	Embalaje	Embalaje
	Ø [mm]	Código	Precio €/Blister	(Uds.)	(Blister) (Uds.)
8	5860NP10	6,90	10	10	100
8	5880NP10	6,90	10	10	100
8	58100NP10	6,90	10	10	100
8	58120NP5	6,90	5	10	50
8	58135NP5	6,90	5	10	50



Cajas

NP Con valona plana							Precios		Envase	Embalaje
Ø [mm]	h ₁ ≥ [mm]	h _{nom} ≥ [mm]	L [mm]	t _{fix} ≤ [mm]	Impronta PZ	Código	Precio €/100 u.	 (Uds.)	 (Uds.)	
4	25	20	25	2	2	9425RT ^A	13,90	100	4000	
5	25	23	25	2	2	9525NP	13,80	200	3600	
5	35	25	35	10	2	9535NP	13,30	100	1800	
5	35	25	50	25	2	9550NP	13,80	100	1800	
6	40	30	35	5	2	9635NP	11,00	100	1800	
6	40	30	40	10	2	9640NP	12,10	100	1800	
6	40	30	50	20	2	9650NP	14,00	50	900	
6	40	30	60	30	2	9660NP	15,00	50	900	
6	40	30	70	40	2	9670NP	17,80	50	600	
6	40	30	80	50	2	9680NP	24,90	50	900	



A: Nylon transparente y tornillo cincado especial canaletas.

NP Con valona plana inoxidable A2							Precios		Envase	Embalaje
Ø [mm]	h ₁ ≥ [mm]	h _{nom} ≥ [mm]	L [mm]	t _{fix} ≤ [mm]	d _s [mm]	Impronta PZ	Código	Precio €/100 u.	 (Uds.)	 (Uds.)
5	35	25	35	10	4	2	9X535RT	37,50	100	1800
6	40	30	40	10	4	2	9X640RT	48,00	100	1800
8	50	40	70	30	5	2	9X870RT	81,00	100	900

Con tornillo inoxidable A2.

NPM Con tornillo métrico					Precios		Envase	Embalaje
Ø [mm]	h ₁ ≥ [mm]	t _{fix} ≤ [mm]	L [mm]	Rosca	Código	Precio €/100 u.	 (Uds.)	 (Uds.)
6	40	10	40	M6	9640NPM6	36,10	100	1.800
8	40	15	45	M8	9845NPM8	52,30	50	900

Con cabeza métrica.

NP Con valona plana inoxidable A2							Precios		Envase	Embalaje
Ø [mm]	h ₁ ≥ [mm]	h _{nom} ≥ [mm]	L [mm]	t _{fix} ≤ [mm]	Impronta PZ	Código	Precio €/100 u.	 (Uds.)	 (Uds.)	
5	35	25	35	10	2	9X535NP	34,40	100	1800	
5	35	25	50	25	2	9X550NP	36,30	100	1800	
6	40	30	40	10	2	9X640NP	41,50	100	1800	
6	40	30	60	30	2	9X660NP	45,40	50	900	
6	40	30	80	50	2	9X680NP	53,10	50	900	

Con tornillo inoxidable A2.



Cargas recomendadas F_{Rec} [kN]

Denom.	Hormigón C20/25		Piedra Caliza Maciza KS12		Hormigón Poroso P2		Hormigón Poroso P4		Ladrillo hueco HLZ 12	
	F _{RK} (kN)	F _{Per} [kN]	F _{RK} (kN)	F _{Per} [kN]	F _{RK} (kN)	F _{Per} [kN]	F _{RK} (kN)	F _{Per} [kN]	F _{RK} (kN)	F _{Per} [kN]
NP 5	0,20	1,40	0,17	1,20	0,05	0,35	0,09	0,63	0,08	0,56
NP 6	0,21	1,50	0,19	1,33	0,06	0,42	0,10	0,70	0,09	0,63
NP 8	0,29	2,00	0,26	1,80	0,09	0,63	0,13	0,91	0,10	0,70

F_{Rec}: Cargas recomendadas con factores de seguridad incluidos y basada en test internos.

F_{Per}: Cargas de acuerdo con homologación ETA con factores de seguridad incluidos.

Blister

NP	Precios		Envase	Embalaje	Embalaje
Ø [mm]	Código	Precio €/Blister	 (Uds.)	 (Bolsas)	 (Uds.)
5	5535NP20	6,90	20	10	200
5	5550NP20	6,90	20	10	200
6	5640NP15	6,90	15	10	150
6	5660NP15	6,90	15	10	150
6	5680NP10	6,90	10	10	100

Taco de golpe NPZ



Características

- Taco de zamak y clavo de acero.
- Cabeza ancha.
- Indesmontable (antirrobo).

Adecuado para materiales

- Hormigón
- Piedra natural
- Ladrillo macizo
- Calcáreo-Ladrillo macizo
- Piedra pómez

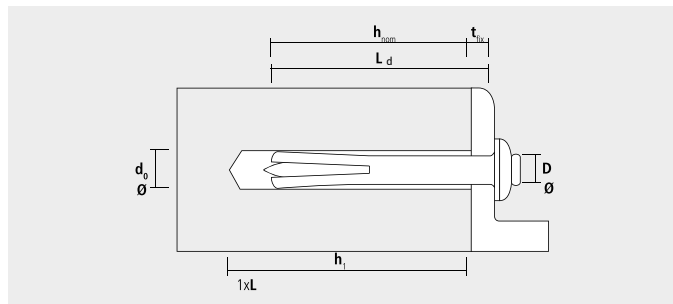

Instalación

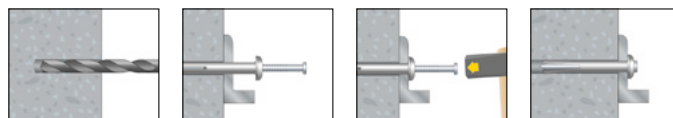

Cajas

NPZ						Precios		Envase	Embalaje
\emptyset [mm]	$h_i \geq$ [mm]	$h_{nom} \geq$ [mm]	L_d [mm]	$t_{fa} \leq$ [mm]	D [mm]	Código	Precio €/100 u.	(Uds.)	(Uds.)
5	22	15	22	7	10,50	9522NPZ	22,70	100	4800
5	25	20	40	20	10,50	9540NPZ	31,60	100	3000
6	25	20	40	20	12,60	9640NPZ	42,20	100	2000

Cargas recomendadas F_{Rec} [kN]		Hormigón C20/25 F_{Rec} [kN]
NPZ 5-22		0,60
NPZ 5-40		0,75
NPZ 6-40		1,00

F_{Rec} : Cargas recomendadas con factor de seguridad 3.

Taco rastrel BN



Características

- Taco metálico para fijaciones ligeras.
- Instalación rápida con martillo.
- Diseñado para la fijación pasante de listones.
- Fabricado en acero galvanizado de alta calidad.

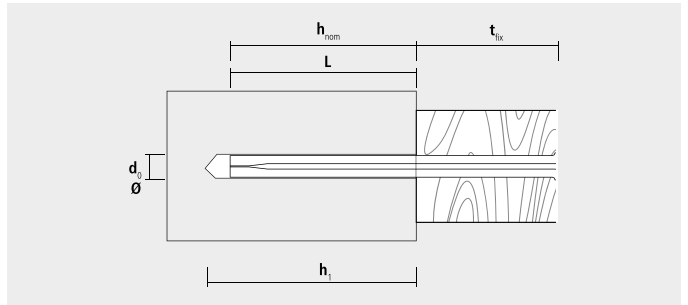

Adecuado para materiales

- Hormigón
- Piedra natural
- Ladrillo macizo
- Bloque hormigón

Instalación

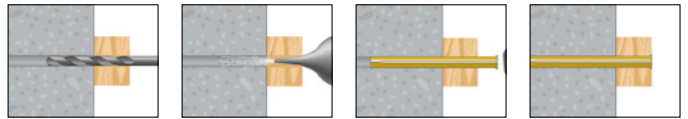

Cajas

BN					Precios		Envase	Embalaje
Ø [mm]	h _i ≥ [mm]	h _{nom} ≥ [mm]	L [mm]	t _{fix} ≤ [mm]	Código	Precio €/100 u.	(Uds.)	(Uds.)
6	40	30	60	30	9B660BN	23,30	100	1200
6	40	30	80	50	9B680BN	28,00	100	1200
8	50	40	90	50	9B890BN	48,10	50	1100
8	50	40	110	70	9B8110BN	59,40	50	600
8	50	40	130	90	9B8130BN	69,10	50	600

Cargas recomendadas F_{Rec} [kN]

Ø [mm]	Hormigón C20/25	
	F _{RK} [kN]	F _{PER} [kN]
BN 6	0,8	2,5
BN 8	1,1	3,3

F_{RK}: Cargas recomendadas con factor de seguridad incluido (μ=3)

F_{PER}: Cargas sin factor de seguridad

Tornillo y tapón de fijación de premarcos **FBS / FBSZ**

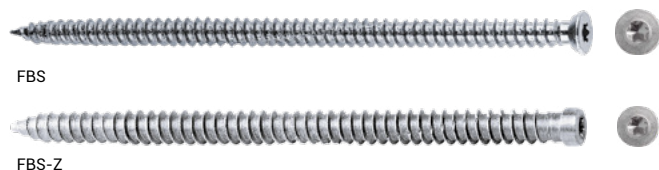

FBS

FBS-Z

Características

- Impronta TX30.
- Cincados y lubricados.
- Pueden incorporar tapones.
- Requiere taladro previo Ø6 (madera Ø5 mm).
- Ambas referencias con estrías debajo la cabeza.

Adecuado para materiales

- Hormigón
- Piedra natural
- Ladrillo macizo
- Madera
- Hormigón ligero
- Ladrillo hueco
- Bloque sólido

Cajas

FBS					Precios		Envase	Embalaje
Ø Tornillo [mm]	d ₀ [mm]	*d _i [mm]	L [mm]	h ₁ ≥ [mm]	Código	Precio €/100 u.	Uds.	Uds.
7,5	6	6,2	62	depende del material de construcción, h _{nom} + 10 mm	97562FBS	27,50	100	600
7,5	6	6,2	72		97572FBS	34,10	100	600
7,5	6	6,2	92		97592FBS	50,00	100	600
7,5	6	6,2	112		975112FBS	59,20	100	600
7,5	6	6,2	132		975132FBS	78,90	100	600
7,5	6	6,2	152		975152FBS	92,10	100	600
7,5	6	6,2	182		975182FBS	128,80	100	400

Con tornillo fijación directa con cabeza avellanada.
*d_i, mm: Ø Agujero en el marco.

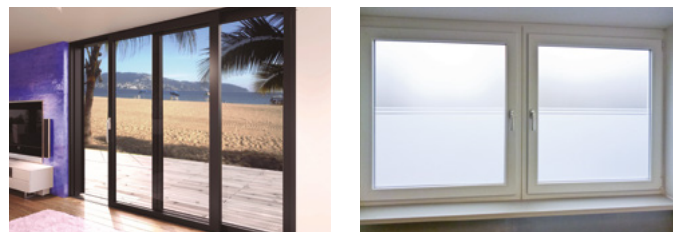

FIJACIÓN

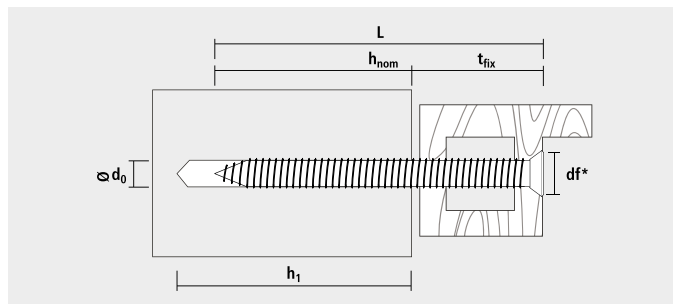

Instalación

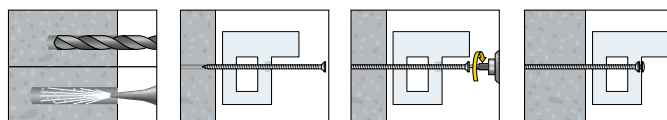

FBSZ					Precios		Envase	Embalaje
Ø Tornillo [mm]	d ₀ [mm]	*d _i [mm]	L [mm]	h ₁ ≥ [mm]	Código	Precio €/100 u.	Uds.	Uds.
8	6	6	72	depende del material de construcción, h _{nom} + 10 mm	97572FBSZ	34,10	100	600
8	6	6	92		97592FBSZ	50,00	100	600
8	6	6	112		975112FBSZ	59,20	100	600

Con tornillo fijación directa con cabeza cilíndrica.
*d_i, mm: Ø Agujero en el marco.
(1) En materiales huecos.

Profundidad anclaje h_{nom}

Hormigón [mm]	Ladrillo macizo [mm]	Piedra [mm]	Ladrillo hueco [mm]	Madera [mm]
≥ 30	≥ 40	≥ 40	≥ 60 mínimo 2 paredes	≥ 50



AKF



AKF TX30

Cajas

AKF	Precios		Envase
Color	Código	Precio €/100 u.	Uds.
Negro	94AKF	7,20	100
Marrón oscuro	9MAKF	7,20	100
Blanco	91AKF	7,20	100

AKF TX30	Precios		Envase
Color	Código	Precio €/100 u.	Uds.
Marrón oscuro	9MAKFTX30	7,20	100
Marrón claro	9HAKFTX30	7,20	100
Blanco	91AKFTX30	7,20	100

Taco metálico para premarco MR



Características

- Elevada resistencia a la cizalladura.
- Impronta PZ3.
- Camisa con baño de lámina de zinc que proporciona una buena resistencia a la corrosión.

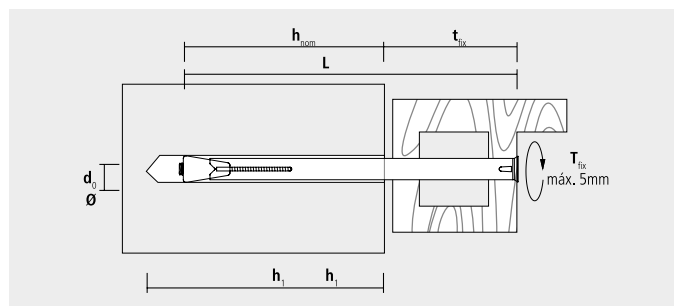

Adecuado para materiales

- Hormigón
- Bloque hormigón
- Bloque macizo
- Ladrillo hueco
- Ladrillo macizo

Instalación

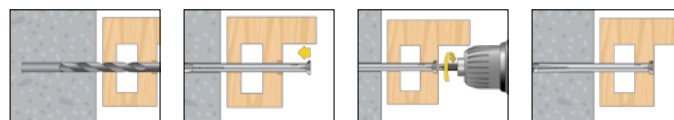

Cajas

MR					Precios		Envase	Embalaje
Ø [mm]	h _{1z} [mm]	h _{nomz} [mm]	L [mm]	t _{fix} ≤ [mm]	Código	Precio €/100 u.	(Uds.)	(Uds.)
10	50	30	72	42	91072MR	65,20	100	600
10	50	30	92	62	91092MR	74,20	100	400
10	50	30	112	82	910112MR	78,00	100	400
10	50	30	132	102	910132MR	89,20	100	400
10	50	30	152	122	910152MR	93,70	100	400
10	50	30	182	152	910182MR	129,30	100	400

Cargas recomendadas F_{Rec} [kN]

Denom.	Hormigón C20/25	Ladrillo macizo MZ 12	Bloque macizo KS 12	Ladrillo hueco KSL 6	Bloque caliza V12
	F _{Eff} [kN]	F _{Eff} [kN]	F _{Eff} [kN]	F _{Eff} [kN]	F _{Eff} [kN]
MR 10	1,35	1,25	1,25	0,50	0,45

F_{Eff}: Cargas recomendadas con factor de seguridad incluido (μ=4)

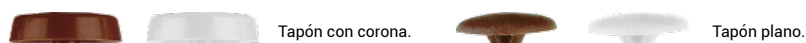

Cajas

UK Tapón con corona	Precios		Envase
Color	Código	Precio €/100 u.	(Uds.)
Blanco	91UK	7,20	100
Marrón oscuro	9MUK	7,20	100

AKMR Tapón plano	Precios		Envase
Color	Código	Precio €/100 u.	(Uds.)
Blanco	91AKMR	7,20	100
Marrón oscuro	9MAKMR	7,20	100

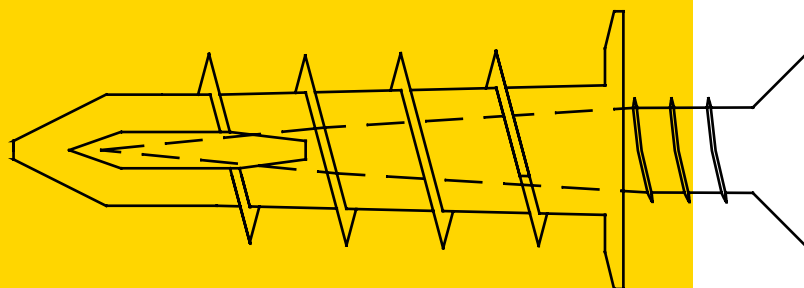

Fijaciones placa de yeso y hueco

Basculante multiuso BT	56
Basculante BE, BG, BS	57
Taco metálico para hueco HRM - MZA 100	58
Taco de nylon para hueco HR	59
Taco para cartón yeso GKD / GKDZ	60
Taco autotaladrante TPL	61

Basculante multiuso BT

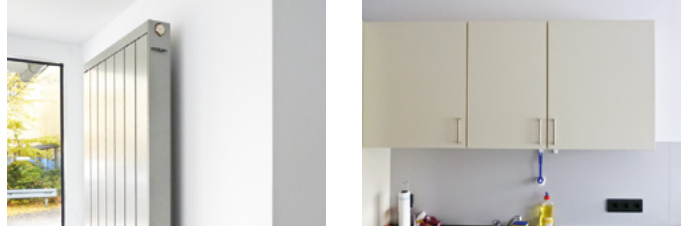
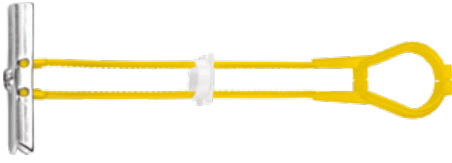

Características

- Taco para cavidades.
- Rápido y universal.
- No necesitan herramientas de aplicación.
- Altos valores de carga.
- Para placas de entre 10-70 mm de espesor.

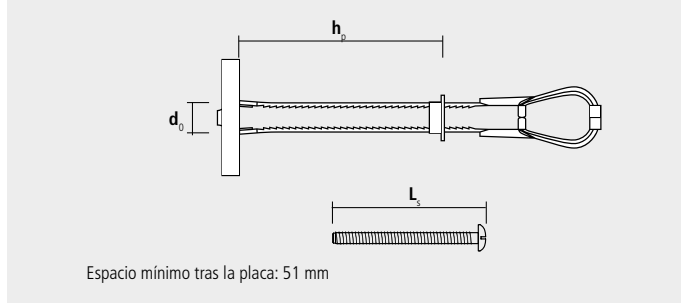

Adecuado para materiales

- Cartón yeso
- Tableros
- Bloques huecos

Instalación

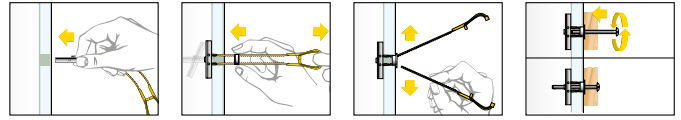

Cajas

BT Sin tornillo			Precios		Envase	Embalaje
Ø [mm]	h _p [mm]	d ₀ [mm]	Código	Precio €/100 u.	(Uds.)	(Uds.)
M 4	10 - 70	13	9Y4BTP	107,50	40	320
M 5	10 - 70	13	9Y5BTP	107,50	30	240
M 6	10 - 70	13	9Y6BTP	107,50	30	240
M 8	10 - 70	18 - 19	9Y8BTP	144,40	20	160

Blisters

BT Con tornillo					Precios		Envase	Embalaje
Ø [mm]	h _p [mm]	d ₀ [mm]	L ₃ [mm]	Impronta	Código	Precio €/100 u.	(Uds.)	(Uds.)
M 4	10 - 70	13	50	PZ2 / ranura	9Y4BTPL0	134,60	40	320
M 5	10 - 70	13	62	PZ2 / ranura	9Y5BTPL0	137,80	30	240
M 6	10 - 70	13	62	PZ2 / ranura	9Y6BTPL0	141,20	30	240
M 8	10 - 70	18 - 19	60	Hexagonal	9Y8BTPK	174,00	20	160

BT	Precios		Envase	Embalaje	Embalaje
d ₀ [mm]	Código	Precio €/Blister	(Uds.)	(Blister)	(Uds.)
13	54BTLO4	6,30	4	10	40
13	55BTLO4	6,50	4	10	40
13	56BTLO4	7,00	4	10	40

Cargas recomendadas F_{rec} [kN]

Ø [mm]	d ₀ [mm]	N _{rec} : Resistencia a la tracción en cartón yeso				V _{rec} : Resistencia a la cizalladura en cartón yeso			
		hp = 9,5 mm [kN]	hp = 12,5 mm [kN]	hp = 2x9,5 mm [kN]	hp = 2x12,5 mm [kN]	hp = 9,5 mm [kN]	hp = 12,5 mm [kN]	hp = 2x9,5 mm [kN]	hp = 2x12,5 mm [kN]
BT M4	13	0,07	0,15	0,15	0,30	0,20	0,20	0,25	0,30
BT M5	13	0,20	0,25	0,40	0,50	0,30	0,30	0,50	0,50
BT M6	13	0,20	0,25	0,40	0,50	0,30	0,30	0,50	0,50
BT M8	19	0,20	0,25	0,40	0,50	0,30	0,40	0,50	0,50

Basculante BE , BG, BS

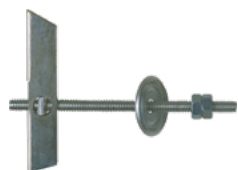

Basculante espárrago BE



Basculante gancho BG



Basculante suelto BS



FIJACIÓN

Instalación

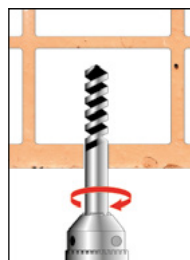

Taladrar.

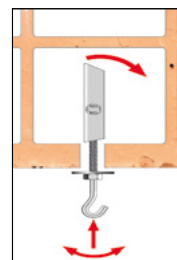

Introducir y bascular.

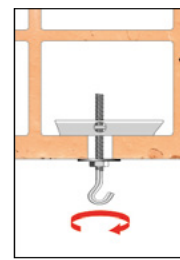

Fijar.

Características

- Fijación de carga ligera en falsos techos y bovedillas.
- Acero cincado.
- Tuerca rosca métrica.

Cajas

BE			Precios		Envase	Embalaje
Ø [mm]	Rosca	Profund. Mín Cavidad [mm]	Código	Precio €/100 u.	(Uds.)	(Uds.)
11	M4	55	9532BE	32,70	100	900
14	M5	70	9316BE	74,70	50	450
16	M6	80	914BE	106,90	50	450

BG			Precios		Envase	Embalaje
Ø [mm]	Rosca	Profund. Mín Cavidad [mm]	Código	Precio €/100 u.	(Uds.)	(Uds.)
11	M4	55	9532BG	68,70	100	900
14	M5	70	9316BG	82,80	50	450
16	M6	80	914BG	125,80	50	450

BS			Precios		Envase	Embalaje
Ø [mm]	Rosca	Profund. Mín Cavidad [mm]	Código	Precio €/100 u.	(Uds.)	(Uds.)
17	M6	80	96BS	62,70	100	900
23	M8	90	98BS	135,40	50	450

Taco metálico para hueco

HRM - MZA 100



HRM



MZA 100



Características

- Adecuado para cartón yeso y tableros.

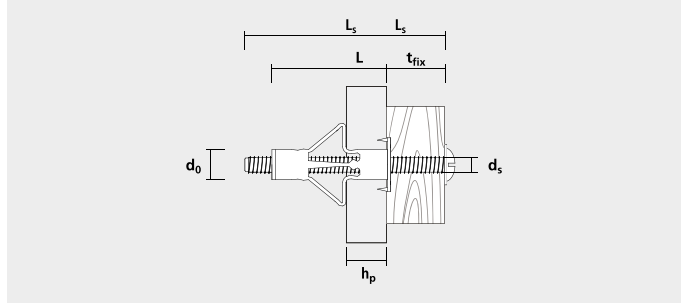

Cajas

HRM					Precios		Envase	Embalaje
Ø [mm]	h _p [mm] Min-máx	d _s [mm]	L _s [mm]	L [mm]	Código	Precio €/100 u.	(Uds.)	(Uds.)
8	3 - 18	M 4	52	46	9420HRM50	48,60	50	1350
8	18 - 24	M 4	58	52	9424HRM50	51,70	50	1350
8	32 - 38	M 4	72	66	9438HRM50	53,50	50	1350
11	3 - 16	M 5	58	52	9516HRM50	67,20	50	1350
11	14 - 32	M 5	71	65	9532HRM25	76,00	25	675
11	32 - 45	M 5	88	80	9545HRM25	88,00	25	675
13	3 - 16	M 6	58	52	9616HRM25	74,10	25	675
13	14 - 32	M 6	71	65	9632HRM25	90,30	25	675
13	32 - 45	M 6	88	80	9645HRM25	96,70	25	675
13	3 - 16	M 8	61	53	9816HRM25*	107,40	25	675
13	16 - 32	M 8	73	66	9832HRM20*	115,10	20	540

* Tornillo hexagonal SW13.

Instalación HRM con pinza

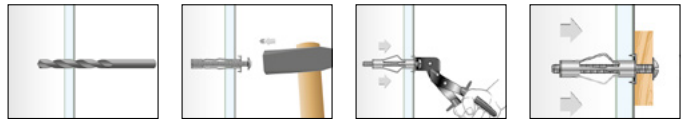

Instalación HRM sin pinza

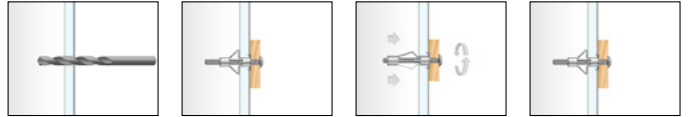

MZA 100 Para HRM	Precios		Envase	Embalaje
Denom.	Código	Precio €/u.	(Uds.)	(Uds.)
MZA 100	9MZA00	31,10	1	-

Cargas recomendadas F_{Rec} [kN]

Denom.	Listón de madera	Tableros	Cartón yeso			
	h _p = 6 mm F _{Rec} [kN]	h _p = 16 mm F _{Rec} [kN]	h _p = 9,5 mm F _{Rec} [kN]	h _p = 12,5 mm F _{Rec} [kN]	h _p ≥ 2 x 12,5 mm F _{Rec} [kN]	h _p ≥ 2 x 12,5 mm F _{Rec} [kN]
HRM 4-20	0,15	0,25	0,15	0,15	-	-
HRM 4-24	-	-	-	-	0,15	-
HRM 4-38	-	-	-	-	-	0,25
HRM 5-16	0,20	0,25	0,20	0,20	-	-
HRM 5-32	-	-	-	-	0,35	-
HRM 5-45	-	-	-	-	-	0,35
HRM 6-16	0,25	0,30	0,25	0,25	-	-
HRM 6-32	-	-	-	-	0,35	-
HRM 6-45	-	-	-	-	-	0,40
HRM 8-16	0,30	0,40	0,25	0,25	-	-
HRM 8-32	-	-	-	-	0,40	-

F_{Eff}: Cargas recomendadas con factor de seguridad incluido (μ=3)

Taco de nylon para hueco HR



FIJACIÓN

Características

- Adecuado para fijaciones en cartón yeso y tableros.
- Para instalación de cargas ligeras.
- Instalación con tornillos rosca madera.

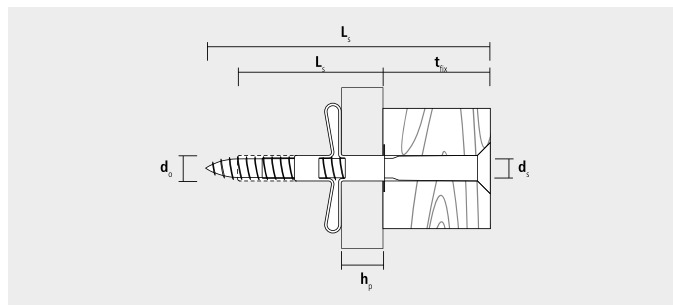

Adecuado para materiales

- Cartón yeso
- Tableros

Instalación

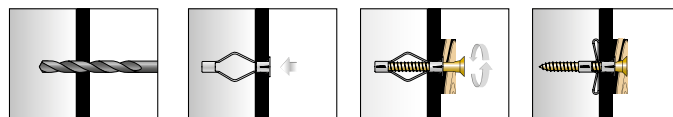

Cajas

HR				Precios		Envase	Embalaje
Ø [mm]	h _p Min-max [mm]	d _s [mm]	L [mm]	Código	Precio €/100 u.	(Uds.)	(Uds.)
6	3-14	3,5	30	9630HR	10,70	100	4800
8	10-16	4	40	9840HR	11,90	50	2400

Cargas recomendadas F _{Rec} [kN]				
	Tableros contrachapado	Tableros aglomerado	Cartón yeso	
	hp = 6 mm F _{Rec} [kN]	hp = 16 mm F _{Rec} [kN]	h _p = 9,5 mm F _{Rec} [kN]	h _p = 12,5 mm F _{Rec} [kN]
HR 6-30	0,10	-	0,08	0,08
HR 8-40	-	0,15	-	0,10

F_{Eff}: Cargas recomendadas con factor de seguridad incluido (μ=3)

Taco para cartón yeso

GKD / GKDZ

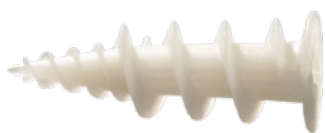

GKD NYLON



GKD ZAMAK



Características

- Rápido: un solo paso, sin taladro previo.
- Compatible con tornillo rosca madera y rosca aglomerado.
- GKDZ permite montaje de tornillo M4.

Adecuado para materiales

- Cartón yeso

Cajas

GKD				Precios		Envase	Embalaje
L [mm]	h _p máx. [mm]	d _s min - máx. [mm]	L _s [mm]	Código	Precio €/100 u.	(Uds.)	(Uds.)
35	9-12,5	3 - 4,5	22 + t _{fix}	9GKD	22,90	50	2400

GKD Con tornillo PZ				Precios		Envase	Embalaje
L [mm]	h _p máx. [mm]	d _s min - máx. [mm]	L _s [mm]	Código	Precio €/100 u.	(Uds.)	(Uds.)
35	9-12,5	4,0x40	18	9GKDPZ	35,40	50	2400

Con tornillo PZ.

GKDZ				Precios		Envase	Embalaje
L [mm]	h _p máx. [mm]	d _s min - máx. [mm]	L _s [mm]	Código	Precio €/100 u.	(Uds.)	(Uds.)
37	9	4,5	19 + t _{fix}	937GKDZ	26,90	100	2700
37	9	4,5	19 + t _{fix}	937GKDZ50	33,40	50	2400

GKDZ Con tornillo PZ				Precios		Envase	Embalaje
L [mm]	h _p máx. [mm]	h _s min - máx. [mm]	L _s [mm]	Código	Precio €/100 u.	(Uds.)	(Uds.)
37	9	4,5 x 35	16	937GKDZPZ50	45,60	50	2400

Cargas recomendadas F_{Rec} [kN]

	Cartón yeso		
	h _p = 9,5 mm F _{Rec} [kN]	h _p = 12,5 mm F _{Rec} [kN]	h _s ≥ 2 x 12,5 mm F _{Rec} [kN]
GKD	0,07	0,07	-
GKDZ	0,08	0,08	0,16

F_{Rec}: Cargas recomendadas con factor de seguridad incluido (μ=4)

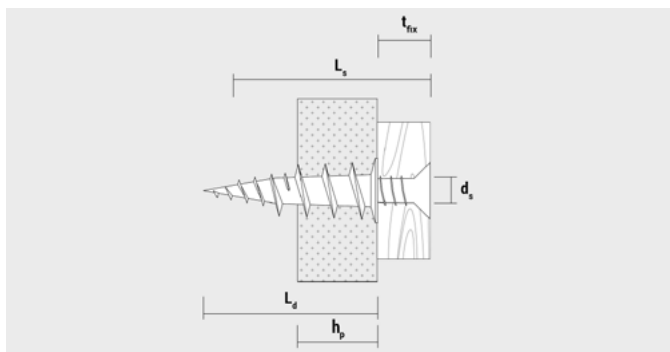
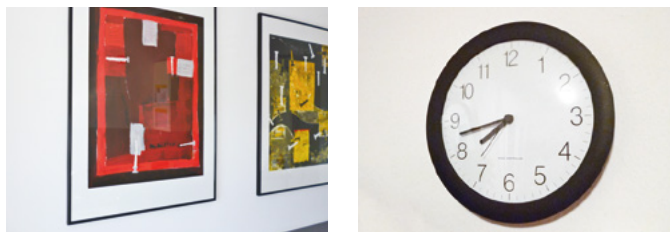

Instalación

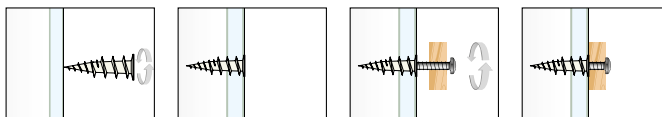

GKD NYLON

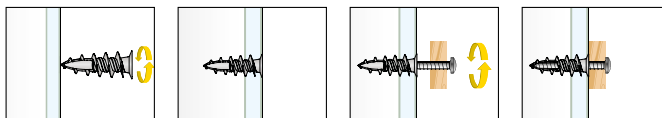

GKD ZAMAK

Blisters

GKD	Precios		Envase	Embalaje	Embalaje
L [mm]	Código	Precio €/Blister	(Uds.)	(Blister)	(Uds.)
35	5GKD10	5,20	10	10	100

GKD Con tornillo PZ	Precios		Envase	Embalaje	Embalaje
L [mm]	Código	Precio €/Blister	(Uds.)	(Blister)	(Uds.)
35	5GKDPZ6	5,20	6	10	100

GKDZ	Precios		Envase	Embalaje	Embalaje
L [mm]	Código	Precio €/Blister	(Uds.)	(Blister)	(Uds.)
37	537GKDZS6	5,20	10	10	60

Taco autotaladrante TPL

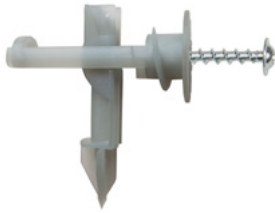

FIJACIÓN

Características

- Rápido: sin taladro previo.
- Fijación autotaladrante de basculación.
- No necesita accesorios: se instala con una punta PZ2 o PZ3.
- Tornillo incluido: 3,7x50.
- Para fijar pletinas de hasta 15 mm con el tornillo incluido.
- Para pletinas más gruesas, cambiar el tornillo por otro tornillo más largo.
- Para placas de cartón yeso de hasta 15 mm de espesor.

Adecuado para materiales

- Cartón yeso

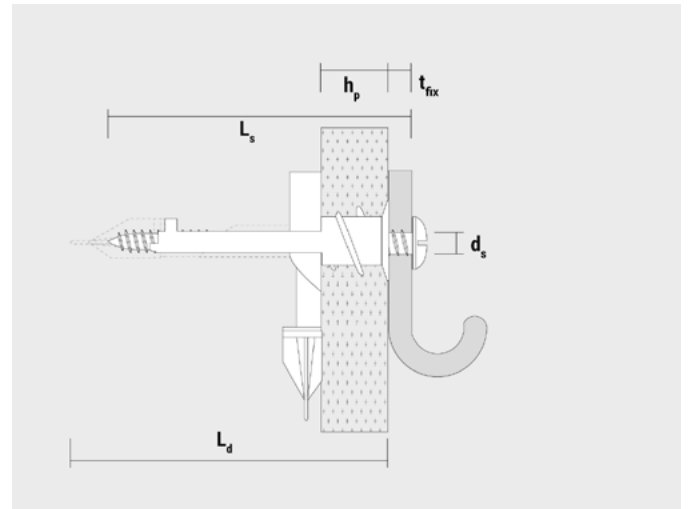

Instalación

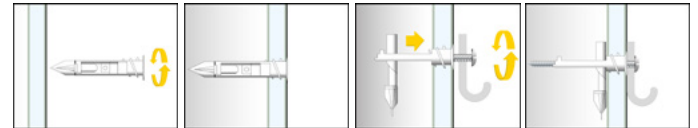

Cajas

TPL Con tornillo 3,7x50, impronta de taco: PH2 / PZ2					Precios		Envase	Embalaje
L _d [mm]	h _p ≥ [mm]	d _s [mm]	L _s [mm]	t _{fixw} [mm]	Código	Precio €/100 u.	(Uds.)	(Uds.)
54	48	3,7	50	15	9TPLZ	126,80	50	900

Cargas recomendadas

Resistencia ⁽¹⁾	Espesor placa [mm]	
	12,5	15
Resistencia tracción Kg	12	20
Resistencia cortante Kg	30	44

(1) F_{Rec}: Cargas recomendadas con factor de seguridad incluido (μ=4).

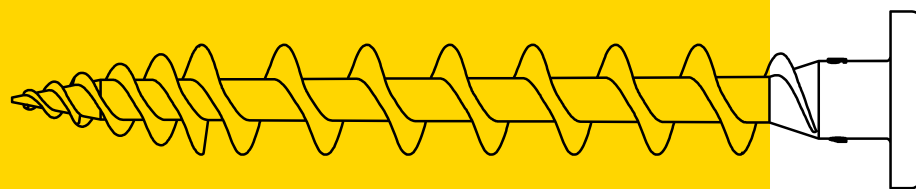

Fijaciones para aislamientos

Fijación de aislamiento IPD	64
Tacos para fijar sobre aislamientos IPL	65
Tacos para fijar sobre aislamientos IPL 95DS	66
Tornillo para fijar sobre aislamiento IPS 80	67

Fijación de aislamiento IPD



IPD 8 Clavo metálico



IPD 10 Clavo de fibra de vidrio



Características

- Mayor resistencia al expansionar el taco.
- El diseño del soporte permite una gran resistencia al impacto y evita que se doble cuando se fija sobre el material base.
- Fijación de materiales aislantes a pared.

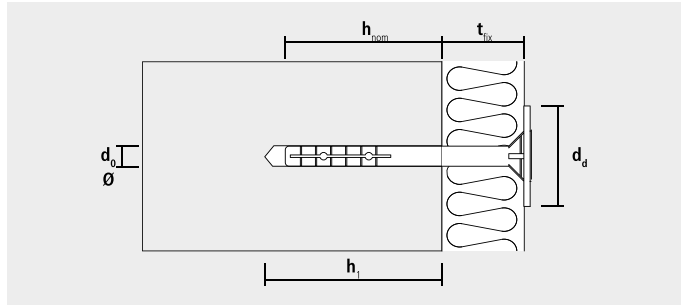

Adecuado para materiales

- Hormigón
- Piedra natural
- Ladrillo macizo
- Bloque de hormigón
- Hormigón poroso
- Ladrillo hueco

Instalación

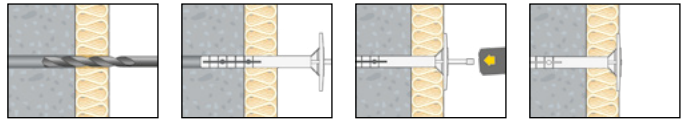

Cajas

IPD 8 Con clavo metálico						Precios		Envase	Embalaje
Ø [mm]	h ₁ ≥ [mm]	h _{nom} ≥ [mm]	L [mm]	d _d [mm]	t _{tr} ≥ [mm]	Código	Precio €/100 u.	(Uds.)	(Uds.)
8	35	25	95	60	70	9895IPD	48,30	200	-
8	35	25	115	60	90	98115IPD	52,60	200	-
8	35	25	135	60	110	98135IPD	55,70	200	-
8	35	25	155	60	130	98155IPD	59,10	200	-
8	35	25	175	60	150	98175IPD	61,80	200	-

IPD 10 Con clavo de fibra de vidrio						Precios		Envase	Embalaje
Ø [mm]	h ₁ ≥ [mm]	h _{nom} ≥ [mm]	L [mm]	d _d [mm]	t _{tr} ≥ [mm]	Código	Precio €/100 u.	(Uds.)	(Uds.)
10	40	30	70	60	40	91070IPD200	37,60	200	-
10	40	30	90	60	60	91090IPD200	39,30	200	-
10	40	30	120	60	90	910120IPD200	41,30	200	-
10	40	30	140	60	110	910140IPD200	53,90	200	-
10	40	30	160	60	130	910160IPD200	57,00	200	-
10	40	30	180	60	150	910180IPD200	65,70	200	-
10	40	30	200	60	170	910200IPD200	78,90	200	-

Cargas recomendadas F _{Per} [kN]	Hormigón C12/15 F _{Per} [kN]	Hormigón ≥ C20/25 F _{Per} [kN]	Ladrillo macizo F _{Per} [kN]	Bloque Hormigón F _{Per} [kN]	Hormigón Poroso P2 F _{Per} [kN]	Ladrillo Hueco F _{Per} [kN]
IPD 8	0,18	0,27	0,27	0,27	0,27	0,21
IPD 10	0,18	0,27	0,27	0,27	0,18	0,21

F_{Per}: Cargas según homologación ETA con factores de seguridad incluidos.

Tacos para fijar sobre aislamientos IPL



IPL 60



IPL 95

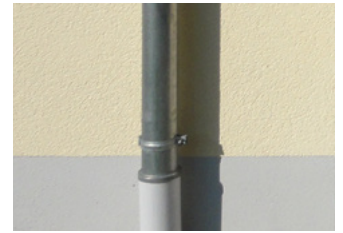

FIJACIÓN

Características

- Taco para fijar sobre aislantes externos, no rompe el aislamiento.
- Fijación directa al aislante.
- Autotaladrante.
- Taco de nylon resistente a la intemperie.
- Permite fijar elementos sobre las placas de aislamiento (desagües, buzones, alarmas, etc..)

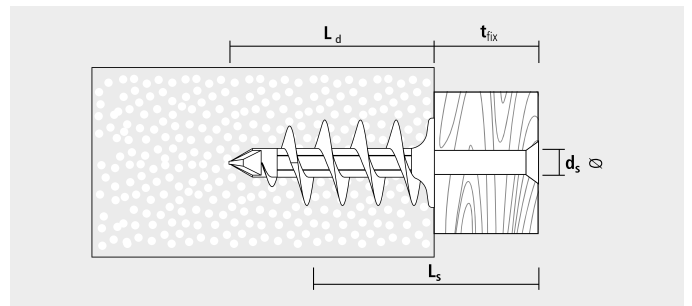

Adecuado para materiales

- Sistema de aislamientos térmicos exterior (SATE).
- Placas de fibra de madera (pretaladro Ø13 mm).
- Placas PU alta densidad
- Placas PS

Instalación

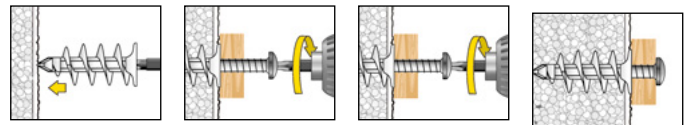

Cajas

IPL					Precios		Envase	Embalaje
Denom.	L _d [mm]	Punta Atornillar	d _s [mm]	L _s [mm]	Código	Precio €/100 u.	(Uds.)	(Uds.)
IPL 60	58	TX 40	4,5 - 5,0	30 + t _{fix}	960IPL	103,50	25	300
IPL 95	95	SW 13	8/10/M8	40 + t _{fix}	995IPL	159,30	25	200

DUO BIT TX20 / TX40		Precios		Envase	Embalaje	Embalaje
Medidas	Usar con	Código	Precio €/100 u.	(Uds.)	(Blister)	(Uds.)
1/4" x 43 mm	IPL60 y TX20	7DTX20TX40	5,80	2	10	20
1/4" x 43 mm	IPL60 y PZ2	7DPZ2TX40	5,80	2	10	20

Cargas recomendadas F _{Per} [kN]					
	Aplicaciones en PS15, PS20 F _{Rec} [kN]	XPS F _{Rec} [kN]	Usar con	Profundidad de inserción del tornillo	
				min. [mm]	max. [mm]
IPL60	0,07	0,14	Tornillo aglomerado Ø 4,5 – 5,0 Espárrago doble rosca Ø 8, Ø 10 y M8	30	50
IPL95	0,14	0,28		40	80

Taco para fijar sobre aislamiento IPL 95DS



IPL 95DS



Características

- La solución perfecta para la sujeción de tubos de desagüe en SATE. Rápida, fácil, flexible y ajustable.
- Instalación directa en el material aislante, evita el puente térmico.
- Espárrago roscado especial premontado, mantiene la distancia ideal (30mm) entre pared y tubo. Se puede ajustar hasta 25 mm manualmente.
- Arandela de caucho premontada y resistente a la intemperie.
- Autotaladrante (placas de aislamiento ≤ 7 mm) taco nylon resistente al envejecimiento.
- Espárrago roscado de acero inoxidable A2 para una resistencia óptima a la corrosión ó recubrimiento orgánico.

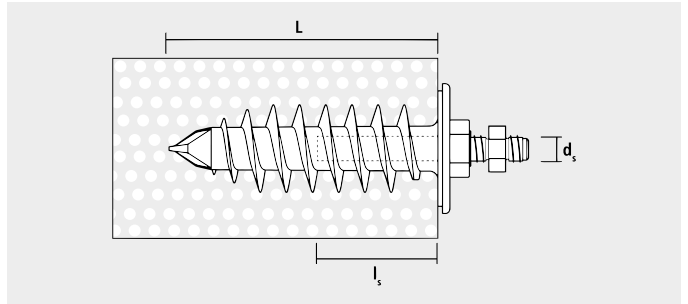

Adecuado para materiales

- Sistema de aislamientos térmicos exterior (SATE).
- Placas de fibra de madera (pretaladro $\varnothing 13$ mm).
- Placas PU alta densidad
- Placas PS

Instalación

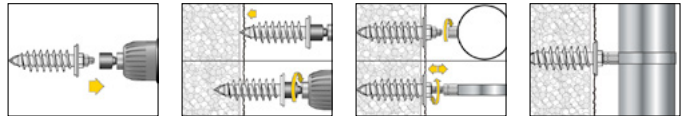

Cajas

IPL 95DS Con arandela de $\varnothing=44,5$ mm y con espárrago.					Precios		Envase	Embalaje
Denom.	L [mm]	Punta atornillar	d_s [mm]	Material	Código	Precio €/100 u.	(Uds.)	(Uds.)
IPL 95DS	95	SW17	M10	Láminas Zn-Al	ZG95IPLDS4	659,60	4	80
IPL 95DS A2	95	Espárrago SW13/TX25	M10	Acero inox. A2	X95IPLDS4	854,50	4	80

Pack de 4 unidades con instrucción en la bolsa.

IPL 95D Con arandela de $\varnothing=44,5$ mm y sin espárrago.				Precios		Envase	Embalaje
Denom.	L [mm]	Rosca interior d_s	Punta atornillar	Código	Precio €/100 u.	(Uds.)	(Uds.)
IPL 95D	95	M10	SW17	995IPLD	553,40	20	160

Cargas recomendadas F_{rec} [kN]					
	Aplicación en EPS (PS15, PS20) F_{rec} [kN]	Aplicación en XPS F_{rec} [kN]	Espárrago especial	Profundidad de inserción L_s	
				mín. [mm]	máx. [mm]
IPL 95DS	0,14	0,28	Longitud total 60 mm Rosca interior del taco: 50 mm	20	50

Tornillo para fijar sobre aislamiento IPS 80

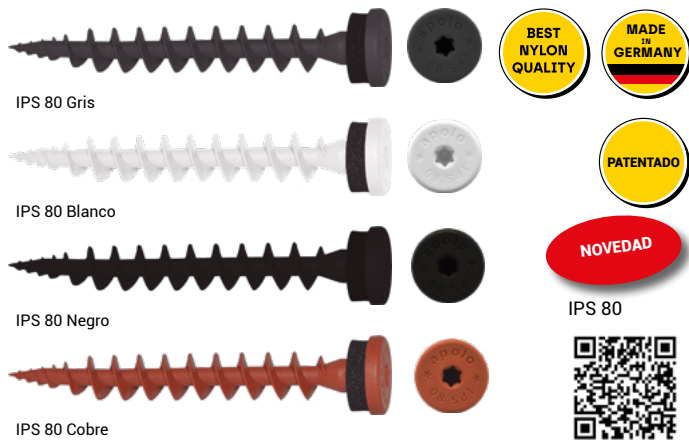

FIJACIÓN

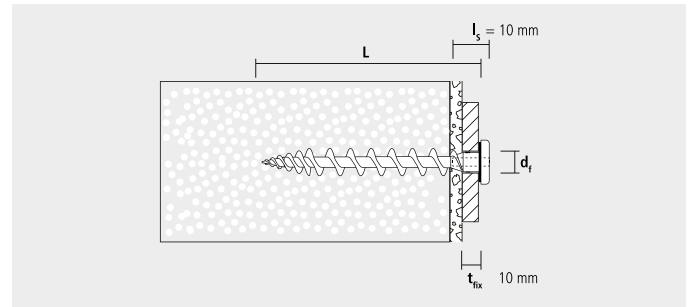

Características

- Tornillo especial para la fijación directa en un sistema de aislamiento térmico el exterior (SATE). Extremadamente rápido y romper sin puente térmico.
- Para la fijación de perfiles de conexión de techo, perfiles de protección de base, cornisas, detectores de movimiento, lámparas, paneles, etc.
- Sin taladro previo (≤ 7 mm) gracias al diseño de la punta rosca-da.
- Tornillo especial de nylon reforzado en fibra de vidrio con goma de EPDM. Resistente al envejecimiento, a la intemperie y a los rayos UV.
- Se adapta a los agujeros previamente perforados $\geq \varnothing 8$ mm (común en los perfiles de pared).
- Adecuado para fijaciones ligeras en combinación con un tornillo de 3,5 mm de diámetro.

Montaje del IPS 80 (perfiles de conexión a pared)

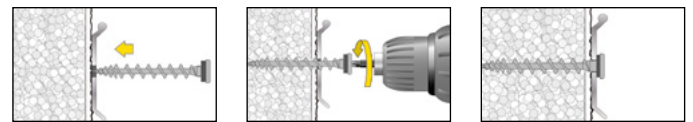

Montaje del IPS 80 (fijaciones ligeras)

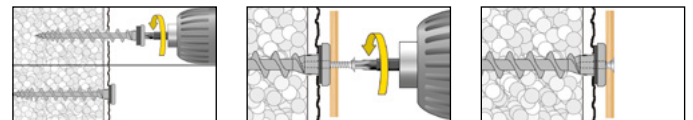

Se puede utilizar con: tornillo $\varnothing 3$ mm; longitud del tornillo $L_s = 10$ mm + espesor del elemento de fijación

Adecuado para materiales

- EPS
- XPS
- Lana de roca
- Paneles de fibra de madera

Cajas

IPS 80				Precios		Envase	Embalaje
Color	L [mm]	Impronta	d _s [mm]	Código	Precio €/100 u.	(Uds.)	(Uds.)
RAL 7045	80	TX 25	8 - 10	9GR80IPS	97,90	50	900
RAL 9003	80	TX 25	8 - 10	9180IPS	97,90	50	900
RAL 9017	80	TX 25	8 - 10	9480IPS	97,90	50	900
RAL 8004	80	TX 25	8 - 10	9C080IPS	97,90	50	900

Con goma EPDM, diámetro de la cabeza $\varnothing = 16,0$ mm

Cargas recomendadas y dimensiones F _{Rec} [kN]					
Denom.	Aplicación en poliestireno EPS (PS15, PS20) sin revocar. F _{Rec} [kN]	Aplicación en poliestireno EPS (PS15, PS20) con revocado. F _{Rec} [kN]	Aplicación en lana de roca, Coverrock Plus sin revocar. F _{Rec} [kN]	Aplicación en poliestireno XPS. F _{Rec} [kN]	Espesor mínimo del material aislante [mm]
IPS80	0,04	0,06 *	0,02	0,09 *	80

F_{Rec}: Carga recomendada en todas direcciones incluyendo un factor de seguridad de 5.
* El valor puede variar en función del tipo de espesor de la placa.

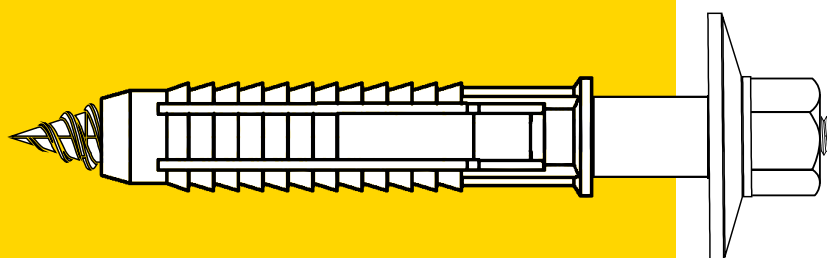

Fijaciones sanitarias y soporte radiador

Fijación vertical WC/FWC	70
Fijación vertical Inox WC/FWC	70
Fijación horizontal WC/FWCH	71
Fijación Cisterna FCIS	71
Fijación horizontal WC/FRH	72
Fijación Lavabo FLTN-H	73
Fijación Termo TA	74
Fijación Calentador TT	75
Fijación Radiador SRR	76
Fijación Radiador SRP	76

Fijación vertical WC/FWC



Características

- Con taco FX que puede utilizarse en casi cualquier material de construcción.
- Para la fijación de WC vertical.
- Tornillo con baño orgánico (protección 7 veces mayor que un cincado tradicional) y tuerca inoxidable que asegura una buena resistencia a la corrosión.
- Casquillo de plástico que protege la cerámica.
- Tuerca ciega M5 Inox A2.

Cajas

WC FWC				Precios		Envase	Embalaje	Embalaje
Ø [mm]	h ₁ ≥ [mm]	L [mm]	t _{fix} [mm]	Código	Precio €/bolsa	📱 (Uds.)	📦 (Bolsas)	📦 (Uds.)
8	50	40	20	580FWC100	2,20	2	100	200
8	50	40	20	580FWC30*	2,90	2	30	60

Componentes del kit: 2 tacos FX8, 2 tornillos doble rosca M5x70, 2 casquillos nylon y 2 tuercas M5 inox ciegas.

* Formato venta cruzada en 3 tiras de 10 bolsas cada una.

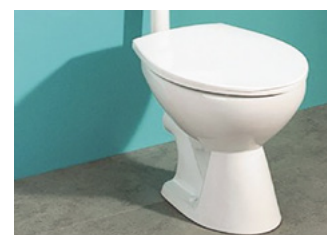

Instalación

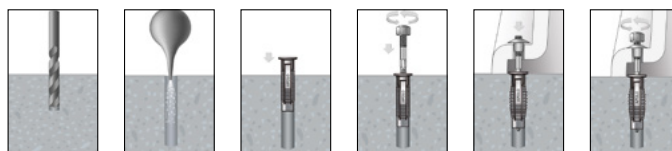

Fijación vertical Inox WC/FWC

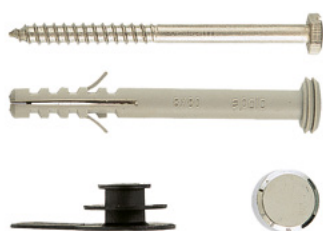

Características

- Utilizable para sanitarios con orificios inclinados, taladrando a través del sanitario.
- Adecuado para instalar sobre hormigón, ladrillo macizo, piedra y ladrillo poroso.

Cajas

WC FWC _{Inox}				Precios		Envase	Embalaje	Embalaje
Ø mm	h ₁ ≥ mm	L mm	t _{fix} mm	Código	Precio €/bolsa	📱 (Uds.)	📦 (Bolsas)	📦 (Uds.)
8	50	80	40	X675FWC100	4,90	2	100	200
8	50	80	40	X675FWC30*	5,50	2	30	60

Componentes del kit: 1 cono centrador, 2 tapones embellecedores, 2 tornillos acero inox Ø6 x 75 y 2 tacos poliamida 8 x 80.

* Formato venta cruzada en 3 tiras de 10 bolsas cada una.

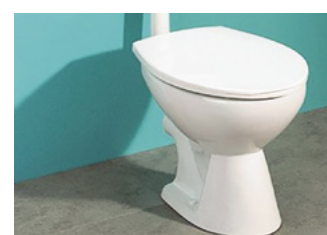

Instalación

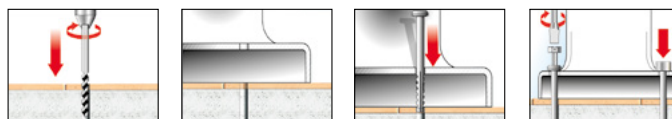

Taladrar.

Situar el sanitario

Introducir el taco

Atornillar y colocar el tapón embellecedor

Fijación horizontal WC/FWCH



FIJACIÓN

Características

- Con taco FX que puede utilizarse en casi cualquier material de construcción.
- Tornillo lateral M6x30 inoxidable A2 que garantiza una buena resistencia a la corrosión.
- Incluye tapones de protección de la cerámica y del espárrago.
- Para la fijación de WC con fijación horizontal.

Instalación

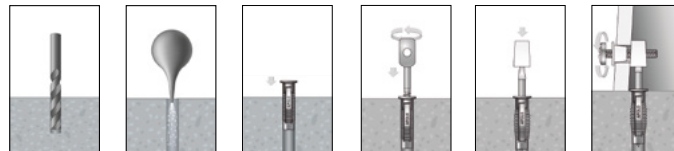

Cajas

WC FWCH				Precios		Envase	Embalaje	Embalaje
Ø [mm]	h ₁ ≥ [mm]	L [mm]	t _{fix} [mm]	Código	Precio €/bolsa	(Uds.)	(Bolsas)	(Uds.)
8	50	40	20	FWCH100	4,50	2	100	200
8	50	40	20	FWCH30*	5,10	2	30	60

Componentes del kit: 2 tacos FX8, 2 tornillos laterales M6x30 Inox. 2 casquillos nylon, 2 tornillos doble rosca especial y 2 capuchones para el tornillo doble rosca especial.
* Formato venta cruzada en 3 tiras de 10 bolsas cada una.

Fijación Cisterna FCIS



Características

- Arandelas sobredimensionadas para evitar fugas.
- Componentes metálicos inoxidables.
- Para la unión entre taza y cisterna.

Instalación

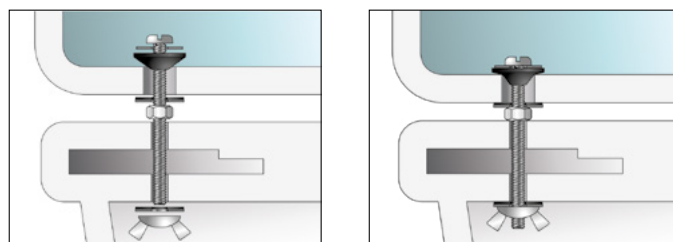

Cajas

FCIS		Precios		Envase	Embalaje	Embalaje
Tornillo	Código	Precio €/bolsa		(Uds.)	(Bolsas)	(Uds.)
M6X90	FCIS100	8,00		2	100	200
M6X90	FCIS30*	9,90		2	30	60

Componentes del kit: 2 tornillos DIN 85 M6x90 inox. , 2 arandelas Ø6, 2 tuercas DIN 934 M6 INOX, 2 DIN 315 M6 INOX, 2 arandelas EPDM y 2 conos EPDM.
* Formato venta cruzada en 3 tiras de 10 bolsas cada una.

Fijación horizontal WC/ FRH



Características

Fácil y rápida instalación:

- Angular con batería de agujeros con autocentrado para una rápida inserción del tornillo.
- Tornillo de fijación con PZ para la inserción y centrado + SW para el apriete + Arandela estampada para una mejor fijación.
- Protector de cerámica con nervios de centrado.
- Embellecedor con clipado rápido y resistente, no necesita regulación y protege la cerámica.

Alta resistencia:

- Taco FX Ø8.

Resistencia a la corrosión:

- Tornillo lateral inoxidable A2.
- Tornillo de fijación con baño orgánico (protección 7 veces mayor que un cincado tradicional).
- Embellecedor cromado de alta resistencia a todo tipo de productos de limpieza.

Sistema patentado:

- Fijación de inodoros con agujeros laterales.

Instalación

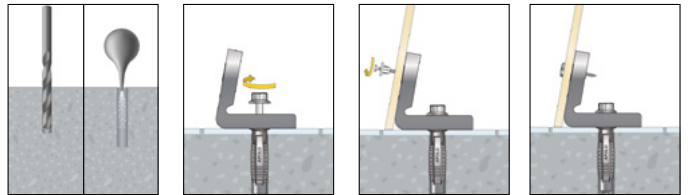
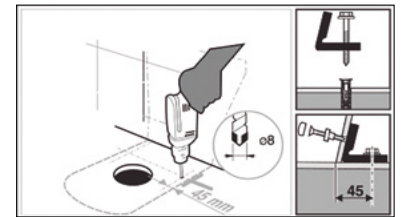
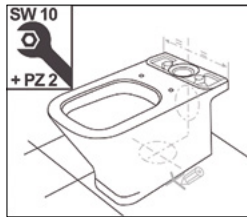

Cajas

FRH		Precios		Envase	Embalaje	Embalaje
Ø [mm]	h ₁ [mm]	Código	Precio €/ bolsa	(Uds.)	(Bolsas)	(Uds.)
8	50	FRH100	7,30	2	100	200
8	50	FRH30*	8,00	2	30	60

Componentes del kit: 2 angulares, 2 tornillos hexagonales 6x60, 2 tornillos 5x45, 2 tacos FX Ø8, 2 embellecedores cromados y 2 protectores de la cerámica.

* Formato venta cruzada en 3 tiras de 10 bolsas cada una.

Fijación Lavabo FLTN-H



Tuerca de nylon



Tuerca de hierro



Características

- Con taco FX que puede utilizarse en casi cualquier material de construcción.
- La arandela de plástico protege la cerámica.
- Para la fijación mural de lavabos.

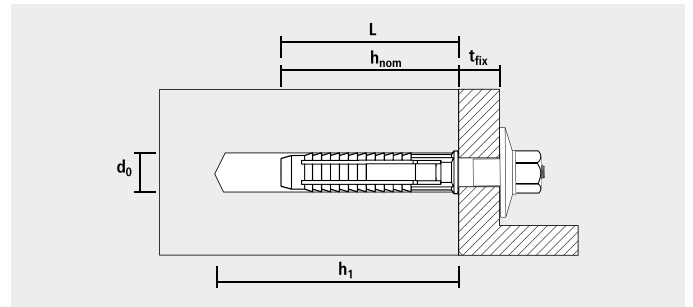

Instalación

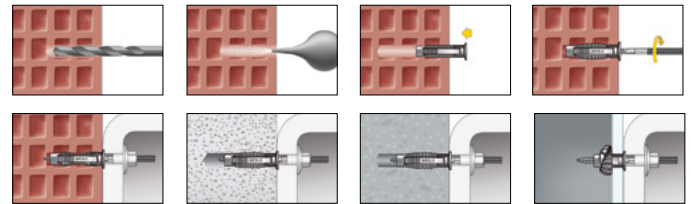

Cajas

FLTN				Precios		Envase	Embalaje	Embalaje
\varnothing [mm]	$h_1 \geq$ [mm]	L [mm]	t_{fix} [mm]	Código	Precio €/bolsa	(Uds.)	(Bolsas)	(Uds.)
10	70	60	20	8100FLTN100	3,50	2	100	200
10	70	60	20	8100FLTN30*	4,20	2	30	60
12	80	20	40	10120FLTN100	4,20	2	100	200
12	80	20	40	10120FLTN30*	4,60	2	30	60

Componentes del kit: 2 tacos FX10/12, 2 espárragos doble rosca M8x100 y M10x120 y 2 tuercas nylon M8/M10.
 * Formato venta cruzada en 3 tiras de 10 bolsas cada una.

FLTH				Precios		Envase	Embalaje	Embalaje
\varnothing [mm]	$h_1 \geq$ [mm]	L [mm]	t_{fix} [mm]	Código	Precio €/bolsa	(Uds.)	(Bolsas)	(Uds.)
10	70	60	20	8100FLTH100	2,60	2	100	200
10	70	60	20	8100FLTH30*	3,20	2	30	60
12	80	70	40	10120FLTH100	3,20	2	100	200
12	80	70	40	10120FLTH30*	3,80	2	30	60

Componentes del kit: 2 tacos FX10/12, 2 espárragos doble rosca M8x100 y M10x120, 2 tuercas nylon M8/M10, 2 tuercas DIN934 M8/M10 y arandelas $\varnothing 8 / \varnothing 10$.
 * Formato venta cruzada en 3 tiras de 10 bolsas cada una.

Fijación Termo TA

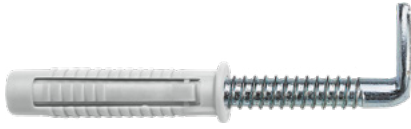

Características

- Con taco FX que puede utilizarse en hormigón, piedra, ladrillo macizo y hueco.
- Apto para la fijación de termos y calentadores.
- Alcayata con cabeza plana para facilitar el montaje del termo.

Instalación

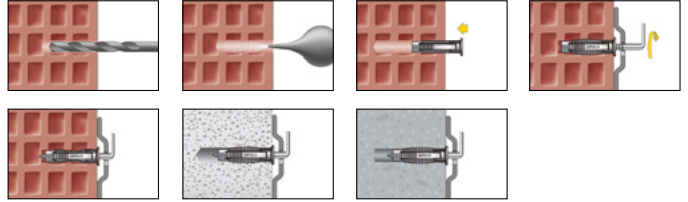

Cajas

TA				Precios		Envase	Embalaje	Embalaje
Ø [mm]	h _z [mm]	L [mm]	t _{fix} [mm]	Código	Precio €/bolsa	📱 (Uds.)	📦 (Bolsas)	📦 (Uds.)
10	60	50	10	865TA100	2,90	2	100	200
10	60	50	10	865TA30*	3,60	2	30	60
12	80	70	10	1075TA100	3,30	2	100	200
12	80	70	10	1075TA30*	4,00	2	30	60

1 Composición del kit: 2 tacos Ø10 y 2 alcayatas Ø8 x 65

2 Composición del kit: 2 tacos Ø12, 2 alcayatas Ø10 x 75

* Formato venta cruzada en 3 tiras de 10 bolsas cada una.

Fijación Calentador TT



FIJACIÓN

Características

- Con Taco FX que puede utilizarse en casi cualquier material de construcción.
- Apto para la fijación de calentadores, radiadores, perfiles metálicos...

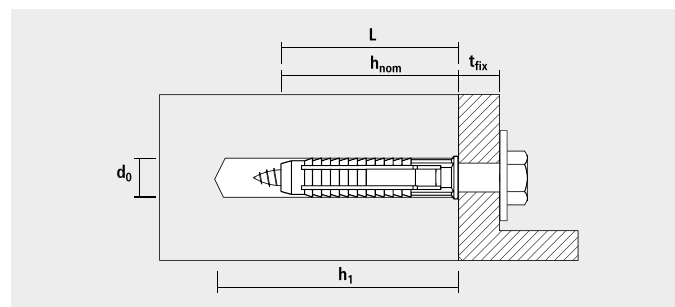

Cajas

TT				Precios		Envase	Embalaje	Embalaje
Ø [mm]	h ₁ ≥ [mm]	L [mm]	t _{fix} [mm]	Código	Precio €/bolsa	📦 (Uds.)	📦 (Bolsas)	📦 (Uds.)
8	50	40	5	645TT100	1,40	2	100	200
8	50	40	5	645TT30*	2,00	2	30	60
10	60	50	10	870TT100	1,90	2	100	200
10	60	50	10	870TT30*	2,50	2	30	60

1 Componentes del kit: 2 tacos FX8, 2 DIN 571 Ø 6x45, 2 arandelas DIN 9021 Ø6
 2 Componentes del kit: 2 tacos FX10, 2 DIN 571 Ø 8x70, 2 arandelas DIN 9021 Ø8
 * Formato venta cruzada en 3 tiras de 10 bolsas cada una.

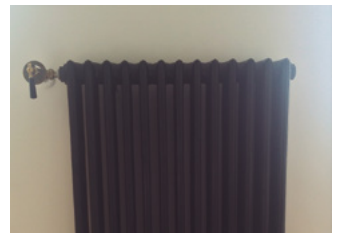
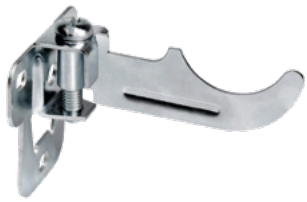

Fijación Radiador SRR



Características

- Regulable.
- Gran resistencia.
- Rapidez y facilidad de montaje.
- Bolsa compuesta por:
 - 2 Soportes
 - 6 Tornillos 5 x 45
 - 6 Tacos Nylon Ø 8

Cajas

SRR		Precios		Envase	Embalaje	Embalaje
Distancia A [mm]	Tipo Radiador	Código	Precio €/bolsa	 (Uds.)	 (Bolsas)	 (Uds.)
75	Aluminio	75ASRR	6,20	2	50	100



Fijación Radiador SRP



Características

- Soporte para radiadores de aluminio.
- Se suministra un conjunto completo por radiador, compuesto por :
 - 2 Soportes
 - 4 Tornigrap Nº 45 5,5 x 45
 - 4 Tacos Nylon Ø 8

Cajas

SRP	Precios		Envase	Embalaje	Embalaje
Tipo Radiador	Código	Precio €/bolsa	 (Uds.)	 (Bolsas)	 (Uds.)
75AL	75ASRP	3,60	2	50	100



Anclajes metálicos

Taco clavo expansor para techo DA	78
Anclaje tornillo directo a hormigón BTS 5	79
Anclaje tornillo directo a hormigón BTS 6	80
Accesorios BTS 6	81
Anclaje tornillo directo a hormigón BTS 8/10/14	82
Anclaje metálico antigiro DT/DV/DA/DG	84
Taco hembra cono expansor SAPK/SAP/ ESW	86
Anclaje espárrago BA plus	88
Anclaje espárrago BAZ	89
Anclaje reforzado SLA	91

Taco clavo expansor para techo DA

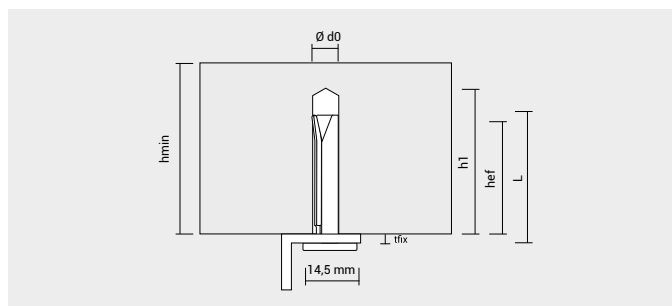
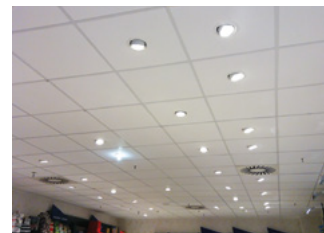
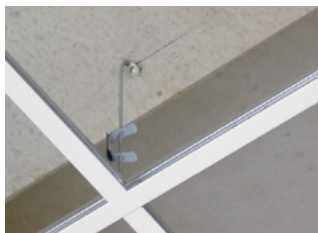

Características

- Homologado para la fijación en hormigón fisurado y no fisurado, el DA puede ser usado en un amplio rango de aplicaciones que requieran homologación.
- Altas cargas, reducidas distancias al borde y axiales.

Adecuado para materiales

- Hormigón
- Piedra maciza



Instalación

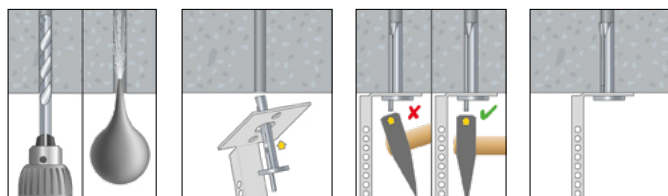

Cajas

DA					Precios		Envase	Embalaje
Ø [mm]	h ₁ ≥ [mm]	h _{ef} ≥ [mm]	L [mm]	t _{fix} ≥ [mm]	Código	Precio €/100 u.	(Uds.)	(Uds.)
6	30	25	30	4,5	965DA	41,60	100	1800
6	30	25	60	35	9635DA	84,60	100	1200

Cargas recomendadas Distancia entre anclajes y al borde

Denom.	Hormigón ≥ C20/25 F _{Per} [kN]	Ladrillo macizo MZ 12 F _{Rec} [kN]	Bloque macizo KSV 12 F _{Rec} [kN]	Distancia entre anclajes S _{min} [mm]	Distancia al borde. C _{min} [mm]	h _{min} [mm]
DA 6-30/5	0,95	0,60	0,40	200	150	80
DA 6-60/35	0,95	0,60	0,40	200	150	80

F_{Per}: Cargas según ETA, incluyendo factores de seguridad.

F_{Rec}: Cargas recomendadas incluyendo factor de seguridad 5 (Ladrillo macizo y bloque macizo no forman parte de la homologación).

h_{min}, S_{min} y C_{min}, no deben permanecer por debajo de los valores mínimos dados.

Anclaje tornillo directo a hormigón **BTS 5**



BTS5 B



BTS5 PT

Características

- Tornillo de fijación directa sin taco.
- Rápido y fácil de instalar -taladrar y atornillar-.
- Necesita taladro previo broca diámetro 5 mm.
- Se puede instalar con la mano, bajo par de inserción, gracias a la innovadora geometría de la rosca.
- Empotramiento reducido tan solo de 25 mm.
- Se puede fijar muy cerca de los bordes, hasta 50 mm.
- Dos tipos de cabeza hexagonal y cabeza alomada.
- Homologado al fuego con grapas metálicas tipo F y DF (CNBOP).
- Alta capacidad de carga hasta 80 kilos.
- Resistente a la corrosión hasta 480 horas, gracias al recubrimiento de láminas de zinc-aluminio.

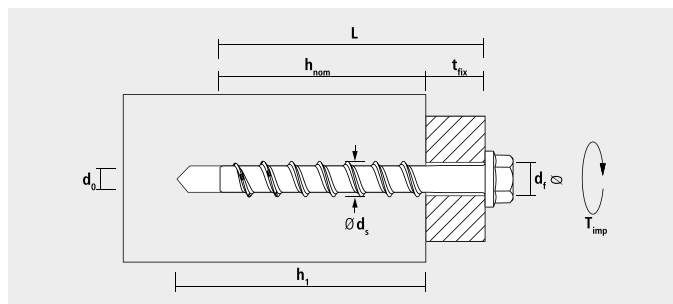
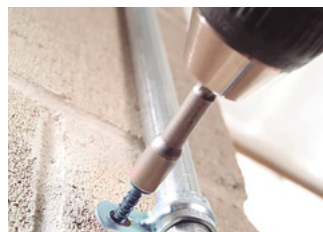

Instalación

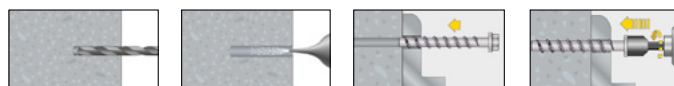

Adecuado para materiales

- Hormigón
- Hormigón alveolar
- Bloque de hormigón
- Ladrillo macizo

Cajas

BTS5 B Con cabeza hexagonal y arandela estampada Ø 11 mm, láminas Zn-Al.						Precios		Envase	Embalaje
Tipo d _s - L	d _s x L [mm]	h ₁ ≥ [mm]	h _{nom} ≥ [mm]	t _{fix} ≥ [mm]	Llave	Código	Precio €/100 u.	(Uds.)	(Uds.)
5-30/5	6,4X30	35	25	5	SW8	9ZG530BTSB	33,90	100	1800
5-45/20	6,4X45	35	25	20	SW8	9ZG545BTSB	36,60	100	1200
5-60/35	6,4X60	35	25	35	SW8	9ZG560BTSB	40,50	100	1200

BTS5 PT Con cabeza alomada (TX 25), Ø 10 mm, láminas Zn-Al.						Precios		Envase	Embalaje
Tipo d _s - L	d _s x L [mm]	h ₁ ≥ [mm]	h _{nom} ≥ [mm]	t _{fix} ≥ [mm]	Llave	Código	Precio €/100 u.	(Uds.)	(Uds.)
5-30/5	6,4X30	35	25	5	TX25	9ZG530BTSPT	25,10	100	1800
5-45/20	6,4X45	35	25	20	TX25	9ZG545BTSPT	27,40	100	1200
5-60/35	6,4X60	35	25	35	TX25	9ZG560BTSPT	30,90	100	1200

Cargas, espaciado y distancia de bordes Para múltiples usos para aplicaciones no estructurales en hormigón no fisurado C20/25-C50/60 F _{Rec} [kN]											
Denom.	Hormigón no agrietado ≥ C20/25		Hormigón agrietado ≥ C20/25		Ladrillo macizo MZ12 - Ladrillo macizo KSV12		Ladrillo hueco HLZ 12/ KSL 12 Grosor ≥ 15 mm		Espaciado S _{min} [mm]	Borde distancia S _{min} [mm]	Mín. espesor de la parte estructural h _{min} [mm]
	F _{Rec} [kN]	T _{inst max} [Nm]	F _{Rec} [kN]	T _{inst max} [Nm]	F _{Rec} [kN]	T _{inst max} [Nm]	F _{Rec} [kN]	T _{inst max} [Nm]			
BTS5	0,8	5	0,35	5	0,3	2	0,12	1	75	40	80

F_{Rec}: Carga recomendada incl. factor de seguridad 4.
 Para una profundidad de anclaje > 25 mm, la carga de tensión recomendada aumenta proporcionalmente

Anclaje tornillo directo a hormigón **BTS 6**



BTS6 B



BTS6 PT



BTS6 PTL



BTS6 E



BTS6 H

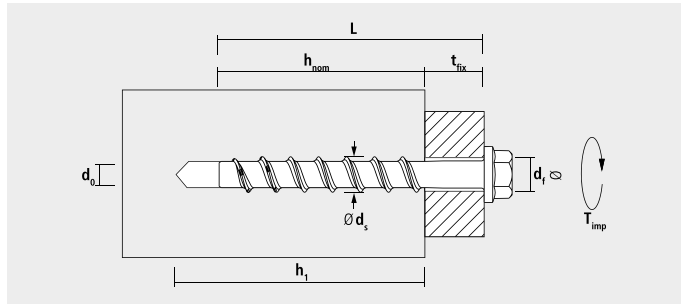

Características

- La fijación ideal para instalaciones en hormigón.
- Roscado fácil y seguro en hormigón.
- Carga inmediata después de instalarlo.
- Fijación de pletinas con agujeros sobredimensionados.
- Anclaje multifuncional y polivalente para diferentes cargas.
- Recomendado cuando hay distancias reducidas o poco espacio.
- Recomendamos atornillador de impacto.

Instalación

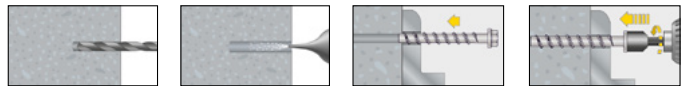

Adecuado para materiales

- Hormigón
- Hormigón prefabricado
- Piedra natural densa

Cajas

BTS6 B Con cabeza hexagonal y arandela estampada Ø 14 mm, láminas Zn-Al						Precios		Envase	Embalaje
Tipo d ₀ - L	d _s x L [mm]	h ₁ ≥ [mm]	h _{nom} ≥ [mm]	t _{fix} ≤ [mm]	Llave	Código	Precio €/100 u.	(Uds.)	(Uds.)
6-40/5	7,5 x 40	40	35	5	SW10	9ZG640BTSB	48,90	150	750
6-55/5	7,5 x 55	40 / 55	35 / 50	20 / 5	SW10	9ZG655BTSB	53,90	100	500

BTS6 PT Con cabeza alomada (TX 30), Ø 14,5 mm, láminas Zn-Al						Precios		Envase	Embalaje
Tipo d ₀ - L	d _s x L [mm]	h ₁ ≥ [mm]	h _{nom} ≥ [mm]	t _{fix} ≤ [mm]	Impronta	Código	Precio €/100 u.	(Uds.)	(Uds.)
6-40/5	7,5 x 40	40	35	5	TX30	9ZG640BTSPT	48,90	150	750
6-55/5	7,5 x 55	40 / 55	35 / 50	20 / 5	TX30	9ZG655BTSPT	53,90	100	500

BTS6 PTL Con cabeza botón (TX30), Ø19 mm, láminas Zn-Al.						Precios		Envase	Embalaje
Tipo d ₀ - L	d _s x L [mm]	h ₁ ≥ [mm]	h _{nom} ≥ [mm]	t _{fix} ≤ [mm]	Llave	Código	Precio €/100 u.	(Uds.)	(Uds.)
6-40/5	7,5 x 40	40	35	5	TX30	9ZG640BTSPTL	48,90	150	750
6-55/5	7,5 x 55	40 / 55	35 / 50	20 / 5	TX30	9ZG655BTSPTL	53,90	100	500

BTS6 E Con rosca externa, arandela Ø 14 mm, láminas Zn-Al						Precios		Envase	Embalaje
Tipo d ₀ - L	d _s x L [mm]	h ₁ ≥ [mm]	h _{nom} ≥ [mm]	Espárrago	Llave	Código	Precio €/100 u.	(Uds.)	(Uds.)
6-35	7,5 x 35	40	35	M6 (L = 5 mm)	SW10	9ZG635M6BTSE	60,90	150	750
6-35	7,5 x 35	40	35	M8 (L = 15 mm)	SW10	9ZG635M8BTSE	66,00	100	500

BTS6 H Con rosca interior, arandela M6 y M8: Ø 14 mm; M10: Ø 17 mm, láminas Zn-Al						Precios		Envase	Embalaje
Tipo d ₀ - L	d _s x L [mm]	h ₁ ≥ [mm]	h _{nom} ≥ [mm]	Rosca interior	Llave	Código	Precio €/100 u.	(Uds.)	(Uds.)
6-35	7,5 x 35	40	35	M6 (L = 10 mm)	SW10	9ZG635M6BTSH	62,60	150	750
6-35	7,5 x 35	40	35	M8 (L = 15 mm)	SW10	9ZG635M8BTSH	97,30	100	500
6-50	7,5 x 50	55	50	M8 (L = 15 mm)	SW10	9ZG650M8BTSH	109,30	100	500
6-35	7,5 x 35	40	35	M10 (L = 15 mm)	SW13	9ZG635M10BTSH	127,30	100	500

Accesorios **BTS 6**



Código: 6115SDSBTS6
Broca de 6 mm de diámetro especial para adaptador.
Longitud útil de 105 mm



Código: 910LLTRBCA
Adecuado para todos los tamaños de BTS6 con SW10.



Código: 9ATRBCA
Adaptador especial.
Colocar sobre la broca y la llave de vaso.

Instalación

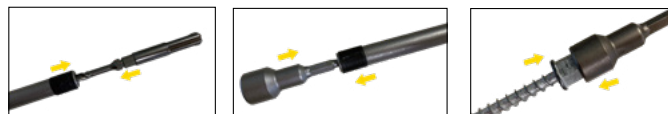

Taladra y atornilla con la misma herramienta.



Vídeo accesorios BTS 6.

Accesorios Para tornillo para hormigón BTS6		Precios		Envase
d_0 [mm]	L [mm]	Código	Precio €/u.	(Uds.)
6	175	6115SDSBTS6	12,30	1
13	145	9ATRBCA	33,80	1
18	65	910LLTRBCA	44,00	1

Cargas, espaciado y distancia de bordes Para múltiples usos para aplicaciones no estructurales en hormigón fisurado C20/25-C50/60

Denom.	Carga permitida en cualquier dirección ¹⁾²⁾		Momento de flexión permitido M_{Per} [Nm]	Distancia entre anclajes		Distancia a los bordes		Grosor hormigón h_{min} [mm]	Par máximo de la llave de impacto $T_{imp,s}$ [Nm]
	h_{nom} 35 mm F_{per} [kN]	h_{nom} 50 mm F_{per} [kN]		S_{cr} [mm]	S_{min} [mm]	C_{cr} [mm]	C_{min} [mm]		
BTS 6-35	0,85	–	5,7	160	40	80	40	100	150
BTS 6-40	0,85	–	5,7	160	40	80	40	100	150
BTS 6-50	0,85	1,90	5,7	160	40	80	40	100	150
BTS 6-55	0,85	1,90	5,7	160	40	80	40	100	150

1) Cargas permitidas sin influencia de espaciado y distancia de bordes.

2) Las cifras de carga incluyen los factores de seguridad parciales de las resistencias según la aprobación y un factor de seguridad parcial en acción de $\gamma_F = 1.4$. Si no se cumple con las distancias características (C_{cr} o S_{cr}) las cargas se deben reducir. Siempre deben cumplirse las distancias mínimas (S_{min} y C_{min}).

Cargas, espaciado y distancia al borde Para uso múltiple para aplicaciones no estructurales en losas prefabricadas de hormigón hueco C45 / 55

Denom.	Carga permitida en cualquier dirección ¹⁾²⁾ h_{nom} 35 mm F_{per} [kN]	Momento de flexión permitido M_{Per} [Nm] ²	Distancia entre anclajes		Distancia a los bordes	
			S_{cr} [mm]	S_{min} [mm]	C_{cr} [mm]	C_{min} [mm]
BTS 6	1,02	5,7	200	200	150	150

1) Cargas permitidas sin influencia de espaciado y distancia de bordes.

2) Las cifras de carga incluyen los factores de seguridad parciales de las resistencias según la aprobación y un factor de seguridad parcial en la acción de $\gamma_F = 1.4$. Si no se cumple con las distancias características (C_{cr} o S_{cr}) las cargas se deben reducir. Siempre deben cumplirse las distancias mínimas (S_{min} y C_{min}).

Cargas, espaciado y distancia al borde para aplicaciones no estructurales en losas de núcleo hueco de hormigón prefabricado: $w / e \leq 4,2$ / hormigón $\geq C45 / 55$ / espesor del borde inferior ≥ 35 mm.

Anclaje tornillo directo a hormigón **BTS 8/10/14**



BTS B



BTS ST

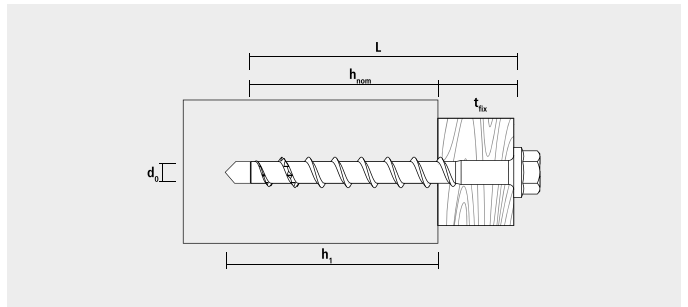
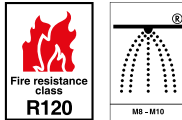

Características

- Homologado opción 1 para hormigón fisurado y no fisurado.
- Reducción de un 50% del tiempo en la fijación de anclajes de altas cargas, taladrar y fijar. Fijación pasante. Carga inmediata. No necesita control del par de apriete.
- Multifuncional y polivalente para diferentes espesores del hormigón.
- Recomendado cuando hay reducidas distancias o poco espacio.
- Roscado fácil y seguro en hormigón.
- Recomendamos atornillador de impacto.

Instalación

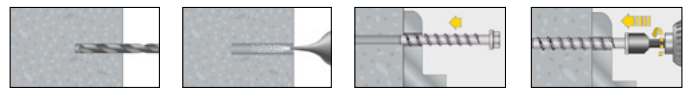

Adecuado para materiales

- Hormigón
- Piedra natural densa



Cajas

BTS B Con cabeza hexagonal y arandela estampada. Cincado, láminas Zn-Al							Precios		Envase	Embalaje
Tipo	d ₀ [mm]	h ₁ ≥ [mm]	h _{nom} ≥ [mm]	L [mm]	t _{fix} ≥ [mm]	Llave	Código	Precio €/100 u.	(Uds.)	(Uds.)
• 8-50/-	8	55 / - / -	45 / - / -	50	5 / - / -	SW 13	9ZG850BTSB	122,30	50	250
8-70/5	8	55 / 65 / 75	45 / 55 / 65	70	25 / 15 / 5	SW 13	9ZG870BTSB	135,10	50	250
8-80/15	8	55 / 65 / 75	45 / 55 / 65	80	35 / 25 / 15	SW 13	9ZG880BTSB	141,40	50	250
8-90/25	8	55 / 65 / 75	45 / 55 / 65	90	45 / 35 / 25	SW 13	9ZG890BTSB	154,30	50	250
• 10-60/-	10	65 / - / -	55 / - / -	60	5 / - / -	SW 15	9ZG1060BTSB	180,00	50	250
10-90/5	10	65 / 85 / 95	55 / 75 / 85	90	35 / 15 / 5	SW 15	9ZG1090BTSB	205,70	40	200
10-100/15	10	65 / 85 / 95	55 / 75 / 85	100	45 / 25 / 15	SW 15	9ZG10100BTSB	231,40	40	200
10-120/35	10	65 / 85 / 95	55 / 75 / 85	120	65 / 45 / 35	SW 15	9ZG10120BTSB	257,10	40	200
10-140/55	10	65 / 85 / 95	55 / 75 / 85	140	85 / 65 / 55	SW 15	9ZG10140BTSB	308,70	30	150
10-160/75	10	65 / 85 / 95	55 / 75 / 85	160	105 / 85 / 75	SW 15	9ZG10160BTSB	372,90	30	150
10-180/95*	10	65 / 85 / 95	55 / 75 / 85	180	125 / 105 / 95	SW 15	9ZG10180BTSB	488,60	20	100
10-200/115*	10	65 / 85 / 95	55 / 75 / 85	200	145 / 125 / 115	SW 15	9ZG10200BTSB	514,40	20	80
10-240/155*	10	65 / 85 / 95	55 / 75 / 85	240	185 / 165 / 155	SW 15	9ZG10240BTSB	604,40	20	80
10-280/195*	10	65 / 85 / 95	55 / 75 / 85	280	225 / 205 / 195	SW 15	9ZG10280BTSB	694,40	20	80
• 14-80/-	14	85 / - / -	75 / - / -	80	5 / - / -	SW 21	9ZG1480BTSB	655,80	20	100
• 14-110/-	14	85 / 110 / -	75 / 100 / -	110	35 / 10 / -	SW 21	9ZG14110BTSB	784,40	20	100



Diámetro de cabeza: BTS 8: Ø 16.2 mm; BTS 10: Ø 20.0 mm; BTS 14: Ø 30,0 mm
 * Con arandela ancha según ISO7094 (DIN 440) para la construcción con madera.
 • Sin homologación sísmica

BTS B Con cabeza hexagonal y arandela estampada. Acero inoxidable A4.							Precios		Envase	Embalaje
Tipo	d ₀ [mm]	h ₁ ≥ [mm]	h _{nom} ≥ [mm]	L [mm]	t _{fix} ≥ [mm]	Llave	Código	Precio €/100 u.	(Uds.)	(Uds.)
8-80/15	8	55 / 65 / 75	45 / 55 / 65	80	35 / 25 / 15	SW 13	9X880BTSB	639,00	50	250
10-90/5	10	65 / 85 / 95	55 / 75 / 85	90	35 / 15 / 5	SW 15	9X1090BTSB	924,40	40	200
10-100/15	10	65 / 85 / 95	55 / 75 / 85	100	45 / 25 / 15	SW 15	9X10100BTSB	978,80	40	200

Diámetro de cabeza: BTS 8: Ø 16.2 mm; BTS 10: Ø 20.0 mm; BTS 14: Ø 30,0 mm
 * con arandela ancha según ISO7094 (DIN 440) para la construcción con madera.

BTS ST Con cabeza avellanada, cincado.							Precios		Envase	Embalaje
Tipo	d_0 [mm]	$h_1 \geq$ [mm]	$h_{nom} \geq$ [mm]	L [mm]	$t_{fx} \geq$ [mm]	Impronta	Código	Precio €/100 u.	 (Uds.)	 (Uds.)
8-80/15	8	55 / 65 / 75	45 / 55 / 65	80	35 / 25 / 15	TX 40	9880BTSST	192,90	50	250
10-90/5	10	65 / 85 / 95	55 / 75 / 85	90	35 / 15 / 5	TX 50	91090BTSST	270,00	40	200

Recubrimiento Zn-Al. Diámetro de cabeza: BTS ST 8: Ø 19,5 mm; BTS ST 10: Ø 21,5 mm

BTS ST Con cabeza avellanada, acero inoxidable A4.							Precios		Envase	Embalaje
Tipo	d_0 [mm]	$h_1 \geq$ [mm]	$h_{nom} \geq$ [mm]	L [mm]	$t_{fx} \geq$ [mm]	Impronta	Código	Precio €/100 u.	 (Uds.)	 (Uds.)
8-80/15	8	55 / 65 / 75	45 / 55 / 65	80	35 / 25 / 15	TX 40	9X880BTSST	666,10	50	250
10-90/5	10	65 / 85 / 95	55 / 75 / 85	90	35 / 15 / 5	TX 50	9X1090BTSST	1060,40	40	200

Tipo BTS ST: Acero inoxidable A4. Diámetro de cabeza: BTS ST 8: Ø 19,5 mm; BTS ST 10: Ø 21,5 mm

Cargas recomendadas, parámetros para la instalación Los valores son aplicables a BTS en acero al carbono y acero inoxidable.

		BTS 8			BTS 10			BTS 14		
Ø Taladro	d_0 [mm]	8			10			14		
Ø Rosca	d_s [mm]	10,6			12,6			16,6		
Agujero pasante	$d_t \leq$ [mm]	12			14			18		
Profundidad de anclaje	h_{nom} [mm]	45	55	65	55	75	85	75	100	115
Carga a tracción permitida en hormigón fisurado ^{1), 2), 3)}										
C20/25	N_{per} [kN]	2,4	4,3	5,7	4,3	8,0	9,6	7,6	12,0	15,1
Carga a tracción permitida en hormigón no fisurado ^{1), 2), 3)}										
C20/25	N_{per} [kN]	3,6	5,7	7,6	5,7	9,5	11,9	10,6	16,9	21,2
Carga de cizallamiento en hormigón fisurado										
C20/25	V_{per} [kN]	3,5	4,8	6,4	4,8	15,9	19,2	7,6	24,1	30,3
Carga de cizallamiento en hormigón no fisurado										
C20/25	V_{per} [kN]	5,0	6,8	9,0	6,8	19,4	19,4	10,6	32,0	32,0
Momento flector permitido	M_{per} [Nm]	15			32			106		
Distancias entre anclajes y al borde										
Distancia entre anclajes ⁴⁾	$s_{cr,N}$ [mm]	105	129	156	129	180	204	174	237	276
Distancia al borde ⁴⁾	$c_{cr,N}$ [mm]	53	65	78	65	90	102	87	119	138
Distancia entre anclajes mín. ⁴⁾	s_{min} [mm]	40	50	50	50	50	50	50	70	70
Distancia al borde mín. ⁴⁾	c_{min} [mm]	40	50	50	50	50	50	50	70	70
Grosor mínimo de hormigón	h_{min} [mm]	100	100	100	100	130	130	130	150	170
Par de instalación máx. para atornillador de impacto	$T_{inst} \leq$ [Nm]	300			400			500		

¹⁾ Cargas permitidas de un anclaje individual sin influencias desde los bordes ni entre anclajes.

²⁾ Los datos sobre las cargas tienen en cuenta los coeficientes de seguridad parciales establecidos en la aprobación para las resistencias, así como un coeficiente de seguridad de las influencias de $\gamma_c = 1,4$.

³⁾ En el caso de durezas de hormigón superiores a C50/60, los valores de carga de tracción se incrementan hasta un 55% en comparación con C20/25.

⁴⁾ Los valores intermedios se pueden interpolar de forma lineal entre S_{cr} y S_{min} / C_{cr} y C_{min} . Los valores nunca pueden estar por debajo de S_{min} y C_{min} .

Anclaje metálico antigiro

DT, DV, DA, DG



DT con Cabeza Hexagonal.



DV con Cabeza Avellanada TX40.



DA con Aro.



DG con Gancho



Ø9 Ø11 Ø14
Ø16 Ø21 Ø26

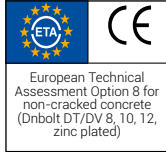

European Technical Assessment Option 8 for non-cracked concrete (Dnbolt DT/DV 8, 10, 12, zinc plated)

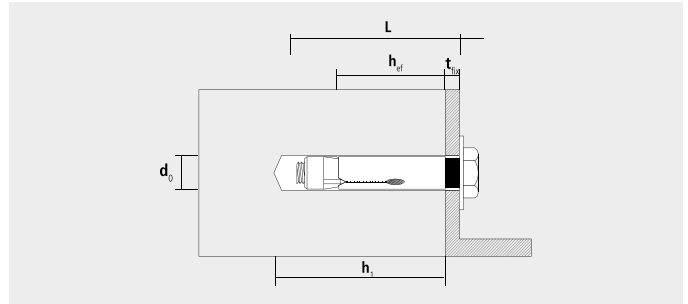
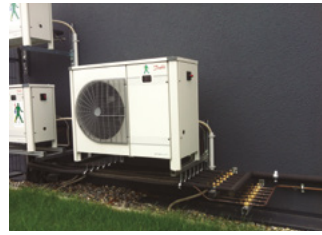

Características

- La fijación ideal para cargas medias de hasta 1.000 Kg.
- Referencias DT y DV con homologación ETA para hormigón no fisurado.
- Cono antirotación con estrías para una segura expansión.
- La camisa permite una perfecta fijación en la superficie.

Adecuado para materiales

- Hormigón
- Piedra natural densa
- Ladrillo macizo

Cajas

DT Cincado								Precios		Envase	Embalaje
Ø [mm]	h ₁ ≥ [mm]	h _{ef} ≥ [mm]	L [mm]	t _{fix} ≥ [mm]	Rosca		Código	Precio €/100 u.			
8	45	30	45	5	M6	●	9845DT	31,60	250	1000	
8	45	30	45	5	M6	●	9845DT50	38,60	50	900	
8	45	30	60	20	M6	●	9860DT	38,60	200	800	
8	45	30	60	20	M6	●	9860DT30	46,80	30	540	
9	45	30	45	5	M6	-	9945DT	37,00	200	800	
9	45	30	60	20	M6	-	9960DT	41,50	150	600	
10	55	37	60	10	M8	●	91060DT	50,20	100	400	
10	55	37	60	10	M8	●	91060DT20	57,90	20	360	
10	55	37	80	30	M8	●	91080DT	60,30	15	60	
10	55	37	80	30	M8	●	91080DT15	71,60	15	270	
11	55	37	60	10	M8	-	91160DT	58,20	100	400	
11	55	37	80	30	M8	-	91180DT	65,90	75	300	
12	65	45	70	10	M10	●	91270DT	83,50	50	200	
12	65	45	100	40	M10	●	912100DT	105,40	50	200	
14	65	45	70	10	M10	-	91470DT	96,00	50	200	
14	65	45	100	40	M10	-	914100DT	120,10	50	200	
16	75	55	80	10	M12	-	91680DT	137,40	40	160	
16	75	55	110	40	M12	-	916110DT	182,10	25	100	
21	85	65	110	30	M16	-	921110DT	334,50	10	40	
26	105	80	130	30	M20	-	926130DT	845,50	8	32	

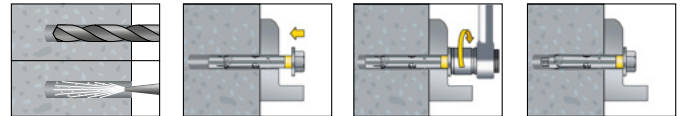

Instalación





Bolsas



DT Cincado	Precios		Envase	Embalaje	Embalaje
Ø mm	Código	Precio €/Bolsa			
10	1080DT	4,00	4 (Uds.)	15 (Bolsas)	60 (Uds.)
12	1270DT	6,20	4 (Uds.)	15 (Bolsas)	60 (Uds.)
12	12100DT	7,20	4 (Uds.)	15 (Bolsas)	60 (Uds.)



Cajas

DT Acero Inoxidable A2							Precios		Envase	Embalaje
Ø [mm]	h ₁ ≥ [mm]	h _{ef} ≥ [mm]	L [mm]	t _{fix} ≥ [mm]	Rosca	Código	Precio €/100 u.			
8	45	30	45	5	M6	9X845DT	172,80	250	1000	
8	45	30	60	20	M6	9X860DT	193,00	200	800	
9	45	30	45	5	M6	9X945DT	213,40	200	800	
10	55	37	60	10	M8	9X1060DT	284,60	100	400	
10	55	37	80	30	M8	9X1080DT	325,30	100	400	
11	55	37	60	10	M8	9X1160DT	334,00	100	400	
11	55	37	80	30	M8	9X1180DT	355,70	75	300	
12	65	45	70	10	M10	9X1270DT	447,10	50	200	
12	65	45	100	40	M10	9X12100DT	548,80	50	200	
14	65	45	100	40	M10	9X14100DT	797,90	50	200	
16	75	55	80	10	M12	9X1680DT	1016,20	40	160	

DV Cincado							Precios		Envase	Embalaje
Ø [mm]	h ₁ ≥ [mm]	h _{ef} ≥ [mm]	L [mm]	t _{fix} ≥ [mm]	Rosca		Código	Precio €/100 u.		
10	55	37	60	10	M8	•	91060DV	87,70	100	400
10	55	37	80	30	M8	•	91080DV	141,70	100	400

Con tornillo Avellanado TX40.

DA Cincado							Precios		Envase	Embalaje
Ø [mm]	h ₁ ≥ [mm]	h _{ef} ≥ [mm]	L [mm]	t _{fix} ≥ [mm]	Rosca	Diámetro Aro Ø	Código	Precio €/100 u.		
8	45	30	45	5	M6	12	9845DA25	66,10	25	450
8	45	30	45	5	M6	12	9845DA	54,10	100	400
9	45	30	45	5	M6	12	9945DA	56,60	100	400
10	55	37	80	30	M8	13	91060DA10	104,50	10	180
10	55	37	80	30	M8	13	91060DA	87,70	50	200

DG Cincado							Precios		Envase	Embalaje
Ø [mm]	h ₁ ≥ [mm]	h _{ef} ≥ [mm]	L [mm]	t _{fix} ≥ [mm]	Rosca	Código	Precio €/100 u.			
8	45	30	45	5	M6	9845DG25	66,10	25	450	
8	45	30	45	5	M6	9845DG	54,10	100	400	
9	45	30	45	5	M6	9945DG	53,90	100	400	
10	55	37	60	10	M8	91060DG	87,70	50	200	

* Hasta fin de existencias.

Cargas recomendadas Espacio entre anclajes y al borde - de acuerdo con la homologación CE en hormigón no fisurado.

	d ₀ [mm]	Rosca	Par instalación T _{inst} [Nm]	Hormigón no fisurado ≥ C20/25			Momento de flexión permitido		Espacio entre anclajes		Distancia al borde		Espesor mín. hormigón h _{min} [mm]
				N _{per} [kN]	V _{per} [kN]	V _{per} [kN]	Acero 6.8	Acero 8.8	Acero 6.8	Acero 8.8*	S _{cr} [mm]	S _{min} [mm]	
DNBOLT 8	8	M6	10	2,9	3,4	4,0	5,3	7,0	90	40	45	40	100
DNBOLT 10	10	M8	15	3,6	5,4	5,4	12,9	17,1	111	50	56	50	100
DNBOLT 12	12	M10	30	4,8	6,8	6,8	25,7	34,2	129	60	65	60	110

N_{per}: Carga a tracción permitida con los factores de seguridad incluidos según ETAG 001.

V_{per}: Carga a cizalla permitida con los factores de seguridad incluidos según ETAG 001.

M_{per}: Momento de flexión con los factores de seguridad según ETAG 001.

* Dnbolts con acero 8.8 solo bajo demanda.

Cargas de trabajo recomendadas Para anclajes no homologados en hormigón C20/C25 no fisurado

Denom.	d ₀ [mm]	Rosca	Par instalación T _{inst} [Nm]	Calidad 6.8		Acero inoxidable A2	
				Carga a tracción N _{rec} [kN]	Carga a cizalla V _{rec} [kN]	Carga a tracción N _{rec} [kN]	Carga a cizalla V _{rec} [kN]
DNBOLT 8	8	M6	10	-	-	1,8	2,0
DNBOLT 10	10	M8	15	-	-	2,0	3,2
DNBOLT 12	12	M10	30	-	-	3,4	4,8
DNBOLT 14	14	M10	30	6,2	8,6	3,5	5,6
DNBOLT 16	16	M12	65	7,5	12,0	4,8	8,5
DNBOLT 20	20	M16	150	8,9	26,0	-	-
DNBOLT 25	25	M20	300	10,6	28,8	-	-

Factores de seguridad incluidos.

Cargas recomendadas Para anclajes Dnbolt aro y Dnbolt gancho no homologados en hormigón C20/C25 no fisurado

	Rosca	d ₀ [mm]	DA - F _{rec} [kN]	DG - F _{rec} [kN]
DNBOLT 8	M6	8	0,6	0,6
DNBOLT 9	M6	9	0,6	0,6
DNBOLT 10	M8	10	0,6	0,6
DNBOLT 11	M8	11	0,6	0,6
DNBOLT 16	M12	16	0,6	0,6

Factores de seguridad incluidos

Taco hembra cono expansor SAPK / SAP / ESW



SAPK



SAP



ESW



ESWP

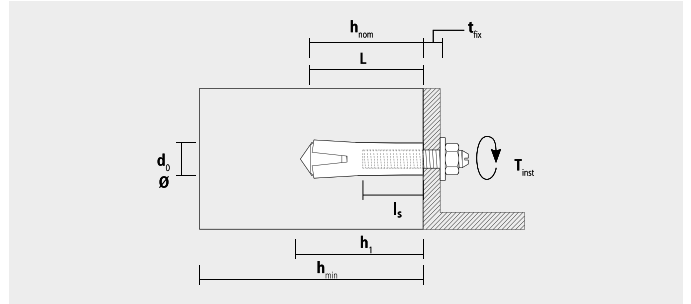

Características

- El taco de retacar SA plus está homologado opción 7 para hormigón no fisurado y para múltiples usos en aplicaciones no estructurales para hormigón fisurado.
- Permite un agujero y un empotramiento pequeño.
- La herramienta de expansión es necesaria para una correcta instalación.
- Las referencias 9825SAPK y 91025SAPK son de empotramiento reducido ideales para placa alveolar prefabricada.

Instalación

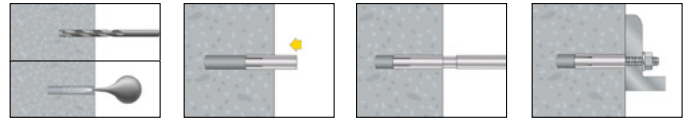

Cajas

SAPK Cincado con valona						Precios		Envase	Embalaje
d_0 [mm]	$h_1 \geq$ [mm]	L [mm]	l_s min-máx [mm]	Rosca	Código	Precio €/100 u.			
8	27	25	6-11	M6	96SAPK	36,30	100	1800	
10	27	25	6-12	M8	9825SAPK	40,60	100	1800	
10	32	30	8-13	M8	98SAPK	43,00	100	1000	
12	27	25	8-12	M10	91025SAPK	51,10	50	900	
12	43	40	10-16	M10	910SAPK	70,70	50	500	
15	54	50	12-23	M12	912SAPK	118,80	50	300	
20	70	65	16-32	M16	916SAPK	292,80	25	150	

SAP Cincado						Precios		Envase	Embalaje
d_0 [mm]	$h_1 \geq$ [mm]	L [mm]	l_s min-máx [mm]	Rosca	Código	Precio €/100 u.			
8	27	25	6-11	M6	96SAP	28,90	100	1800	
10	32	30	8-13	M8	98SAP	34,60	100	1000	
12	43	40	10-16	M10	910SAP	56,50	50	500	
15	54	50	12-23	M12	912SAP	95,10	50	300	
20	70	65	16-32	M16	916SAP	234,10	25	150	

ESW Para SAP / SAPK		Precios		Envase
Denom.	Código	Precio €/100 u.		Unidad
ESW 6	96ESW	21,10	1	1
ESW 8	98ESW	34,30	1	1
ESW 10	910ESW	39,50	1	1
ESW 12	912ESW	42,70	1	1
ESW 16	916ESW	46,50	1	1

ESWP Para SAP / SAPK		Precios		Envase
Denom.	Código	Precio €/100 u.		Unidad
ESW PRO 6	96ESWP	34,30	1	1
ESW PRO 8	98ESWP	35,70	1	1
ESW PRO 10	910ESWP	36,20	1	1
ESW PRO 12	912ESWP	39,20	1	1
ESW PRO 16	916ESWP	40,30	1	1

Blisters

SAPK	Precios		Envase	Embalaje	Embalaje
\emptyset [mm]	Código	Precio €/Blister			
8	6SAPK	11,20	10	15	150
10	8SAPK	11,20	8	15	120
12	10SAPK	11,20	6	15	90

Cargas, espaciado y distancia al borde Para anclaje simple en hormigón no fisurado C20 / 25

Denom.	Carga de tensión admisible ^{1),2),3)} (Tornillo 4.6-8.8)	Carga de cizallamiento permitida ^{1),2)}		Momento de flexión permitido ²⁾		Espaciado	Distancia del borde	Mín. espesor de la parte estructural	Par de apriete	Ø del agujero pasante
		(Tornillo 4.6)	(Tornillo 8.8)	(Tornillo 4.6)	(Tornillo 8.8)					
		N _{per} [kN]	V _{per} [kN]	V _{per} [kN]	M _{per} [Nm]					
SAP/SAK plus 8	3,6	3,1	4,0	6,4	17,1	105	105	100	8	9
SAP/SAK plus 10	4,8	4,5	4,5	12,8	34,2	105	140	100	15	12
SAP/SAK plus 12	6,3	7,3	7,3	22,4	59,8	125	175	120	35	14
SA/SAK plus 16	10,5	12,2	12,2	56,8	151,7	180	230	160	60	18

¹⁾ Cargas admisibles para anclajes individuales sin influencia del espaciado y la distancia al borde.

²⁾ Las cifras de carga incluyen los factores de seguridad parcial de las resistencias según la aprobación y un factor de seguridad parcial en la acción de $v_f = 1.4$.

³⁾ Para mayores resistencias de hormigón hasta C50 / 55, los valores aumentan en máx. 55%. Deben observarse h_{min}, S_{min} y C_{min}.

Cargas, espaciado y distancia al borde Uso múltiple para aplicaciones no estructurales en hormigón fisurado C20 / 25-C50 / 60

Denom.	Carga admisible en cualquier dirección ^{1),2)} (Tornillo 4.6-8.8)	Momento de flexión permisible ²⁾		Espaciado	Distancia del borde	Mín. espesor de la parte estructural	Par de apriete	Ø del agujero pasante
		(Tornillo 4.6)	(Tornillo 8.8)					
		F _{per} [kN]	M _{per} [Nm]					
SAP/SAK plus 6	0,5	2,6	7,0	70	105	100	4	7
SAK plus 8-25	1,0	6,4	17,1	120	110	100	8	9
SAP/SAK plus 8	1,2	6,4	17,1	105	105	100	8	9
SAK plus 10-25	1,0	12,8	34,2	130	140	100	15	12
SAP/SAK plus 10	3,0	12,8	34,2	105	140	100	15	12

¹⁾ Cargas admisibles para anclajes individuales sin influencia del espaciado y la distancia al borde.

²⁾ Las cifras de carga incluyen los factores de seguridad parcial de las resistencias según la aprobación y un factor de seguridad parcial en la acción de $v_f = 1.4$.

Para mayores resistencias de hormigón hasta C50 / 55, los valores aumentan en máx. 55%. h_{min}, S_{min} y C_{min}.

Cargas, espaciado y distancia al borde Para uso múltiple para aplicaciones no estructurales en losas prefabricadas de hormigón hueco C45 / 55.

Denom.	Carga admisible en cualquier dirección ^{1),2)} (Tornillo 4.6-8.8)	Momento de flexión permitido ²⁾		Espaciado	Distancia del borde	Mín. espesor de la parte estructural	Par de apriete	Ø del agujero pasante
		(Tornillo 4.6)	(Tornillo 8.8)					
		F _{per} [kN]	M _{per} [Nm]					
SAK plus 8-25	1,0	6,4	17,1	120	110	100	8	9
SAK plus 10-25	1,0	12,8	34,2	130	140	100	15	12

¹⁾ Cargas permisibles sin influencia de espaciado y distancia al borde.

²⁾ Las cifras de carga incluyen los factores de seguridad parcial de las resistencias según la aprobación y un factor de seguridad parcial en la acción de $v_f = 1.4$.

Deben observarse h_{min}, S_{min} y C_{min}.

Anclaje espárrago BA plus



BA Plus, cincado.

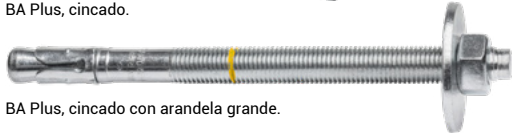

BA Plus, cincado con arandela grande.



Características

- Es adecuado para una amplia variedad de instalaciones en diámetros M6 - M20.
- El cono de expansión redondeado facilita la instalación del anclaje.
- El marcado de la profundidad en el anclaje facilita la preinstalación.
- Una larga zona roscada aporta mayor flexibilidad de instalación.
- Homologado opción 7 para hormigón no fisurado.

Cajas

BA plus							Precios		Envase	Embalaje
d_b [mm]	$h_1 \geq$ [mm]	$h_{eff} \geq$ [mm]	L [mm]	$t_{fix} \leq$ [mm]	$t_{inst} \geq$ [Nm]	Código	Precio €/100 u.	(Uds.)	(Uds.)	
6	38	25	45	5	15	⁽¹⁾ 9645BAP	47,30	100	500	
	48	35	60	10	15	9660BAP	59,60	100	500	
	48	35	80	30	15	9680BAP	68,50	100	500	
	48	35	100	50	15	96100BAP	72,50	100	500	
	40	25	50	5	-	⁽¹⁾ 9850BAP	62,50	100	500	
8	60	45	75	10	15	9875BAP	65,80	50	250	
	60	45	85	20	15	9885BAP	71,60	50	250	
	60	45	95	30	15	9895BAP	74,60	50	250	
	60	45	115	50	15	98115BAP	87,70	40	200	
	60	45	135	70	15	98135BAP	96,40	40	200	
	42	27	60	10	-	⁽¹⁾ 91060BAP	97,40	50	250	
	55	40	75	10	-	⁽¹⁾ 91075BAP	105,10	50	250	
10	65	50	85	10	30	91085BAP	96,40	40	200	
	65	50	92	17	30	91092BAP	96,40	40	200	
	65	50	105	30	30	910105BAP	112,40	25	125	
	65	50	125	50	30	910125BAP	114,80	25	125	
	65	50	145	70	30	910145BAP	148,90	25	125	
	65	50	175	100	30	910175BAP	182,60	25	125	
	65	50	215*	140	30	910215BAP	255,60	25	100	
	58	38	70	2	-	⁽¹⁾ 91270BAP	121,50	50	250	
	90	70	110	10	50	912110BAP	146,00	20	100	
	90	70	120	20	50	912120BAP	182,60	20	100	
12	90	70	130	30	50	912130BAP	197,20	20	100	
	90	70	150	50	50	912150BAP	226,50	20	100	
	90	70	180	80	50	912180BAP	263,00	20	100	
	90	70	200	100	50	912200BAP	335,90	20	80	
	90	70	220*	120	50	912220BAP	350,60	20	80	
	90	70	240*	140	50	912240BAP	408,90	20	100	
	90	70	260*	160	50	912260BAP	423,70	20	80	
	90	70	300*	200	50	912300BAP	467,30	15	30	
	90	70	320*	220	50	912320BAP	511,20	15	15	
	16	75	50	95	10	-	⁽¹⁾ 91695BAP	315,00	15	75
110		85	135	15	90	916135BAP	328,60	10	50	
110		85	150	30	90	916150BAP	357,90	10	50	
110		85	180	60	90	916180BAP	438,00	10	50	
110		85	200	80	90	916200BAP	569,60	10	50	
110		85	220*	100	90	916220BAP	598,80	10	40	
110		85	270*	150	90	916270BAP	744,90	10	40	
110		85	320*	200	-	916320BAP	638,10	10	40	
90		60	110	10	-	⁽¹⁾ 920110BAP	589,90	10	40	
130		100	160	20	-	920160BAP	685,30	10	40	
20	130	100	215	75	-	920215BAP	897,40	6	24	
	130	100	270	130	-	920270BAP	1036,70	5	20	

⁽¹⁾ Sin homologación ETA.

* Arandela grande para carpintería.

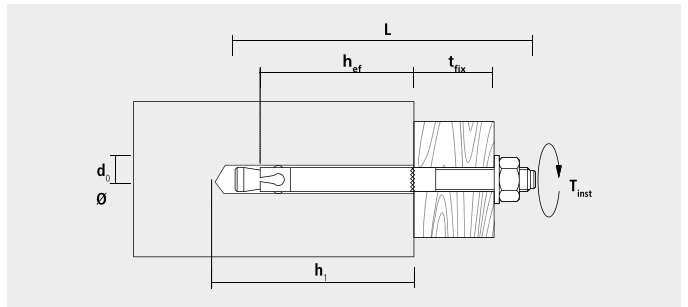
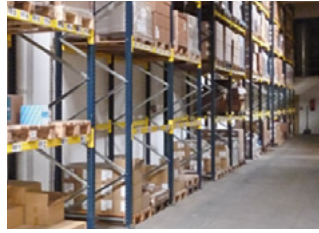

Instalación

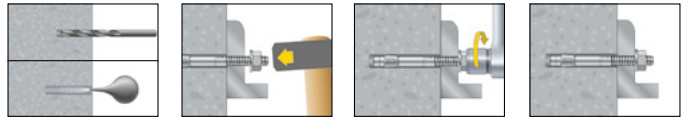

Bolsas

BA plus	Precios		Envase	Embalaje	Embalaje
\emptyset mm	Código	Precio €/Bolsa	(Uds.)	(Bolsas)	(Uds.)
10	10145BAP	4,90	2	15	30
16	16135BAP	11,90	2	15	30

Datos instalación

BAP	Medidas					
	M6	M8	M10	M12	M16	M20
Par de apriete T_{inst} [Nm]	8	15	30	50	110	180
Llave de Vaso SW	10	13	17	19	24	30
Diámetro agujero pieza a fijar [mm]	7	9	12	14	18	22
Arandela \emptyset x grosor [mm]	12 x 1,6	16x1,6	20x2/34x3	24x2,5/44x4	30x3/56x5	37x3

Distancias entre anclajes y al borde

BAP	Medidas						
	M6	M8	M10	M12	M16	M20	
Distancia entre anclajes	S_{cr} [mm]	105	135	150	210	255	300
	S_{min} [mm]	50	50	120	70	100	160
Distancia al borde	C_{cr} [mm]	53	68	75	105	128	150
	C_{min} [mm]	50	50	90	90	100	150
Espesor mínimo	h_{min} [mm]	100	100	120	160	200	200

Cargas recomendadas

BAP	Medidas						
	M6	M8	M10	M12	M16	M20	
Cargas Recomendadas	Tracción N_{per} [kN] ^(1,2)	1,5	1,5	1,8	2,4	4,0	6,0
	Cizalla V_{per} [kN]	1,5	1,5	1,8	2,4	4,0	6,0
	Profundidad anclaje h_{eff} [mm]	25	25	27	38	50	60

(1) Según se observa en la homologación ETA-12/0142.

(2) Tiene en cuenta factores de seguridad especificados en la homologación, así como un factor de seguridad parcial de la acción de $\xi F=1,4$.

Anclaje espárrago BAZ



BAZ, cincado.



BAZ A4, inoxidable A4



BAZ HD, galvanizado



FIJACIÓN

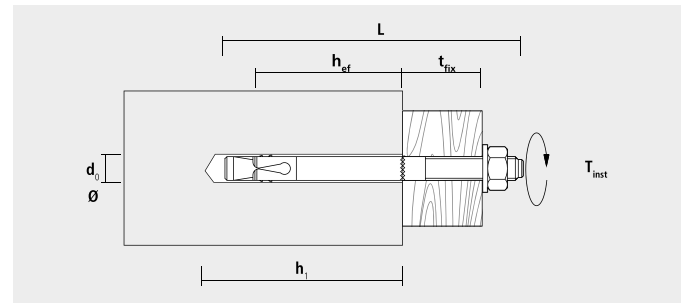

Características

- Homologado opción 1 para la fijación en hormigón fisurado y no fisurado, el BAZ puede ser usado en un amplio rango de aplicaciones que requieran homologación.
- Altas cargas, reducidas distancias al borde y axiales.

Adecuado para materiales

- Hormigón
- Piedra natural densa

Instalación

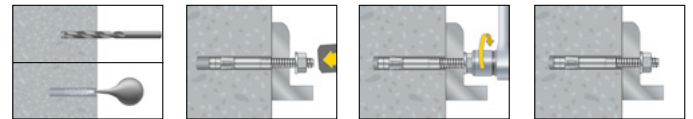

Cajas

BAZ Cincado						Precios		Envase	Embalaje
Ø [mm]	h _i ≥ [mm]	h _{ef} ≥ [mm]	L [mm]	t _{fix} ≥ [mm]	Rosca	Código	Precio €/100 u.	(Uds.)	(Uds.)
8	60	45	72	10	M 8	9872BAZ	114,90	50	250
	60	45	92	30	M 8	9892BAZ	138,80	50	250
	60	45	112	50	M 8	98112BAZ	157,90	40	200
	60	45	147	85	M 8	98147BAZ	191,40	40	200
10	75	60	92	10	M 10	91092BAZ	170,50	40	200
	75	60	102	20	M 10	910102BAZ	199,50	25	125
	75	60	112	30	M 10	910112BAZ	217,00	25	125
	75	60	132	50	M 10	910132BAZ	242,50	25	125
	75	60	162	80	M 10	910162BAZ	263,20	25	125
12	90	70	103	5	M 12	912103BAZ	245,50	20	100
	90	70	118	20	M 12	912118BAZ	258,30	20	100
	90	70	128	30	M 12	912128BAZ	287,20	20	100
	90	70	148	50	M 12	912148BAZ	374,70	20	100
	90	70	163	65	M 12	912163BAZ	414,60	20	100
	90	70	178	80	M 12	912178BAZ	438,40	20	100
16	110	85	123	5	M 16	916123BAZ	462,30	10	50
	110	85	138	20	M 16	916138BAZ	518,40	10	50
	110	85	178	60	M 16	916178BAZ	685,70	10	50

BAZ Acero Inoxidable A4						Precios		Envase	Embalaje
Ø [mm]	h ₁ ≥ [mm]	h _{ef} ≥ [mm]	L [mm]	t _{fix} ≥ [mm]	Rosca	Código	Precio €/100 u.	(Uds.)	(Uds.)
8	60	45	72	10	M 8	9X872BAZ	537,80	50	250
	60	45	92	30	M 8	9X892BAZ	589,70	50	250
	60	45	112	50	M 8	9X8112BAZ	728,40	40	200
10	75	60	92	10	M 10	9X1092BAZ	702,60	40	200
	75	60	102	20	M 10	9X10102BAZ	745,90	25	125
	75	60	112	30	M 10	9X10112BAZ	858,80	25	125
	75	60	132	50	M 10	9X10132BAZ	997,50	25	125
12	90	70	103	5	M 12	9X12103BAZ	1058,10	20	100
	90	70	118	20	M 12	9X12118BAZ	1075,60	20	100
	90	70	128	30	M 12	9X12128BAZ	1162,20	20	100
	90	70	148	50	M 12	9X12148BAZ	1526,40	20	100
	90	70	163	65	M 12	9X12163BAZ	1595,90	20	100
16	110	85	123	5	M 16	9X16123BAZ	1747,80	10	50
	110	85	138	20	M 16	9X16138BAZ	2242,00	10	50
	110	85	168	50	M 16	9X16168BAZ	2549,60	10	50

BAZ HD Galvanizado en caliente						Precios		Envase	Embalaje
Ø [mm]	h ₁ ≥ [mm]	h _{ef} ≥ [mm]	L [mm]	t _{fix} ≥ [mm]	Rosca	Código	Precio €/100 u.	(Uds.)	(Uds.)
8	60	45	72	10	M 8	9HD872BAZ	135,60	50	250
	60	45	92	30	M 8	9HD892BAZ	167,50	50	250
	60	45	112	50	M 8	9HD8112BAZ	189,60	40	200
	60	45	147	85	M 8	9HD8147BAZ	229,60	40	200
10	75	60	92	10	M 10	9HD1092BAZ	207,30	40	200
	75	60	102	20	M 10	9HD10102BAZ	239,10	25	125
	75	60	112	30	M 10	9HD10112BAZ	271,10	25	125
	75	60	132	50	M 10	9HD10132BAZ	290,80	25	125
	75	60	162	80	M 10	9HD10162BAZ	315,80	25	125
12	90	70	103	5	M 12	9HD12103BAZ	294,80	20	100
	90	70	118	20	M 12	9HD12118BAZ	265,00	20	80
	90	70	128	30	M 12	9HD12128BAZ	366,90	20	100
	90	70	148	50	M 12	9HD12148BAZ	478,30	20	100
	90	70	163	65	M 12	9HD12163BAZ	497,30	20	100
	90	70	178	80	M 12	9HD12178BAZ	526,30	20	100
16	110	85	123	5	M 16	9HD16123BAZ	554,90	10	50
	110	85	138	20	M 16	9HD16138BAZ	621,90	10	50
	110	85	178	60	M 16	9HD16178BAZ	822,60	10	50

Datos instalación	Medidas				
BAZ Rosca	M 6*	M 8	M 10	M 12	M 16
Par de apriete T _{max} [Nm]	7	20/15**	35	50/70**	120
Llave de vaso SW	10	13	17	19	24
Diámetro agujero pieza a fijar d _i [mm]	7	9	12	14	18
Arandela -Ø x grosor [mm]	12 x 1,6	17 x 1,6	21 x 2,0	24 x 2,5	30 x 3,0

* No forma parte de la homologación.
 ** 20 por BAZ, BAZ HD, BAZ A4, 15 por BAZ HD.
 ** 50 por BAZ, BAZ HD, 70 por BAZ A4, BAZ HCR.

Distancias entre anclajes y al borde	Medidas				
BAZ Rosca		M8	M10	M12	M16
Distancia entre anclajes	S _{ca} [mm]	135	180	210	255
Distancia al borde	C _{ca} [mm]	68	90	105	128
Distancia mínima entre anclajes	S _{min} [mm]	50	55	60	70
	C _z [mm]	50	80	90	120
Distancia mínima al borde	C _{min} [mm]	50	50	55	85
	S _z [mm]	50	100	145	150
Espesor mínimo	h _{min} [mm]	100	120	140	170
Profundidad de anclaje efectiva	h _{ef} [mm]	45	60	70	85

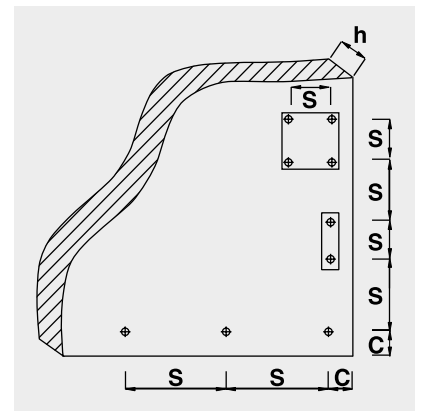

Cargas recomendadas N_{Per}

BAZ Rosca	M 8		M 10		M 12		M 16		
BAZ Denom.	BAZ gvz. BAZ HD	BAZ A4	BAZ gvz. BAZ HD	BAZ A4	BAZ gvz. BAZ HD	BAZ A4	BAZ gvz. BAZ HD	BAZ A4	
Carga admisible de un anclaje del centro al borde N _{Per} ^{1) 2)}									
En hormigón fisurado C20/25	N _{Per} [kN]	2,0	2,0	3,6	3,6	4,8	4,8	9,5	9,5
En hormigón no fisurado C20/25	N _{Per} [kN]	3,6	3,6	6,3	6,3	7,9	7,9	16,7	16,7

Carga lateral admisible de un anclaje del centro al borde V _{Per} ^{1) 2)}									
En hormigón fisurado C20/25	V _{Per} [kN]	5,2	5,2	10,3	9,7	13,1	14,3	25,1	26,9
En hormigón no fisurado C20/25	V _{Per} [kN]	5,7	6,3	10,3	9,7	13,1	14,3	25,1	26,9
Momento de flexión permitido M _{Per}	M _{Per} [Nm]	12,0	12,6	27,4	25,7	41,1	45,1	106,3	114,3

¹⁾ Según se observa en la homologación ETA-10/0280.
²⁾ Tiene en cuenta factores de seguridad especificados en la homologación, así como un factor de seguridad parcial de la acción de γF=1,4.
 Los valores indicados en el interespaciado de las fijaciones de refuerzo o separación es de S≥10 cm y el diámetro supone D≤10 mm.

Anclaje reforzado SLA



SLA S



SLA B espárrago



SLA C espárrago

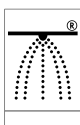

Características

- Anclaje altas cargas.
- Disponible con diversas cabezas.
- El anillo de plástico integrado impide el giro del anclaje y permite superar espacios entre la pieza sujeta y la superficie de hormigón.
- Marcación de profundidad de anclaje para la instalación rápida.
- Homologado opción 1 para hormigón fisurado y no fisurado.

Adecuado para materiales

- Hormigón

Cajas

SLA S Cincado						Precios		Envase	Embalaje
d ₀ [mm]	h ₁ ≥ [mm]	h _{eff} ≥ [mm]	L [mm]	t _{fix} ≥ [mm]	t _{ins} ≥ [Nm]	Código	Precio €/100 u.	(Uds.)	(Uds.)
12	85	59	80	10	M8	91280SLAS	343,00	30	150
	85	59	90	20	M8	91290SLAS	377,70	30	150
	85	59	120	50	M8	912120SLAS	432,30	25	125
15	95	67	90	10	M10	91590SLAS	472,20	20	100
	95	67	100	20	M10	915100SLAS	497,30	15	75
	95	67	130	50	M10	915130SLAS	568,00	15	75
18	115	88	110	10	M12	918110SLAS	727,60	10	50
	115	88	125	25	M12	918125SLAS	732,50	10	50
	115	88	150	50	M12	918150SLAS	864,60	5	25
24	130	99	125	10	M16	924125SLAS	1529,60	5	25
	130	99	140	25	M16	924140SLAS	1702,30	5	25
	130	99	165	50	M16	924165SLAS	1868,80	4	20

Con tornillo de cabeza hexagonal; calidad de acero S 8.8

SLA B Cincado						Precios		Envase	Embalaje
d ₀ [mm]	h ₁ ≥ [mm]	h _{eff} ≥ [mm]	L [mm]	t _{fix} ≥ [mm]	t _{ins} ≥ [Nm]	Código	Precio €/100 u.	(Uds.)	(Uds.)
12	85	59	80	10	M8	91280SLAB	351,50	30	150
	85	59	90	20	M8	91290SLAB	389,30	30	150
	85	59	120	50	M8	912120SLAB	454,50	25	125
15	95	67	90	10	M10	91590SLAB	487,90	20	100
	95	67	100	20	M10	915100SLAB	508,10	15	75
	95	67	130	50	M10	915130SLAB	568,80	15	75
18	115	88	110	10	M12	918180SLAB	757,00	10	50
	115	88	125	25	M12	918110SLAB	737,90	10	50
	115	88	150	50	M12	918125SLAB	751,50	10	50
24	130	99	125	10	M16	918150SLAB	911,20	5	25
	130	99	140	25	M16	918200SLAB	1127,10	5	25
	130	99	165	50	M16	924125SLAB	1725,70	5	25
130	99	140	25	M16	924140SLAB	1971,10	5	25	
	99	165	50	M16	924165SLAB	2060,50	4	20	
	99	215	100	M16	924215SLAB	2461,80	4	-	

Con perno, calidad de acero S 8.8

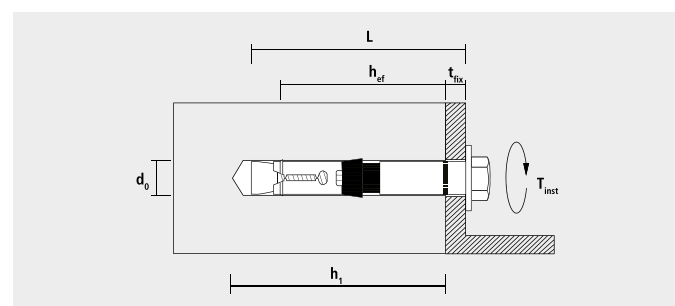

Instalación

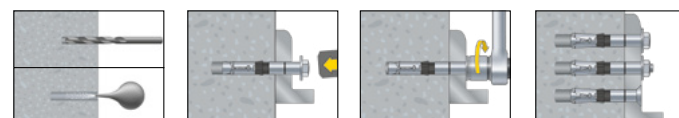

SLA C Cincado						Precios		Envase	Embalaje
d ₀ [mm]	h ₁ ≥ [mm]	h _{eff} ≥ [mm]	L [mm]	t _{fix} ≥ [mm]	t _{ins} ≥ [Nm]	Código	Precio €/100 u.	(Uds.)	(Uds.)
12	85	59	80	16	M8	91280SLAC	372,40	30	150
	85	59	90	26	M8	91290SLAC	426,80	30	150
	85	59	120	56	M8	912120SLAC	518,70	25	125
15	95	67	90	17	M10	91590SLAC	526,40	20	100
	95	67	100	27	M10	915100SLAC	591,20	15	75

Con tornillo de cabeza avellanada; calidad de acero S 8.8

Datos instalación	Medidas			
	M8	M10	M12	M16
SLA S/B/C				
Par de apriete T _{inst} [Nm]	20	45	80	150
SLA S/B entre caras SW [mm]	13	17	19	24
SLA C hexágono interno [mm]	6	8	-	-
Ø diámetro agujero pieza a fijar d _i [mm]	14	17	20	26

Cargas, espaciado y distancia al borde										
Tipo	Rosca	Hormigón fisurado ^(1,2) C20/25		Hormigón no fisurado ^(1,2) C20/25		Momento flector permitido M _{per} [Nm]	Espaciado		Distancia de bordes	
		Tensión N _{per} [kN]	Cizallamiento V _{per} [kN]	Tensión N _{per} [kN]	Cizallamiento V _{per} [kN]		S _{cr} [mm]	S _{min} [mm]	C _{cr} [mm]	C _{min} [mm]
SLA 12	M8	5,7	7,8	10,9	10,9	17	177	60	89	60
SLA 15	M10	7,6	18,8	13,2	24,0	34	201	70	101	70
SLA 18	M12	11,9	28,3	19,8	28,6	60	264	80	132	80
SLA 24	M16	16,9	33,8	23,6	47,4	152	297	100	149	100

¹⁾ Cargas permitidas para anclaje individual sin influencia de espaciado y distancia de bordes.
²⁾ Los valores de carga incluyen los factores de seguridad parciales de las resistencias según la aprobación y un factor de seguridad parcial en acción de V_f = 1.4.
 Para fuerzas de hormigón superiores, los valores N_{per} se incrementan en un máx. 55% (N_{per, C50/60} = 1,55 x N_{per, C20/25}).
 Si se queda por debajo de la zona carbonizada, espacio o distancia de borde (C_{cr} or S_{cr}) las cargas se deben reducir. h_{min}, S_{min} y C_{min} no deben estar por debajo de los valores mínimos indicados.

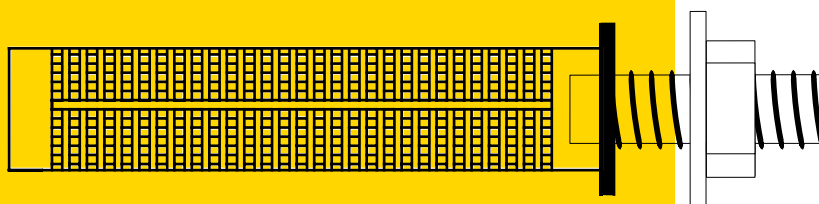

Anclajes químicos

ResiFIX® PY -Polyester-	95
ResiFIX® EY -Epoxy-	96
ResiFIX® VY -Vinylester-	96
ResiFIX® VY -Vinylester ECO	97
RESI AST	103
Tamiz plástico SH	104
Tamiz metálico TMR	104
Manguito rosca interior IGH	105
Mezclador MR	105
Bomba soplante BOP y escobilla PLRBK	105
Pistolas de inyección	106
ResiTHERM® S	107
ResiTHERM®	109
Cápsula química VA	113
Espárrago roscado VA AST	114

Elección del sistema apropiado para cualquier instalador

ResiFIX	Vynilester			Vynilester ECO	Epoxy			Polyester			
Comparativa de resinas	300VSF	410VYSF	300VCSF	300VY ECOSF	300EYSF	410EYSF	410EY	300PSF	410PYSF	300CR	410CR
Contenido [ml]	280	410	300	300	280	410	410	300	410	300	410
Cánula											
Tipo de cartucho	Coaxial	Coaxial	Bolsa	Bolsa	Coaxial	Coaxial	Coaxial	Bolsa	Coaxial	Bolsa	Coaxial
Caducidad [meses]	18	18	12	12	18	18	18	12	18	12	12
Varilla roscada	Acero 4.6, 5.8, 8.8 Acero inoxidable			Acero 45.6, 5.8, 8.8 Acero inoxidable	Acero 4.6, 5.8, 8.8 Acero inoxidable			Acero 4.6, 5.8, 8.8 Acero inoxidable			
Varilla coarugada	✓			✓ [Sólo opción 7]	✗			✗			
Opción 1 Hormigón fisurado [opción 1]					✗			✗			
Opción 7 Hormigón no fisurado [opción 7]											
Varilla Homologación varilla coarugada				✗	✗			✗			
Albañilería Homologado en albañilería								✗			
F 120 Homologado fuego [F120]				✗	✗			✗			
FIXING seismic Homologación sísmica					✗			✗			
Emisiones espacios cerrados	✓			✓	✓ ✗			✓ ✗			
Libre de estireno	✓			✓	✓ ✗			✓ ✗			
Cargas hormigón no fisurado C20/25 M10-90)											
Cargas ladrillo hueco HLZ 12 (M10-130)											
Agujero mojado	✓			✓	✓			✓			
Agujero inundado	✓			✓	✓			✓			
Apto contacto con agua potable	✓			✗	✗			✗			
Temp. mín. hormigón	≥ -10°C ≥ -10°C ≥ -20°C			≥ -5°C	≥ -10°C ≥ -5°C			≥ -10°C ≥ -5°C			
Temp. después de instalación	-40°C a +120°C			-40°C a +80°C	-40°C a +80°C			-40°C a +80°C			
Resistencia a químicos	Alto			Alto	Alto			Alto			
Olor	Fuerte			Medio	Medio Fuerte			Medio Fuerte			

ResiFIX® PY -Polyester-





FIJACIÓN



Características

- Se puede fijar en agujeros mojados.
- 12 meses caducidad.
- Resiste temperaturas entre -40°C y +80°C .
- Formato PY 300SF con dos cánulas.

PY Polyester con estireno		Precios		Embalaje
Denom.	Código	Precio €/u.		 (Uds.)
PY300	300CR	14,50		12
PY410	410CR	17,10		12

PY Polyester sin estireno		Precios		Embalaje
Denom.	Código	Precio €/u.		 (Uds.)
PY300SF	300PSF+	17,50		12
PY410SF	410PYSF	23,80		12

* Con 2 cánulas.

ResiFIX® EY -Epoxy-



EY410 EY300SF EY410SF

**Recomendado
Multimaterial**



M10-90
C20/25



Características

- Fragua en presencia de humedad.
- Buena resistencia a agentes químicos.
- 18 meses caducidad.
- Formato EY 300SF con dos cánulas.
- Resina indicada para cualquier tipo de material (hueco y macizo).

EY Epoxy con estireno	Precios		Embalaje
Denom.	Código	Precio €/u.	(Uds.)
EY410	410EY	20,00	12

EY Epoxy sin estireno	Precios		Embalaje
Denom.	Código	Precio €/u.	(Uds.)
EY300SF	300EYSF+	18,80	12
EY410SF	410EYSF	25,00	12

* Con 2 cánulas

ResiFIX® VY -Vinylester-



VY300SF VY410SF

**Recomendado
Altas cargas**



M10-90mm
C20/25



Características

- Sin estireno.
- Resistente al fuego.
- Homologación CE en hormigón.
- Homologación Dibt en hueco.
- Fragua incluso en agua.
- Fijación idónea para elementos vibrantes.
- 18 meses caducidad.
- Resina indicada para hormigón macizo y grandes cargas.
- Coarrugados.

VY Vinylester sin estireno	Precios		Embalaje
Denom.	Código	Precio €/u.	(Uds.)
VY300SF	300VSF+	23,80	12
VY410SF	410VYSF	30,00	12

* Con 2 cánulas

ResiFIX® VY ECO



300VYECOSF



FIJACIÓN

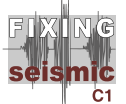

Características

- Sin estireno.
- Homologación CE en hormigón fisurado y no fisurado.
- Homologación CE en hueco.
- Homologación sísmica.
- Formato bolsa 12 meses de caducidad.
- Fragua en presencia de humedad y en agujeros inundados.

VY Vinylester eco sin estireno	Precios		Embalaje
Denom.	Código	Precio €/u.	 (Uds.)
VY ECO 300 ml	300VYECOSF+	19,00	12

* Formato bolsa.

ResiFIX® datos técnicos en albañilería

Fijación en albañilería con ResiFIX PY y PY SF

Permisible F_{per} y cargas recomendadas F_{recen} [kN] para todas las direcciones, parámetros de instalación y unidades.

Espárragos RESI AST, VA AST		M8	M10	M12	M16
Fijación en ladrillo macizo (sin tamiz)					
Ladrillo macizo de arcilla	Mz 12 [kN]	1,7	1,7	1,7	1,7
Ladrillo macizo silicocalcáneo	KS 12 [kN]	1,7	1,7	1,7	1,7
Diámetro del agujero \varnothing	d_0 [mm]	10	12	14	18
Profundidad del agujero	h_0 [mm]	85	95	115	130
Profundidad efectiva	h_{ef} [mm]	80	90	110	125

Fijación en ladrillo hueco (con tamiz)		SH 13-100	SH 15-100	SH 15-130	SH 20-85	SH 20-85
Tamiz						
Ladrillo macizo de arcilla	HLz 4 [kN]	0,3 (0,6)	0,3 (0,6)	0,3 (0,6)	0,3 (0,6)	0,3 (0,6)
	HLz 6 [kN]	0,4 (0,8)	0,4 (0,8)	0,4 (0,8)	0,4 (0,8)	0,4 (0,8)
	HLz 12 [kN]	0,8 (1,0)	0,8 (1,0)	0,8 (1,0)	0,8 (1,0)	0,8 (1,0)
Ladrillo macizo silicocalcáneo	KSL 4 [kN]	0,4 (0,6)	0,4 (0,6)	0,4 (0,6)	0,4 (0,6)	0,4 (0,6)
	KSL 6 [kN]	0,6 (0,8)	0,6 (0,8)	0,6 (0,8)	0,6 (0,8)	0,6 (0,8)
	KSL 12 [kN]	0,8 (1,4)	0,8 (1,4)	0,8 (1,4)	0,8 (1,4)	0,8 (1,4)
Bloque de hormigón ligero	Hbl 2 [kN]	0,3 (0,6)	0,3 (0,6)	0,3 (0,6)	0,3 (0,6)	0,3 (0,6)
	Hbl 4 [kN]	0,6 (0,8)	0,6 (0,8)	0,6 (0,8)	0,6 (0,8)	0,6 (0,8)
Bloque hueco de hormigón	Hbn 4 [kN]	0,6 (0,8)	0,6 (0,8)	0,6 (0,8)	0,6 (0,8)	0,6 (0,8)
Diámetro del agujero \varnothing	d_0 [mm]	14	16	16	20	20
Profundidad de taladro	h_0 [mm]	105	105	135	90	90
Profundidad efectiva	h_{ef} [mm]	80	90	130	85	85
Momento de flexión (Cincado 5.8)	M_{per} [Nm]	10,7	21,4	37,4		94,9
Momento de flexión (Acero inox A4)	M_{per} [Nm]	12,1	24,1	42,1		104,2

Distancia entre anclajes y borde					
Distancia entre anclajes (grupo de anclajes)	$a \geq$ [mm]	100 (Hbl y Hbn = 200)			
Mínima distancia entre anclajes	mín. [mm]	50 (Hbl y Hbn = 200)			
Distancia entre anclajes (anclaje único)	a_z [mm]	250			
Distancia al borde	$a_e \geq$ [mm]	200 para ladrillos huecos, 250 para ladrillos macizos			
Distancia al borde para aplicaciones especiales	$a_e \geq$ [mm]	50 para los ladrillos huecos, 60 para ladrillos macizos			
Mín. espesor del material base (albañilería)	h_{min} [mm]	110			
Diámetro del taladro de la pieza a fijar	d_f [mm]	9	12	14	18
Par de instalación	$T_{inst} \leq$ [mm]	2	2	8	8



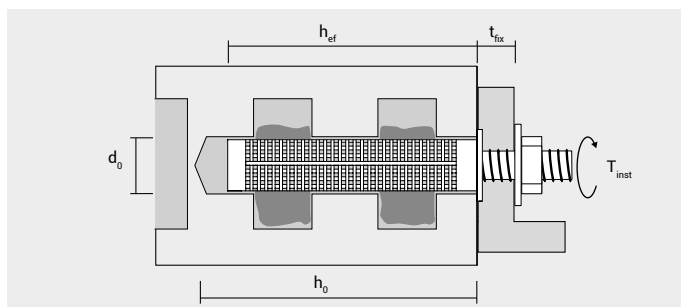
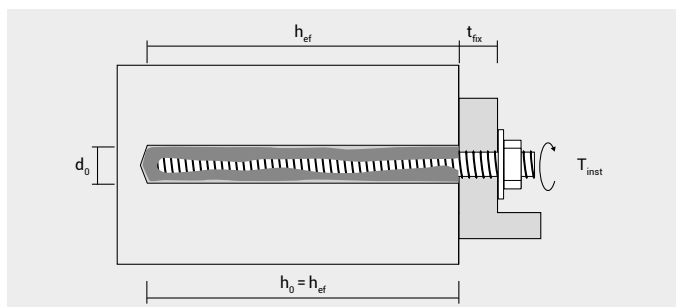

Los valores de carga: Cuando el anclaje en albañilería es hueco o perforado los valores entre paréntesis se pueden utilizar si el agujero se hace con un taladro giratorio (martillo apagado). Para KSL la pared exterior debe ser como mínimo de 30 mm.



ResiFIX® datos técnicos en albañilería

Fijación en albañilería con Epoxy EYSF

Cargas recomendadas en [kN], parámetros de instalación y unidades dimensionales.

Fijación en ladrillo macizo y hueco (con y sin tamiz)								
Materiales	Densidad ρ [kg/dm ³]	Resist. compres. fb [N/mm ²]	Espárrago RESI AST, VA AST Medida	Tamiz Medida	Empotr. Mínimo h_{ef} mm	Categoría usomojado 24°C/40°C ¹⁾		
						N_{per} [kN]	V_{per} [kN]	
Ladrillo macizo silicocalcáreo KSV		$\geq 2,0$	≥ 20	M8	-	80	0,9	0,9
				M10	-	90	0,9	0,9
				M12	-	100	0,7	0,7
				M16	-	100	1,3	1,3
Ladrillo macizo MZ		$\geq 1,8$	≥ 20	M8	-	80	1,7	1,1
				M10	-	90	1,7	1,0
				M12	-	100	2,0	1,4
				M16	-	100	1,7	1,4
Ladrillo hueco silicocalcáreo KSL (KSL-R 16 DF)		$\geq 1,4$	≥ 12	M8	SH 12-80	80	0,4	0,4
				M10	SH 15-85	85	0,6	0,6
				M10	SH 15-130	130	0,9	0,7
				M12	SH 20-85	85	1,0	0,7
Ladrillo hueco HLz (HLz 16DF)		$\geq 0,9$	≥ 12	M8	SH 12-80	80	1,0	0,7
				M10	SH 15-85	85	0,9	0,7
				M10	SH 15-130	130	1,3	0,7
				M12	SH 20-85	85	0,9	0,7
Ladrillo hueco (Bloc creux B40)		$\geq 1,0$	≥ 12	M8	SH 12-80	80	0,1	0,1
				M10	SH 15-85	85	0,1	0,1
				M10	SH 15-130	130	0,5	0,5
				M12	SH 20-85	85	0,3	0,3
				M16	SH 20-85	85	0,2	0,2

La pared exterior del KSL debe ser como mínimo de 30 mm

¹⁾Máxima temperatura continua / máxima temperatura puntual. La máxima temperatura continua es significativamente constante en el tiempo. La máxima temperatura puntual es aquella que ocurre en periodos breves de tiempo.

Distancia entre fijaciones y al borde					
Materiales	Medida	Tamiz	Distancia min. borde $c_{min} = c_{cr}$ [mm]	Distancia min. entre anclajes paralelo a la junta $s_{min, } = s_{cr, }$ [mm]	Distancia min. entre anclajes perpendicular a la junta $s_{min,\perp} = s_{cr,\perp}$ [mm]
Ladrillo macizo silicocalcáreo KSV	M8	-	120	240	240
	M10	-	135	270	270
	M12	-	150	300	300
	M16	-	150	300	300
Ladrillo macizo MZ	M8	-	120	240	240
	M10	-	135	270	270
	M12	-	150	300	300
	M16	-	150	300	300
Ladrillo hueco silicocalcáreo KSL (KSL-R 16 DF)	M8	SH 12-80	100	497	113
	M10	SH 15-85	100	240	113
	M10	SH 15-130	100	497	238
	M12,M16	SH 20-85	120	240	113
Ladrillo hueco HLz (HLz 16DF)	M8	SH 12-80	100	240	113
	M10	SH 15-85	100	240	113
	M10	SH 15-130	100	240	113
	M12,M16	SH 20-85	120	240	113
Ladrillo hueco (Bloc creux B40)	M8	SH 12-80	100	500	200
	M10	SH 15-85	100	500	200
	M10	SH 15-130	100	500	200
	M12,M16	SH 20-85	120	500	200



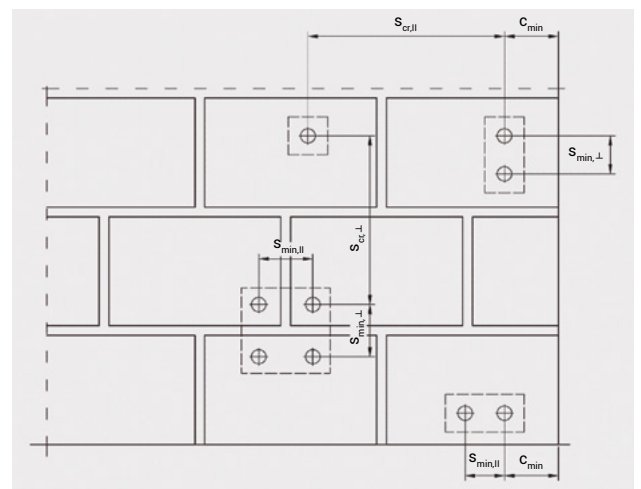



Momento flexión						
Acero			Medida espárrago			
			M8	M10	M12	M16
Cincado 5.8	M_{per}	[Nm]	10,8	21,2	37,7	94,8
Inoxidable A4	M_{per}	[Nm]	11,9	23,8	42,1	106,7



ResiFIX® datos técnicos en albañilería

Fijación en albañilería con Vinylster VYSF

Cargas recomendadas en [kN], parámetros de instalación y unidades dimensionales.

Materiales		Densidad ρ [kg/dm ³]	Resist. compres. fb [N/mm ²]	Espárrago RESI AST, VA AST Medida	Tamiz Medida	Empotr. Mínimo h _{ef} [mm]	Categoría uso							
							Seco				Mojado			
							24°C/40°C ¹⁾		50°C/80°C ¹⁾		24°C/40°C ¹⁾		50°C/80°C ¹⁾	
							N _{per} [kN]	V _{per} [kN]	N _{per} [kN]	V _{per} [kN]	N _{per} [kN]	V _{per} [kN]	N _{per} [kN]	V _{per} [kN]
Ladrillo macizo silicocalcáreo KSV		≥ 1,8	≥ 8	M8	-	80	1,1	1,1	0,9	0,9	0,9	0,9	0,7	0,7
				M10	-	90	1,4	1,4	1,3	1,3	1,1	1,1	1,0	1,0
Ladrillo macizo MZ		≥ 1,8	≥ 12	M8	-	80	1,1	1,1	0,9	0,9	1,0	1,0	0,9	0,9
				M10	-	90	1,4	1,4	1,3	1,3	1,4	1,4	1,1	1,1
Ladrillo hueco silicocalcáreo KSL (KSL-R 16 DF)		≥ 1,2	≥ 12	M8	SH 13-100	80	1,0	0,7	1,0	0,7	0,9	0,6	0,9	0,6
Ladrillo hueco silicocalcáreo KSL (KSL 16 DF)		≥ 1,2	≥ 12	M8	SH 13-100	80	0,7	0,6	0,7	0,6	0,6	0,4	0,6	0,4
				M10	SH 15-100	90	0,9	0,7	0,9	0,7	0,6	0,6	0,6	0,6
Ladrillo hueco HLZ Poroton (≥2DF acc. Z-17.1-383)		≥ 0,8	≥ 12	M8	SH 13-100	80	0,6	0,6	0,6	0,6	0,6	0,6	0,6	0,6
				M10	SH 15-100	90	0,6	0,7	0,6	0,7	0,6	0,7	0,6	0,6
Ladrillo hueco HLZ (HLZ 16DF)		≥ 0,9	≥ 12	M8	SH 13-100	80	0,9	0,6	0,9	0,6	0,7	0,6	0,7	0,6

Las cargas recomendadas para M10 también lo son para M12 y M16. La pared exterior del KSA debe ser como mínimo de 30 mm.

¹⁾Máxima temperatura continua / máxima temperatura puntual. La máxima temperatura continua es significativamente constante en el tiempo. La máxima temperatura puntual es aquella que ocurre en periodos breves de tiempo.

Distancia entre fijaciones y al borde					
Materiales	Medida	Tamiz	Distancia min. borde c _{min} = c _{cr} [mm]	Distancia min. entre anclajes paralelo a la junta s _{min,} = s _{cr,} [mm]	Distancia min. entre anclajes perpendicular a la junta s _{min,⊥} = s _{cr,⊥} [mm]
	M10	-	135	270	270
Ladrillo macizo MZ	M8	-	120	240	240
	M10	-	135	270	270
Ladrillo hueco silicocalcáreo KSL (KSL-R 16DF)	M8	SH 13-100	100	498	248
	M10	SH 15-100	100	498	248
Ladrillo hueco silicocalcáreo KSL (KSL 16DF)	M8	SH 13-100	100	498	238
	M10	SH 15-100	100	498	238
Ladrillo hueco HLZ Poroton (≥2DF acc. Z-17.1-383)	M8	SH 13-100	100	373	238
	M10	SH 15-100	100	373	238
Ladrillo hueco HLZ (HLZ 16DF)	M8	SH 13-100	100	373	238
	M10	SH 15-100	100	373	238

Momento flexión				
Acero	M _{Per}	[Nm]	Medida espárrago	
			M8	M10
Cincado 5.8	M _{Per}	[Nm]	10,8	21,2
Inoxidable A4	M _{Per}	[Nm]	11,9	23,8

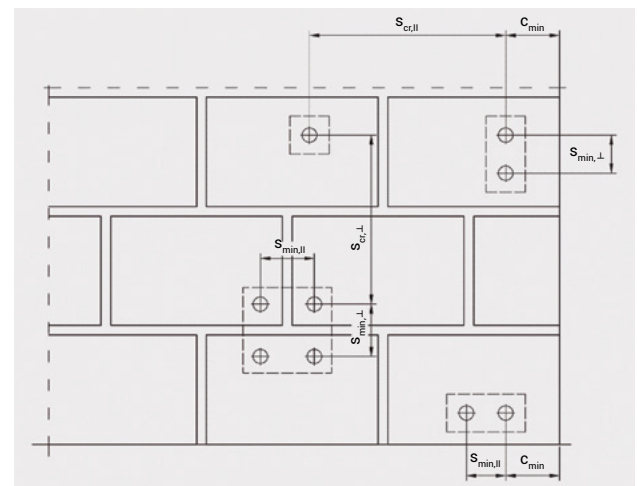

ResiFIX® datos técnicos

Fijación en hormigón con Epoxyacrylate ResiFIX EY SF

Cargas recomendadas F_{per} in [kN] en Hormigón no fisurado C20/25 para un anclaje único sin influencia de distancias a otros anclajes o al borde, parámetros de instalación y magnitud de las unidades. Incluye todos los factores de seguridad según ETAG 001 (γ_M und γ_c). Consulte la homologación ETA-12/0107 para el diseño y los cálculos.

Espárragos RESI AST, VA AST		M8	M10	M12	M16	M20	M24
Agujero \emptyset	d_0 [mm]	10	12	14	18	24	28
Empotramiento	h_{ef} [mm]	80	90	110	125	170	210
Carga de tensión ¹⁾ (24 °C / 40 °C) ²⁾							
Cincado 5.8	N_{Per} [kN]	6,3	12,8	13,9	19,8	29,8	37,7
Acero inox A4	N_{Per} [kN]	6,3	12,8	13,9	19,8	29,8	37,7
Carga cizalla ¹⁾ (24 °C / 40 °C) ³⁾							
Cincado 5.8	V_{Per} [kN]	5,1	8,6	12,0	22,3	34,9	50,3
Acero inox. A4	V_{Per} [kN]	6,0	9,2	13,7	25,2	39,4	56,8
Momento de flexión (Cincado 5.8)	M_{Per} [Nm]	10,9	21,1	37,7	94,9	185,7	320,6
Momento de flexión (Acero inox A4)	M_{Per} [Nm]	11,9	23,8	42,1	106,7	207,9	359,9
Distancia entre anclajes y borde							
Distancia entre anclajes	$s_{cr,N}$ [mm]	160	180	220	250	340	420
Distancia al borde	$c_{cr,N}$ [mm]	80	90	110	125	170	210
Mín. distancia entre anclajes	s_{min} [mm]	40	50	60	80	100	120
Mínima distancia al borde	c_{min} [mm]	40	50	60	80	100	120
Mínimo espesor de hormigón	h_{min} [mm]	110	120	140	160	215	260
Par de instalación	$T_{inst} \leq$ [Nm]	10	20	40	60	120	150

¹⁾ Factores de incremento para hormigón no fisurado C30/37 = 1,08, C40/50 = 1,15, C50/60 = 1,19 .

²⁾ Máx. temperatura continua / máx. temperatura puntual después de la instalación.

Fijación en hormigón con ResiFIX PY y PY SF

Cargas recomendadas $F_{rec in}$ [kN] en hormigón no fisurado C20/25 para un anclaje único sin influencia de distancias a otros anclajes o al borde. Los factores de seguridad están incluidos.

Anclaje		M8	M10	M12	M16	M20
Profundidad efectiva	h_{ef} [mm]	80	90	110	125	170
Distancia al borde	$c_{cr,N}$ [mm]			$1,5 \times h_{ef}$		
Distancia entre anclajes	$s_{cr,N}$ [mm]			$3,0 \times h_{ef}$		
Carga de tracción recomendada 50 °C / 80 °C ¹⁾	N_{rec} [kN]	4,5	6,9	9,6	10,8	18,1
Carga cizalla recomendada sin brazo de palanca para el acero 5.8 2)	V_{rec} [kN]	5,1	8,6	12,0	22,3	34,9

¹⁾ Máx. temperatura continua / máx. temperatura puntual. La temperatura continua del hormigón es bastante constante en el tiempo.

Las temperaturas puntuales son aquellas que suceden en intervalos, por ejemplo, resultado de todo un día o de la tarde.

²⁾ Carga a cizalla con brazo de palanca según anexo C de la ETAG 001.

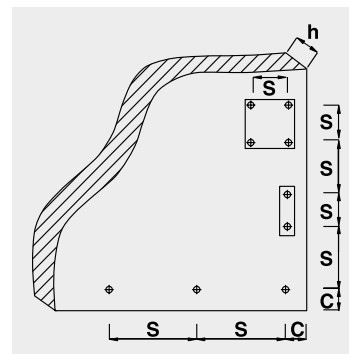
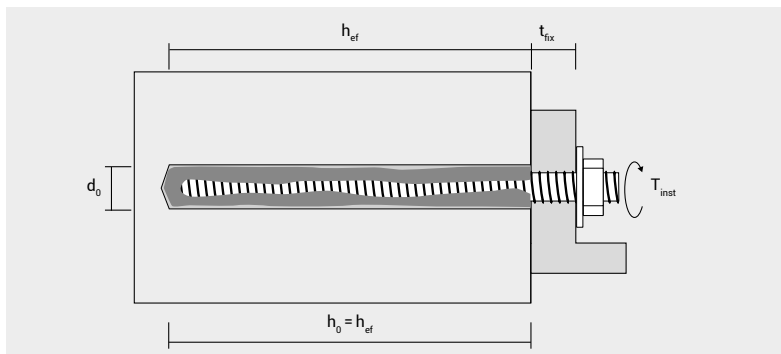

ResiFIX® datos técnicos

Fijación en hormigón con el sistema profesional ResiFIX VY SF

Cargas recomendadas F_{Per} en [kN] en hormigón no fisurado (Opción 7) hormigón C20/25 y hormigón fisurado (Option 1) hormigón C20/25 para un anclaje único sin influencia de distancias a otros anclajes o al borde, parámetros de instalación y magnitud de las unidades. Incluye todos los factores de seguridad según ETAG 001 (V_M y V_F). Diseño según TR029. Consulta la homologación ETA-10/0134 para el diseño y los cálculos.

Espárragos RESI AST, VA AST			M8	M10	M12	M16	M20	M24	M30	
Agujero Ø	d_0	[mm]	10	12	14	18	24	28	35	
Empotramiento $h_{ef,min} / h_{ef,stand} / h_{ef,max}$		[mm]	60 / 80 / 160	60 / 90 / 200	70 / 110 / 240	80 / 125 / 320	90 / 170 / 400	96 / 210 / 480	120 / 280 / 600	
Carga de tensión ^{1) 2) (24 °C / 40 °C) ³⁾ hormigón no fisurado}										
Cincado 5.8	N_{Per}	[kN]	7,2 / 8,6 / 8,6	9,0 / 13,5 / 13,8	11,7 / 19,7 / 20,0	14,3 / 28,0 / 37,6	17,1 / 44,4 / 58,6	18,8 / 61,0 / 83,8	26,3 / 94,0 / 133,3	
Acero inox A4	N_{Per}	[kN]	7,2 / 9,6 / 9,9	9,0 / 13,5 / 15,7	11,7 / 19,7 / 22,5	14,3 / 28,0 / 42,0	17,1 / 44,4 / 65,3	18,8 / 61,0 / 94,3	26,3 / 70,2 / 70,2	
Carga de tensión ^{1) 2) (24 °C / 40 °C) ³⁾ hormigón fisurado}										
Cincado 5.8	N_{Per}	[kN]	-	-	5,8 / 9,1 / 19,7	8,8 / 13,7 / 35,1	12,3 / 23,3 / 54,9	15,8 / 34,6 / 79,0	26,3 / 68,1 / 133,3	
Acero inox A4	N_{Per}	[kN]	-	-	5,8 / 9,1 / 19,7	8,8 / 13,7 / 35,1	12,3 / 23,3 / 54,9	15,8 / 34,6 / 79,0	26,3 / 68,1 / 70,2	
Carga de tensión ^{1) 2) (50 °C / 80 °C) ³⁾ hormigón no fisurado}										
Cincado 5.8	N_{Per}	[kN]	5,4 / 7,2 / 8,6	6,7 / 10,1 / 13,8	9,4 / 14,8 / 20,0	14,3 / 22,4 / 37,6	17,1 / 38,1 / 58,6	18,8 / 53,4 / 83,8	26,3 / 68,1 / 133,3	
Acero inox A4	N_{Per}	[kN]	5,4 / 7,2 / 9,9	6,7 / 10,1 / 15,7	9,4 / 14,8 / 22,5	14,3 / 22,4 / 42,0	17,1 / 38,1 / 65,3	18,8 / 53,4 / 94,3	26,3 / 68,1 / 70,2	
Carga de tensión ^{1) 2) (50 °C / 80 °C) ³⁾ hormigón fisurado}										
Cincado 5.8	N_{Per}	[kN]	-	-	4,2 / 6,6 / 14,4	6,4 / 10,0 / 25,5	9,0 / 17,0 / 39,9	11,5 / 25,1 / 57,4	20,2 / 47,1 / 101,0	
Acero inox A4	N_{Per}	[kN]	-	-	4,2 / 6,6 / 14,4	6,4 / 10,0 / 25,5	9,0 / 17,0 / 39,9	11,5 / 25,1 / 57,4	20,2 / 47,1 / 70,2	
Carga cizalla ^{1) (24 °C / 40 °C, 50 °C / 80 °C) ³⁾ hormigón fisurado y hormigón no fisurado}										
Cincado 5.8	V_{Per}	[kN]	5,1 / 5,1 / 5,1	7,2 / 8,3 / 8,3	9,4 / 12,0 / 12,0	11,9 / 22,6 / 22,6	14,7 / 35,1 / 35,1	16,6 / 50,3 / 50,3	24,0 / 66,1 / 80,0	
Acero ino. A4	V_{Per}	[kN]	6,0 / 6,0 / 6,0	7,7 / 9,2 / 9,2	9,9 / 13,7 / 13,7	12,6 / 24,7 / 25,2	15,6 / 39,4 / 39,4	17,6 / 56,8 / 56,8	25,5 / 42,0 / 42,0	
Momento de flexión (Cincado 5.8)	M_{Per}	[Nm]	10,9	21,1	37,1	94,9	185,1	320,0	641,7	
Momento de flexión (Acero inox A4)	M_{Per}	[Nm]	11,9	23,8	42,1	106,2	207,9	359,0	337,6	
Distancia entre anclajes y borde										
Distancia entre anclajes ⁴⁾	$s_{cr,N}$	[mm]	185	253	304	375	506	581	657	
Distancia al borde ⁴⁾	$c_{cr,N}$	[mm]	92	126	152	188	253	291	329	
Mínima distancia entre anclajes	s_{min}	[mm]	40	50	60	80	100	120	150	
Mínima distancia al borde	c_{min}	[mm]	40	50	60	80	100	120	150	
Mínimo espesor de hormigón	h_{min}	[mm]	$h_{ef} + 30 \text{ mm} \geq 100 \text{ mm}$				$h_{ef} + 2d_0$			
Par de instalación	$T_{inst} \leq$	[mm]	10	20	40	80	120	160	200	

¹⁾ Valores válidos para $h_{ef,min} / h_{ef,stand} / h_{ef,max}$

²⁾ Factores de incremento para hormigón no fisurado C30/37 = 1,04, C40/50 = 1,08, C50/60 = 1,10.

³⁾ Máx. temperatura continua / máx. temperatura puntual después de la instalación. Para el rango de temperatura 72°C/120°C consulte la homologación ETA-10/0134.

⁴⁾ Depende de h_{ef} . Valores válidos para $h_{ef,stand}$

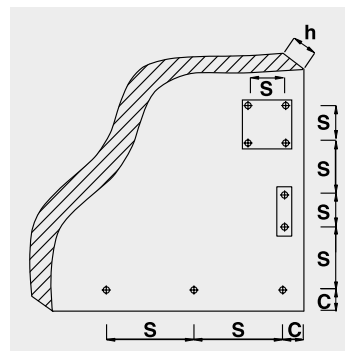
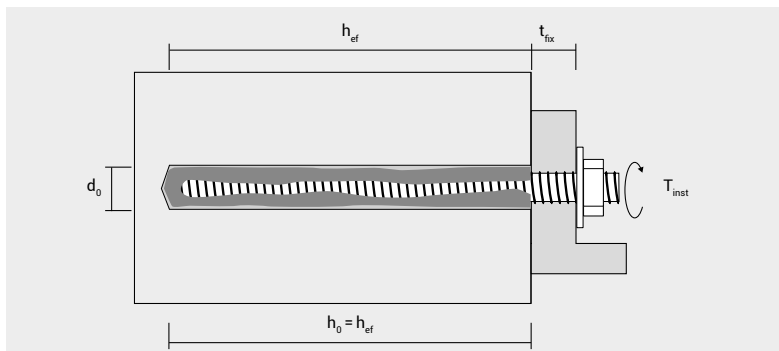

Accesorios ResiFIX® para material macizo RESI AST



Sistema de aplicación para material macizo



Fijación de barras corrugado



Fijaciones pesadas cerca de bordes



Fijaciones con alta resistencia a vibraciones



Fijación de mobiliario urbano

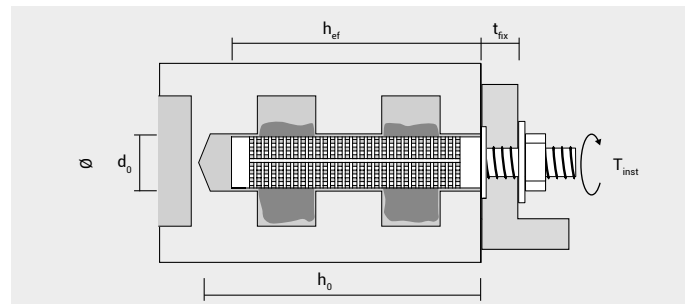
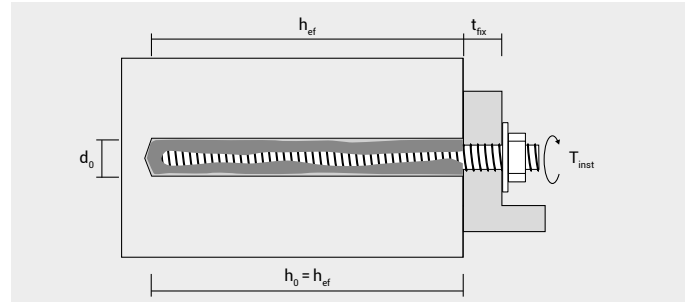

RESI AST Cincado con tuerca y arandela		Precios		Envase	Embalaje
Ø [mm]	t _{fix} [mm]	Código	Precio €/100 u.	(Uds.)	(Uds.)
10	20	98110RAST	143,60	10	100
10	40	98130RAST	185,40	10	100
12	10	910110RAST	159,80	10	100
12	30	910130RAST	191,50	10	100
12	70	910170RAST	246,10	10	100
12	100	910200RAST	274,20	10	60
14	5	912130RAST	218,60	10	100
14	35	912160RAST	264,60	10	100
14	85	912210RAST	353,50	10	60
18	15	916160RAST	435,60	10	60
18	45	916190RAST	493,70	10	60

RESI AST Inoxidable A4 con tuerca y arandela					Precios		Envase	Embalaje				
Ø [mm]	h _{ef, min} [mm]	t _{fix} h _{ef, min} [mm]	h _{ef, stand (1)} [mm]	t _{fix} h _{ef, Stand} [mm]	Ladrillo macizo		Ladrillo perforado		Código	Precio €/100 u.	(Uds.)	(Uds.)
					d ₀ -h ₀ [mm]	t _{fix} [mm]	Manguito [mm]	t _{fix} [mm]				
10	60	40	80	20	10-85	20	SH 12-80	20	9X8110RAST	535,20	10	100
10	60	60	80	40	10-85	40	SH 12-80	40	9X8130RAST	622,40	10	100
12	60	40	90	10	12-95	10	SH 16-85	10	9X10110RAST	681,30	10	100
12	60	60	90	30	12-95	30	SH 16-85	30	9X10130RAST	902,60	10	100

Accesorios ResiFIX® para material hueco

Tamiz plástico SH

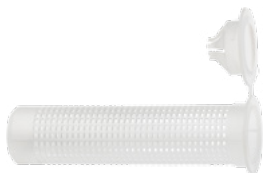

SH		Precios		Envase	Embalaje
∅ [mm]	∅ Espárrago	Código	Precio €/100 u.	(Uds.)	(Uds.)
13	M6-M8	91260SH	63,30	24	432
13	M6-M8	91280SH	67,90	24	432
16	M8- M10	91585SH	65,40	12	216
16	M8- M10	915130SH	98,90	12	144
20	M12-M16	92085SH	91,80	12	216
20	M12-M16	920130SH	182,00	20	160
20	M12-M16	920200SH	219,10	20	160

Sistema de aplicación para material hueco



Exteriores de vivienda. Siempre con tamiz



Fijaciones de toldos



Interiores de vivienda



Fijación en naves industriales y parkings

Tamiz metálico TMR



Características

- Para fijaciones químicas de gran longitud.
- Se puede cortar a medida (1 m).

TMR		Precios		Embalaje
∅ [mm]	∅ Espárrago	Código	Precio €/100 u.	(Uds.)
12	M6-M8	12TMRMEA	1388,90	10
16	M8-M12	16TMRMEA	1567,20	10



Accesorios ResiFIX®

Manguito rosca interior IGH



Características

- Acero cincado.
- Tapón de protección que evita la inserción de la resina en la rosca.
- Moleteado exterior para un mejor agarre.
- Longitud de rosca interna 26 mm

IGH					Precios		Envase	Embalaje
Ø [mm]	L [mm]	h _{nom} [mm]	Tamiz Adecuado [mm]	Rosca	Código	Precio €/100 u.	 (Uds.)	 (Uds.)
14	26	90	SH 16-85 SH 20-85	M8	9880IGH	325,80	12	324
16	26	90	SH 20-85	M10	91080IGH	350,90	12	324
18	26	90	SH 20-85	M12	91280IGH	384,20	12	324

Mezclador MR



MR	Precios		Embalaje
Denom.	Código	Precio €/100 u.	 (Uds.)
Mezclador	9MR	186,10	2 bolsas x 20 u.

Bomba soplante BOP y Escobilla PLRBK

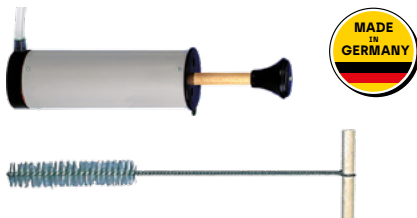





Características

- Para limpiar el agujero realizado con el taladro.
- Aplicación bomba soplante y escobilla.

BOP	Precios		Embalaje
Denom.	Código	Precio €/Unidad	 (Unidad)
Bomba soplante	BOP	49,80	1

PLRBK	Precios		Embalaje
Denom.	Longitud [mm]	Para agujeros de Ø [mm]	 (Unidad)
Escobilla	300	≤ 20	1

Pistolas de inyección

			Precios		Embalaje
Imagen	Denom.	Aplicación	Código	Precio €/Unidad	 (Unidad)
	OL 300	Para silicona Cartuchos resina 280 y 300 ml	300APP	20,40	1
	ECONOMAX OL 385	Cartuchos de resina de 385ml.	385OL	136,30	1
	OL 410 "COX"	Cartuchos resina de 410ml. Utilización intensiva.	410OL	104,40	1
	OL 410	Cartuchos resina de 410ml.	380APP	51,10	1

Anclaje altas cargas para ladrillo hueco ResiTHERM® 37/0

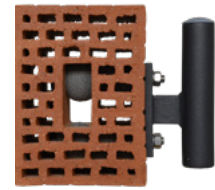

Características

- La solución perfecta para aplicaciones de altas cargas en paredes de ladrillo huecas.
- Sistema de alta resistencia para la fijación de toldos, marquesinas, balcones franceses, barandillas, antenas parabólicas, etc.
- No rompe el puente térmico.
- ResiTHERM® ha sido testado junto con el sistema de inyección ResiFIX® VYSF.

Adecuado para materiales

- Ladrillo hueco
- Ladrillo hueco de piedra caliza-silicio
- Hormigón alveolar
- Bloque de hormigón ligero hueco

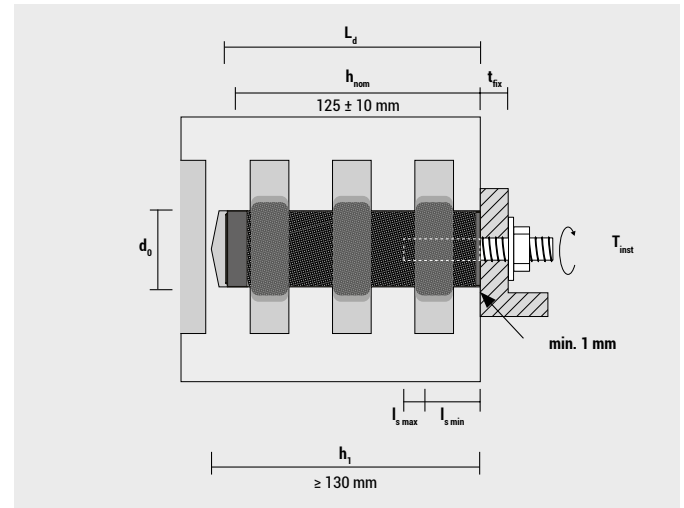

Montaje sobre ladrillo hueco

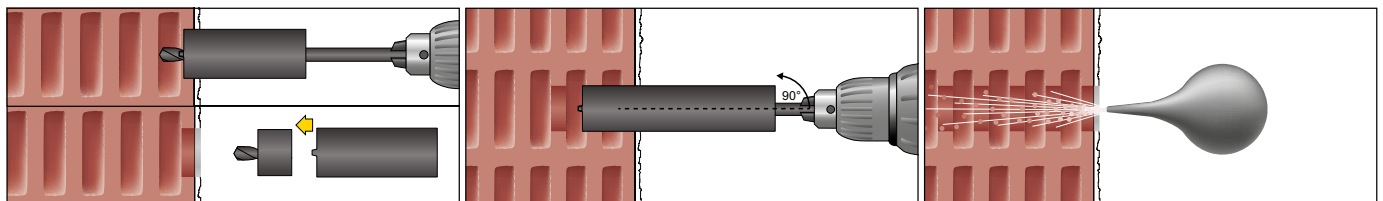

1. Coloque la corona de perforación; taladre con un destornillador inalámbrico (sin impacto) en la pared de ladrillo hueco; Retirar la ayuda para taladrar tras los primeros 10 mm.
2. Taladro (sin impacto); profundidad del taladro min. 130 mm.
3. Limpiar agujero.

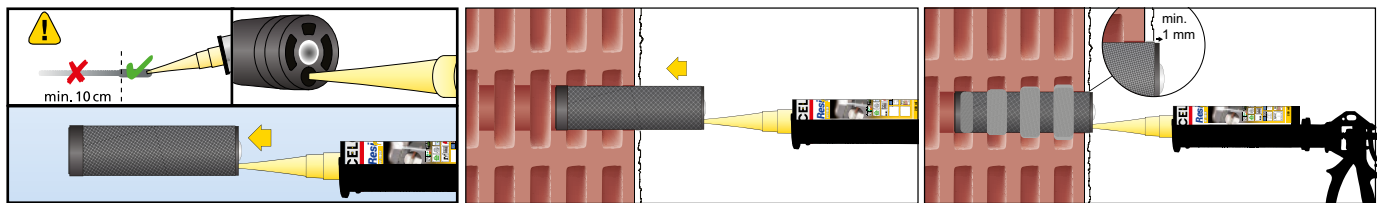

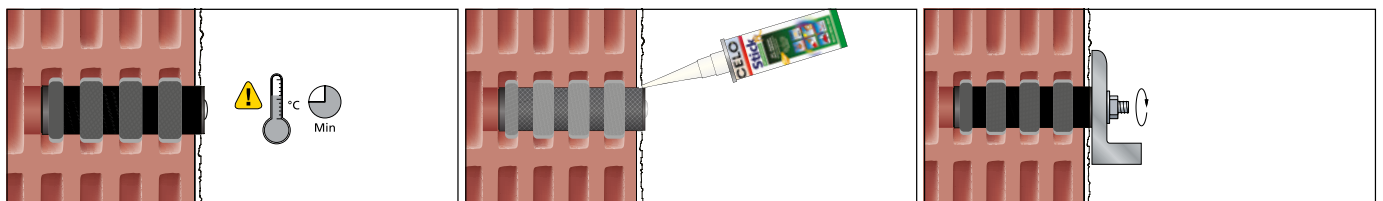

4. Presione ResiTHERM® S en la boquilla mezcladora.
5. Empuje ResiTHERM® S con cuidado en el orificio de perforación.
6. Llene ResiTHERM® S con el sistema de inyección ResiFIX.



7. Respete el tiempo de curado.
8. Rellene la junta con sellador StickFX XP, MS Polymer.
9. Instale el accesorio $T_{inst} \leq 20$ Nm.



ResiTHERM® 37/0 M12 para paredes de ladrillo hueco sin aislamiento				Precios		Embalaje	
Denom.	Contenido (envasados en bolsa)	L [mm]	Espesor aislamiento $h_0^{(1)}$ [mm]	Código	Precio €/Bolsa	 (Bolsas)	 (Bolsas)
RTH S	2x ResiTHERM® 37/0 M12 2x varilla roscada M12x70 mm, en acero inoxidable A4 2x arandelas M12 DIN 125, en acero inoxidable A4 2x tuercas hexagonales M12 DIN 934, en acero inoxidable A4 1x ResiFIX VY300SF	125	-	RTHS2	93,50	1	10

Anclaje altas cargas para ladrillo hueco con aislamiento ResiTHERM® 37



ResiTHERM®
37/200 M12

ResiTHERM®
37/160 M12

ResiTHERM®
37/120 M12



NOVEDAD

IFBT
tested
Institut für
Fassaden- und
Befestigungs-
technik

A4
STAINLESS
STEEL

BEST
NYLON
QUALITY

Características

- La solución ideal para instalaciones en ladrillo hueco con aislamiento.
- Método robusto para la fijación de toldos, marquesinas, balcones, barandillas, antenas parabólicas, etc. para sistemas SATE.
- Excelente aislamiento térmico, sin romper el puente térmico.
- Valores de resistencia excepcionalmente altos en ladrillo hueco.
- Instalación simple y rápida que ahorra tiempo y dinero.
- Producto listo para su uso: disponible en cuatro longitudes estándar.
- Se adapta a un aislamiento de gran espesor de hasta 200 mm
- Para paredes de ladrillos sin aislamiento: ResiTHERM® 37/0.



FIJACIÓN

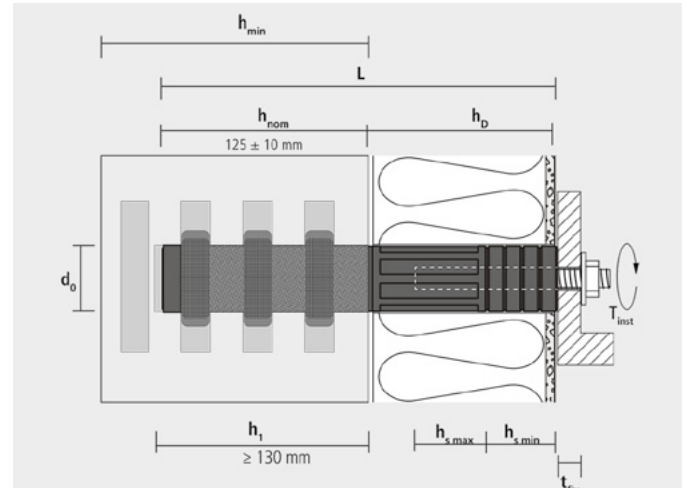

Adecuado para materiales

- Ladrillo hueco
- Ladrillo hueco de piedra caliza-silicio
- Hormigón alveolar
- Bloque de hormigón ligero hueco

Montaje sobre ladrillo hueco

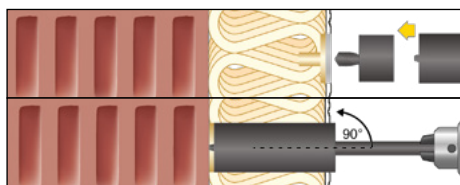

1. Coloque la guía en la broca de un destornillador (sin impacto) a través del material aislante a la pared de ladrillo hueco (quitar la guía de la perforación después de los primeros 10 milímetros).

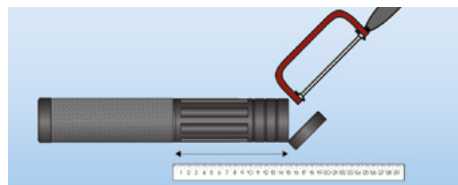

2. Medir el espesor del aislamiento y cortar ResiTHERM® si es necesario (máx. 40 mm).

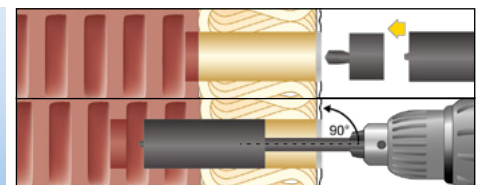

3. Colocar la guía de la broca y perforar al menos 130 mm en la pared del ladrillo hueco (quitar la guía de perforación después de los primeros 10 mm)

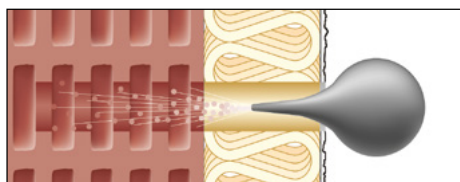

4. Limpiar el agujero.

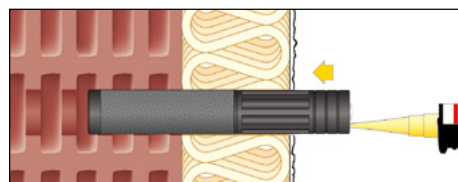

5. Introducir el ResiTHERM® cuidadosamente en el agujero con la boquilla de la mezcla.

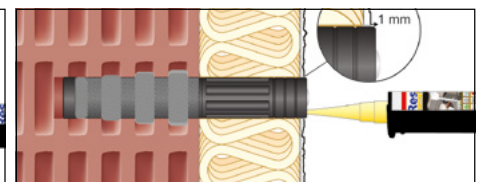

6. Rellena ResiTHERM® usando el sistema de inyección ResiFIX; hasta que siente claramente el final de la operación de llenado.

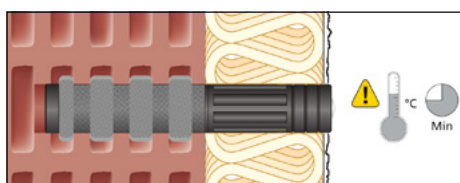

7. Respete el tiempo de secado.

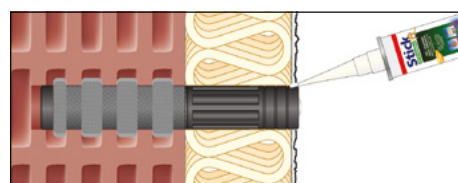

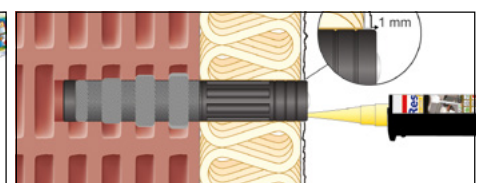

8. Llenar el espacio alrededor del ResiTHERM® con el sellador StickFX XP, MS Polymer.



9. Coloque la fijación $T_{inst} \leq 20$ Nm.



ResiTHERM®



ResiTHERM® 37/200 M12 Para espesores de aislamiento de 160 a 200 mm				Precios		Embalaje	
	Contenido (envasados en bolsa)	L [mm]	Espesor aislamiento h ₀ ⁽¹⁾ [mm]	Código	Precio €/Bolsa	 Bolsas	 Bolsas
RTH 200	2x ResiTHERM® 200 2x varilla roscada M12x70 mm, en acero inoxidable A4 2x arandelas M12 DIN 125, en acero inoxidable A4 2x tuercas hexagonales M12 DIN 934, en acero inoxidable A4 1x ResiFIX VY300SF	325	160 - 200	200RTH2	118,50	1	10



¹⁾ ResiTHERM® se puede cortar hasta 40 mm si es necesario.
ResiTHERM® está disponible en longitudes más largas a petición.



ResiTHERM® 37/160 M12 Para espesores de aislamiento de 120 a 160 mm				Precios		Embalaje	
	Contenido (envasados en bolsa)	L [mm]	Espesor aislamiento h ₀ ⁽¹⁾ [mm]	Código	Precio €/Bolsa	 (Bolsas)	 (Bolsas)
RTH 160	2x ResiTHERM® 160 2x varilla roscada M12x70 mm, en acero inoxidable A4 2x arandelas M12 DIN 125, en acero inoxidable A4 2x tuercas hexagonales M12 DIN 934, en acero inoxidable A4 1x ResiFIX VY300SF	285	120 - 160	160RTH2	116,90	1	10

¹⁾ ResiTHERM® se puede cortar hasta 40 mm si es necesario.



ResiTHERM® 37/120 M12 para espesores de aislamiento de 80 a 120 mm				Precios		Embalaje	
	Contenido (envasados en bolsa)	L [mm]	Espesor aislamiento h ₀ ⁽¹⁾ [mm]	Código	Precio €/Bolsa	 (Bolsas)	 (Bolsas)
RTH 120	2x ResiTHERM® 120 2x varilla roscada M12x70 mm, en acero inoxidable A4 2x arandelas M12 DIN 125, en acero inoxidable A4 2x tuercas hexagonales M12 DIN 934, en acero inoxidable A4 1x ResiFIX VY300SF	245	80 - 120	120RTH2	106,00	1	10

¹⁾ ResiTHERM® se puede cortar hasta 40 mm si es necesario.

ResiTHERM®

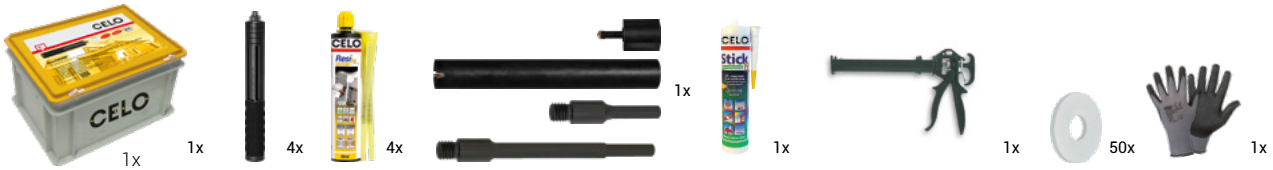

Kit de inicio ResiTHERM® <small>Proporcionado con una caja universal (30 x 40 x 23 cm)</small>					Precios	Embalaje
Contenido Art-No Accesorios					Precio €/Caja	Bolsas
SYS120RTH4	Kit de inicio RTH 120	4x ResiTHERM® 37/120 M12	+	300VSF 39ABH 39220BST 100M16AD 200M16AD BL290MSXP 345APVM 129021AS	617,40	1
SYS160RTH4	Kit de inicio RTH 160	4x ResiTHERM® 37/160 M12		4x varilla roscada M12 x 70 mm, en acero inoxidable A4 4x arandelas M12 DIN 125, en acero inoxidable A4 4x tuercas hexagonales M12 DIN 934, en acero inoxidable A4 2x sistemas de inyección ResiFIX VY300SF incluyendo 4x boquillas mezcladoras MD 1x guía de perforación para el taladro 1x broca Ø 39 x 220 mm	617,40	1
SYS200RTH4	Kit de inicio RTH 200	4x ResiTHERM® 37/200 M12		1x adaptador hexagonal para varilla M16 de 100 mm 1x adaptador hexagonal para varilla M16 de 200 mm 1x StickFX XP blanco, Polímero MS 1x pistola APVM 50x arandelas distanciadoras DIN 9021 por M12 (13 x 37 x 3 mm) 1 par de guantes de trabajo	617,40	1

Accesorios ResiTHERM®



Broca para ladrillo hueco BST

Guía de perforación para la ABH

Broca y guía de perforación <small>Para ResiTHERM®</small>				Precios		Embalaje
d [mm]	L [mm]	Rosca	Código	Precio €/u.	(Uds.)	
39	220	M16	39220BST	103,90	1	
35	60	-	39ABH	52,10	1	



AD100

AD 200

Adaptador hexagonal AD <small>para broca BST</small>				Precios		Embalaje
L [mm]	Rosca	Taladro varilla	Espesor aislamiento ≤ [mm]	Código	Precio €/u.	(Uds.)
100	M 16	Hexagonal	≤ 160	100M16AD	28,40	1
200	M 16	Hexagonal	160 - 260	200M16AD	46,20	1

ResiTHERM®



VY Vinylester sin estireno		Precios		Embalaje
Denom.	Código	Precio €/u.	 (Uds.)	
VY300SF	300VSF*	23,80	12	

* Con 2 cánulas.



StickFX adhesivo profesional multiuso XP			Precios		Embalaje
Denom.	Color	Descripción	Código	Precio €/u.	 (Uds.)
XP blanco	Blanco	Multiuso, pega, sella y rellena.	BL290MSXP	14,70	12



Arandela de distancia AS en poliamida, DIN 9021 de M12				Precios		Embalaje
Denom.	Exterior Ø [mm]	Interior Ø [mm]	h [mm]	Código	Precio €/u.	 (Uds.)
AS	37	13	3	129021AS	25,10	50

Utilizar para distanciamiento para la alineación (si es necesario).



BOP		Precios		Embalaje
Denom.	Código	Precio €/Unidad	 (Unidad)	
Bomba soplante	BOP	49,80	1	

Cápsula química VA



FIJACIÓN

Características

- Para fijar altas cargas en macizo cuando el anclaje está muy cerca de los bordes, o la distancia entre anclajes es muy pequeña.
- La cápsula no contiene estireno.
- Homologado para hormigón no fisurado.
- Almacenar fuera del alcance de la luz.
- Caducidad 2,5 años.
- Cápsula con base Vinylester.

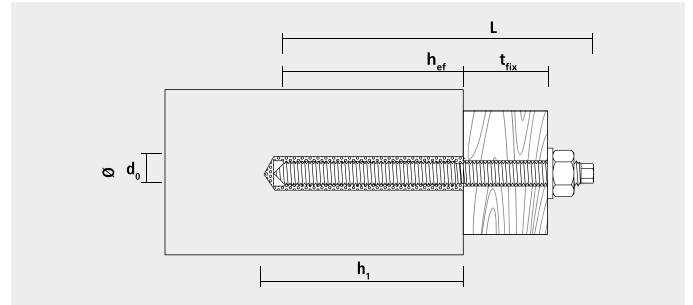

Adecuado para materiales

- Hormigón



Instalación

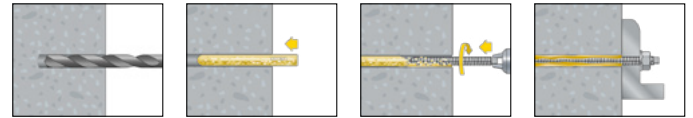

VA			Precios		Envase	Embalaje
\emptyset [mm]	h_1 [mm]	Para varilla VA AST [mm]	Código	Precio €/100 u.	 (Uds.)	 (Uds.)
12	90	M10	910VA	273,90	10	100
14	110	M12	912VA	330,20	10	100
18	125	M16	916VA	515,40	10	100
25	170	M20	920VA	595,80	5	50

Espárrago roscado VA AST



Características

- Cada caja contiene una herramienta de ajuste.

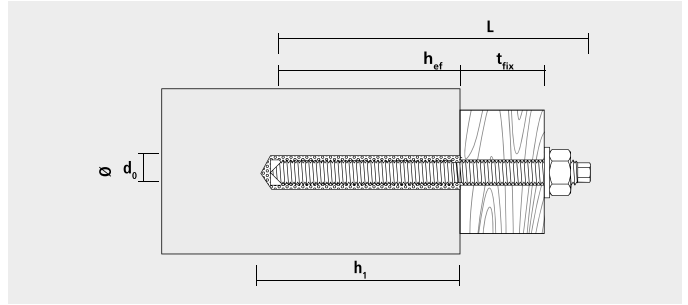

VA AST Acero galvanizado 5.8 con tuerca y arandela						Precios		Envase	Embalaje	
Ø [mm]	t _{fix} [mm]	h [mm]	L [mm]	Material	Rosca	Código	Precio €/100 u.	(Uds.)	(Uds.)	
M8	10	16	80	110	Cincado	M8	98100AST	174,00	10	-
M10	12	22	90	130	Cincado	M10	910130AST	218,30	10	100
M10	12	58	90	165	Cincado	M10	910165AST	248,20	10	120
M10	12	82	90	190	Cincado	M10	910190AST	281,30	10	120
M12	14	30	110	160	Cincado	M12	912160AST	323,50	10	100
M12	14	90	110	220	Cincado	M12	912220AST	324,50	10	60
M16	18	13	125	165	Cincado	M16	916165AST	457,70	10	120
M16	18	38	125	190	Cincado	M16	916190AST	579,10	10	60
M16	18	98	125	250	Cincado	M16	916250AST	714,50	10	120
M20	25	70	170	260	Cincado	M20	920260AST	1376,40	5	20

VA AST Acero inoxidable A4 con tuerca y arandela						Precios		Envase	Embalaje
Ø [mm]	t _{fix} [mm]	h [mm]	L [mm]	Material	Rosca	Código	Precio €/100 u.	(Uds.)	(Uds.)
10	16	80	100	INOX A4	M8	9X8100AST	388,30	10	-
12	22	90	130	INOX A4	M10	9X10130AST	570,10	10	120
14	30	110	160	INOX A4	M12	9X12160AST	1338,5	10	120
18	38	125	190	INOX A4	M16	9X16190AST	1908,40	10	120

Cargas recomendadas, distancia entre anclajes y al borde											
Tipo de anclaje	Hormigón C20/25 y C50/60					Distancia entre anclajes		Distancia al borde		Espesor mínimo	Par de apriete
	Resistencia a la tracción N _{per} [kN]	Resistencia a la cizalladura		Momento de flexión							
		Cincado V _{per} [kN]	A4 V _{per} [kN]	Cincado M _{per} [Nm]	A4 M _{per} [Nm]	S _{cr} [mm]	S _{min} [mm]	C _{cr} [mm]	C _{min} [mm]	d [mm]	T _{inst} [mm]
VA M8	3,6	4,4	5,0	8,8	10,1	240	60	120	60	110	10
VA M10	4,8	7,2	7,8	16,5	18,8	270	70	135	70	120	20
VA M12	6,4	10,4	11,9	30,8	34,3	330	85	165	85	150	40
VA M16	9,9	19,8	22,4	79,1	88,8	380	95	190	95	160	60
VA M20	15,9	31,3	35,3	156,6	175,8	510	130	255	130	230	120
VA M24	23,8	45,6	50,8	273,6	306,6	630	160	315	160	300	150
VA M30	60,0	60,0	60,0	642,0	402,0	700	280	350	140	330	400

Temperatura en el agujero (°C)	Tiempo mínimo de curado (min)
-5 a 0	360
0 a 5	180
5 a 10	90
10 a 20	40
>20	20

Instalación en seco o en cemento húmedo.
 Instalación para anclajes de M12 a M24 (no agua marina). El húmedo al tiempo de curado es el doble.
 Instalación en agujero inundado (no agua marina) permitido. El tiempo de curado es el doble.

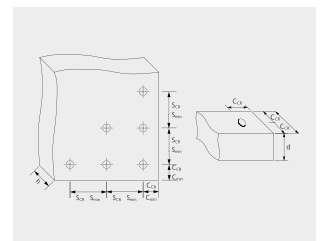

Adhesivos y sellantes

Adhesivo profesional **StickFX**



Características

- Sin disolventes. No ataca a las superficies.
- Elasticidad permanente 650%. Soporta vibraciones.
- Especial interiores y exteriores.
- Resistente al agua y a los rayos U.V.
- Pintable. Base acrílica se limpia con agua.
- Resistente a temperaturas -40°C +90°C.
- Fija en humedad.
- Stick FX HT alto agarre inicial.



Múltiples aplicaciones en saneamiento, calefacción, aire acondicionado, mantenimiento, náutica y construcción. Especial conductos.

Adhesivo sellante profesional transparente CL				Precios		Embalaje
Denom.	Cart. [ml]	Color	Descripción	Código	Precio €/100 u.	(Uds.)
CL	290	Transparente	Adhesivo y sellante	TR290MSCL	19,70	12

Multiuso, pega, sella y rellena XP				Precios		Embalaje
Denom.	Cart. [ml]	Color	Descripción	Código	Precio €/100 u.	(Uds.)
XP Blanco	290	Blanco	Multiuso, pega, sella y rellena	BL290MSXP	14,70	12
XP Gris	290	Gris	Multiuso, pega, sella y rellena	GR290MSXP	14,70	12

Adhesivo de montaje HT				Precios		Embalaje
Denom.	Cart. [ml]	Color	Descripción	Código	Precio €/100 u.	(Uds.)
HT	290	Blanco	"Adhesivo de montaje Alto agarre inicial"	BL290MSHT	16,50	12

StickFX Professional

Datos técnicos de +20 °C y 65 % de humedad.

	StickFX Professional CL	StickFX Professional XP	StickFX Professional HT
Descripción	Adhesivo sellante profesional transparente CL	Multiuso, pega, sella y rellena XP	Adhesivo de montaje HT
Color	100% transparente	Blanco y Gris	Blanco
Base	Polímero MS	Polímero MS	Polímero MS
Secado	Temperatura ambiente	Temperatura ambiente	Temperatura ambiente
Agarre inicial	16 kg/m ²	40 kg/m ²	ca. 200 kg/m ²
Agarre final	24 kg/cm ²	18 kg/cm ²	24 kg/cm ²
Solidificación capa externa	ca. 10 min.	ca. 10 min.	ca. 10 min.
Tiempo de secado	2 - 3 mm / 24 horas	2 - 3 mm / 24 horas	2 - 3 mm / 24 horas
Temperatura de trabajo	De 0 °C +35 °C	De 0 °C +35 °C	De 0 °C +35 °C
Temperatura de resistencia	De -40 °C hasta +90 °C	De -40 °C hasta +90 °C	De -40 °C hasta +90 °C
Densidad específica (DIN 53479)	1,04 g/ml	1,67 g/ml	1,62 g/ml
Máxima deformación (DIN EN ISO 11600)	20 %	20 %	20 %
Elasticidad de rotura (DIN 53504)	300 %	750 %	400 %
Resistencia al desgarre (DIN 53504)	2,4 N/mm ²	1,8 N/mm ²	3,5 N/mm ²
Dureza (DIN 53505)	38 ± 5	40 ± 5	65 ± 5
Almacenamiento	De 5 °C hasta 25 °C	De 5 °C hasta 25 °C	De 5 °C hasta 25 °C
Duración*	12 meses	12 meses	12 meses

* En embalaje sin abrir

Instrucciones de instalación adicionales

- Las superficies deben estar limpias, libres de polvo y sin grasa.
- Adherencia sobresaliente en varias superficies, como metales, plásticos / materiales sintéticos (poliestireno, policarbonato, PVC, poliamida y GFK, no ABS, PP, PE, PMMA, PTFE y silicona), espuma de poliestireno / poliestireno, corcho, hormigón, vidrio, madera, etc.
- Resistencia química.
- Buena resistencia al agua (incluido el agua de mar), disolventes alifáticos, ácidos y bases inorgánicos diluidos, aceites y grasas.
- Baja resistencia a los disolventes aromáticos, ácidos concentrados e hidrocarburos clorados.
- Dimensiones de la junta:
 - StickFX Professional CL: 1 - 3 mm para la adhesión, 2 - 3 mm para el sellado.
 - StickFX Professional XP: 2 - 10 mm para la adhesión, 5 - 30 mm para el sellado.
 - StickFX Professional HT: 2 - 10 mm para la adhesión, 5 - 30 mm para el sellado.

Sujeción



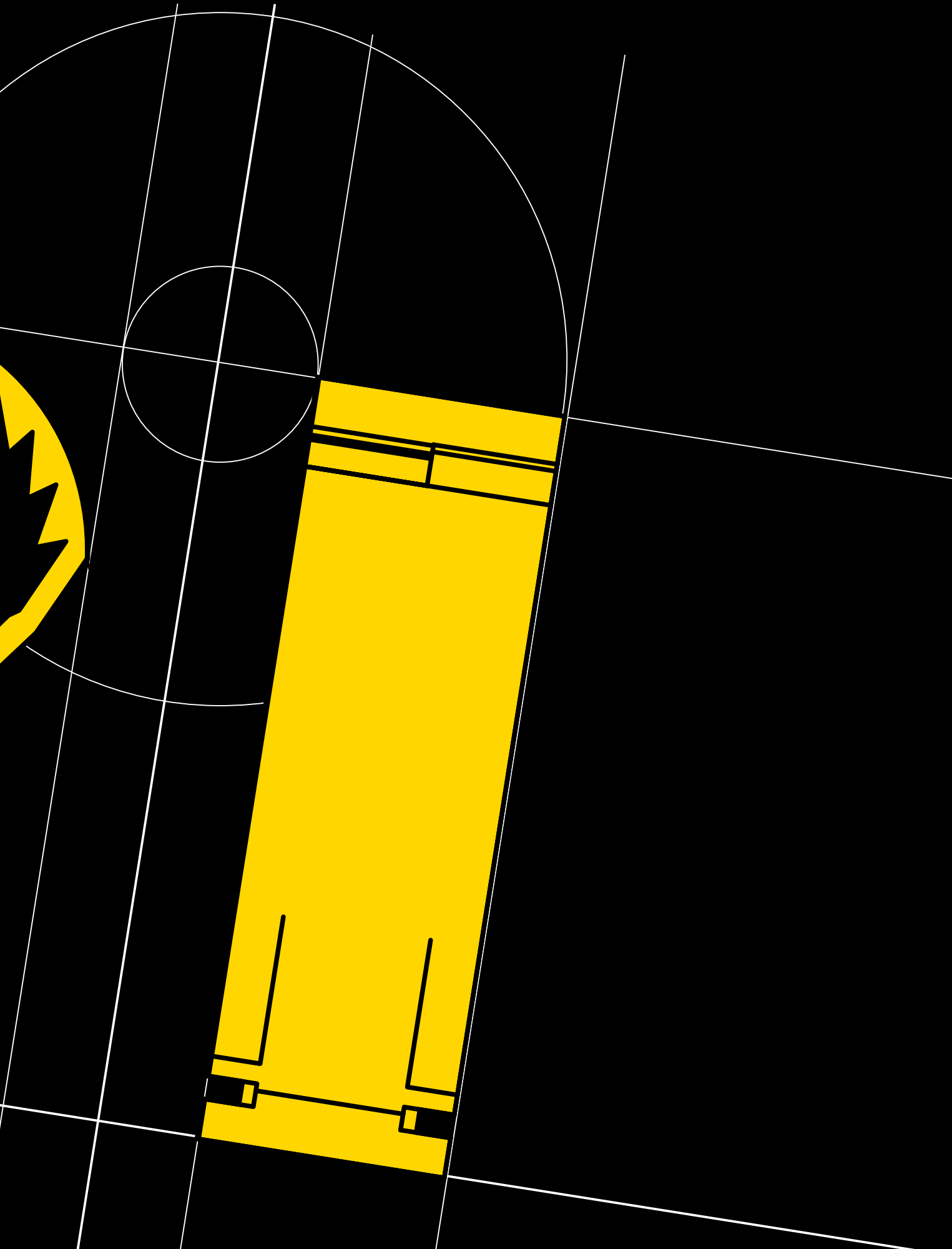

SUJECCIÓN

CELO

Fixings technology

Si vas a **ahorrar tiempo**
¡Ahórralo de verdad!



El sistema de las **Smart Clamps** está diseñado pensando en la **seguridad y productividad**, de manera que puedas realizar el **trabajo en un mínimo de tiempo**



Abrazadera directa a perfil Strut SSC

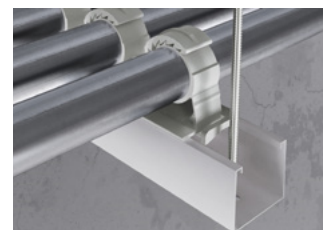
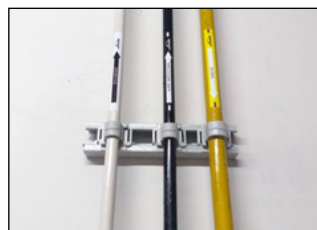

Características

- Abrazadera diseñada para instalar directamente en perfil de fibra SFS o STRUT de CELO, sin accesorios ni herramientas.
- Ahorro de tiempo, accesorios y mano de obra.
- Multidiámetro, una abrazadera cubre tres diámetros de tubo.
- Permite cerrar varias abrazaderas a la vez.
- Sistema de autobloqueo quedando perfectamente ajustada al perfil.
- Absorbe la vibración y dilatación.
- Aislamiento térmico y eléctrico.
- Temperatura de instalación: -5°C hasta +45°C.
- Temperatura de uso: -10°C hasta +90°C y puntualmente de -25°C hasta +110°C.
- Libre de halógenos.

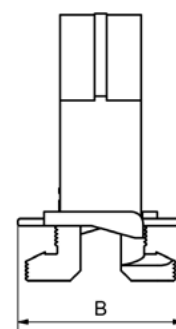
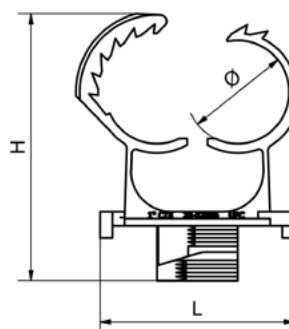

Cajas

SSC Gris				Precios		Envase	Embalaje
Ø [mm]	H [mm]	L [mm]	B [mm]	Código	Precio €/100 u.	Uds	Uds
14-18	46	48	41	918SSC	87,40	50	300
20-25	46	56	41	925SSC	99,80	25	225
25-32	48	65	41	932SSC	110,10	25	150
35-42	57	80	41	942SSC	139,50	20	120
48-55	72	95	41	955SSC	209,80	10	60
59-65	82	109	41	965SSC	300,60	8	48

Información Técnica

Ø mm	Cargas F _{rec} (Kg)	emt	cts	rgd	Homologación
14-18	23	1/2	1/2		UL
20-25	23	3/4	3/4	1/2	UL
25-32	34	1	1	3/4	UL
35-42	36	1-1/4	1-1/4&1-1/2	1&1-1/4	UL
48-55	45	1-1/2 & 2	2	1-1/2	UL
59-65	50			2	UL

Información Técnica

Ø [mm]	Ø Tubos		
	Hierro	Cobre	Plástico
14-18	3/8"	14-15-18	16
20-25	1/2"	22	20-25
25-32	3/4"	28	32
35-42	1"-1/4"	35-42	40-42
48-55	1"-1/2"	54	50
59-65	2"	63	63

Instalación

Inserta



Gira



Clipa

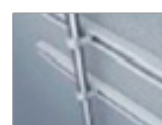

Perfil de fibra Strut SFS



NOVEDAD

PATENTADA

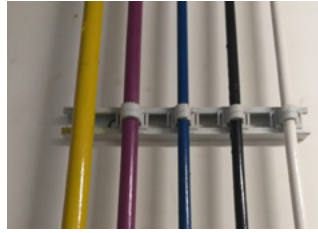

Características

- Fabricado en fibra de alta resistencia.
- Un 75% más ligero que un perfil de acero.
- Un 30% más ligero que un perfil de aluminio.
- Aislamiento térmico y eléctrico.
- Fácil manipulación y corte.
- Misma resistencia que el perfil de acero en distancias de hasta medio metro.
- Resistente en ambientes corrosivos, ácidos, salinos, alcalinos y de corrosión electroquímica (par galvánico).
- Temperatura de montaje: -10 °C / +60 °C
- Resistente al fuego V0.

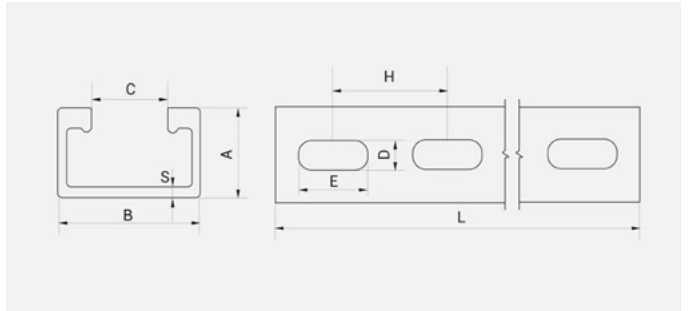

Instalación

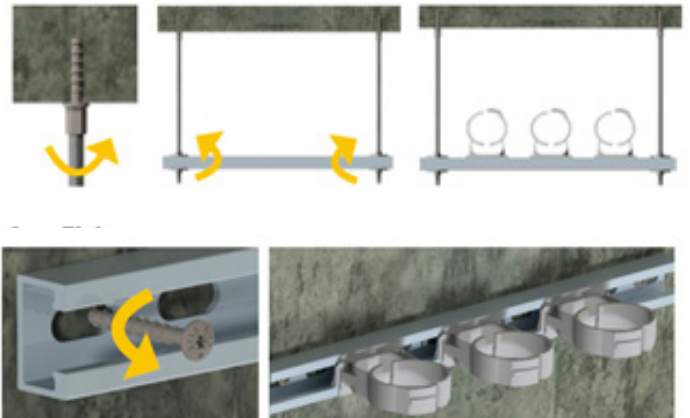

Aplicaciones

- Instalaciones para gases medicinales en hospitales.
- Instalaciones eléctricas en grajas e invernaderos.
- Instalaciones en piscifactorías, conserveras y cárnicas.
- Instalaciones en la industria química.

Cajas

SFS									Precios		Envase	Embalaje
B [mm]	A [mm]	L [mm]	S [mm]	C [mm]	D [mm]	E [mm]	H [mm]	Código	Precio €/u.	(Uds)	(Uds)	
41	25,5	508	3	22	30	12	50	4125SFS05	18,10	32	896	
41	25,5	914	3	22	30	12	50	4125SFS09	31,80	32	640	
41	25,5	1828	3	22	30	12	50	4125SFS18	56,70	18	360	
41	25,5	3000	3	22	30	12	50	4125SFS30	90,70	12	240	

*Hasta 24°C: 96 kg.

*Hasta 50°C: 77 kg.











**Carga máxima para longitud de 500 mm.



Abrazaderas plásticas y accesorios

Abrazadera Abranyl® Classic AN	125
Abrazadera Abranyl® ABT	126
Abrazadera Abranyl® Max ABM	127
Accesorios para abrazadera ABM	128
Abrazadera Abranyl® Doble ABMD	128
Abrazadera con tapa CH	129
Abrazadera Multiclip MC	130
Abrazadera Multiclip UT	131
Abrazadera Saniclip® SC	132
Abrazadera Saniclip® doble SCD	133
Abrazadera multitub MT y MTTE	134

Selector de abrazaderas de nylon

	AN	ABT	ABM	ABMD	CH	MC	UT	SC	SCD	MT
										
Rango (mm)	12 - 50	14 - 42	10 - 42	14 - 25	15 - 50	16 - 40	16 - 40	10 - 35	10 - 35	8 - 90
Materia Prima	PA6	PA6	PA6	PA6	PP	PA	HDPE	PP	PP	PA6
Rango Temperatura °C	Puntas de -25 y +110 En continuo -10 hasta 90	Puntas de -25 y +110 En continuo -10 hasta 90	Puntas de -25 y +110 En continuo -10 hasta 90	Puntas de -25 y +110 En continuo -10 hasta 90	En continuo -40 y + 80	Puntas de -30 y +120 En continuo -20 hasta 100	Puntas de -30 y +120 En continuo -20 hasta 100	Puntas de -30 y +120 En continuo -20 hasta 100	Puntas de -30 y +120 En continuo -20 hasta 100	Puntas de -25 y +110 En continuo -10 hasta 90
Resistencia Tracción (Kg)	60	60	60	60	45	10	10	10	10	50-310 s/m
Libre de Halógenos	Sí	Sí	Sí	Sí	Sí	Sí	Sí	Sí	Sí	Sí
ROHS conforme	Sí	Sí	Sí	Sí	No	Sí	Sí	No	No	No
Homologaciones	Kiwa	Kiwa UL	Kiwa	-	No	No	No	No	No	Applus
Absorción dilataciones	Sí	Sí	Sí	Sí	No	No	No	No	No	Sí
Multidímetro	Sí, 2 Ø por medida excepto medidas 10,12,14	Sí, 3 Ø por medida	Sí, 3 Ø por medida	Sí, 3 Ø por medida	No	No	No	No	No	Sí
Clavadora Gas	No	Sí	No	-	No	No	Sí	No	No	No
Fijación rápida	NP	Clavadora a Gas	con Tacomax®	-	No	No	Clavadora a Gas	No	No	No
Fijación rosca métrica	Sí, M6	No	Sí, con Insermax®	-	No	No	No	Sí, Tuerca M6 insertada	Sí, Tuerca M6 insertada	Montaje sólo en Perfil
Perfiles	2000PG, PB y PVC excepto medidas 10,12,14	2000PG, PB y PVC	2000PG, PB y PVC	2000PG, PB y PVC	2000PG, PB y PVC	2000PG, PB y PVC	2000PG, PB y PVC	2000PG	2000PG	PTTR
Montaje en paralelo	No	No	No	No	No	Sí	Sí	Sí, modelo doble	Sí, modelo doble	Sí
Aplicaciones	Eléctrico, sanitario	Eléctrico, sanitario	Eléctrico, sanitario	Eléctrico, sanitario	Eléctrico, sanitario	Inst. eléctrica	Inst. eléctrica	Inst. calefacción	Inst. calefacción	Inst. calefacción tubos enfundados y cableado

Abrazadera Abranyl® Classic AN



Características

- Absorbe las dilataciones del tubo.
- Multidiámetro. Una abrazadera cubre dos diámetros de tubo.
- Múltiples sistemas de fijación: perfil, taco-tornillo, taco de golpe.
- Instalación rápida, presionando el tubo se pueden cerrar varias abrazaderas al mismo tiempo sin necesidad de herramientas.
- Se puede fijar a perfiles 20x10, E2000PB, E2000PG y 1000PVC, también con taco de golpe NP 5x35, con taco FX Ø6 y tornillos Ø4,5x35/45
- Libre de halógenos.

Cajas

AN Gris				Precios		Envase	Embalaje
Ø [mm]	H [mm]	L [mm]	B [mm]	Código	Precio €/100 u.	(Uds)	(Uds)
12	18,5	18	13	912AN	41,50	100	900
14	20	20	14	914AN	45,10	100	900
15-16	24	19,5	15,5	915AN	45,00	100	900
18-20	29	24	15,5	918AN	53,30	100	600
22-25	31,5	27	15,5	922AN	61,50	100	600
26-28	32	29	15,5	926AN	65,40	100	600
30-32	35,5	34	17	930AN	87,00	100	-
35-40	43	42,5	18	935AN	111,90	100	-
47-50	54	51	19,7	947AN	200,80	50	-

AN Blanco				Precios		Envase	Embalaje
Ø [mm]	H [mm]	L [mm]	B [mm]	Código	Precio €/100 u.	(Uds)	(Uds)
15-16	24	19,5	15,5	9115AN	50,20	100	900
18-20	29	24	15,5	9118AN	59,70	100	600
22-25	31,5	27	15,5	9122AN	68,80	100	600
26-28	32	29	15,5	9126AN	73,10	100	600
30-32	35,5	34	17	9130AN	97,40	100	-

AN Negro				Precios		Envase	Embalaje
Ø [mm]	H [mm]	L [mm]	B [mm]	Código	Precio €/100 u.	(Uds)	(Uds)
12	18,5	18	13	9412AN*	42,50	100	900
15-16	24	19,5	15,5	9415AN	50,20	100	900
18-20	29	24	15,5	9418AN	59,70	100	900
22-25	31,5	27	15,5	9422AN	68,80	100	600
30-32	35,5	34	17	9430AN	97,40	100	-
35-40	43	42,5	18	9435AN	125,40	100	-

* Hasta agotar existencias.
- Color negro resistente a los rayos UV

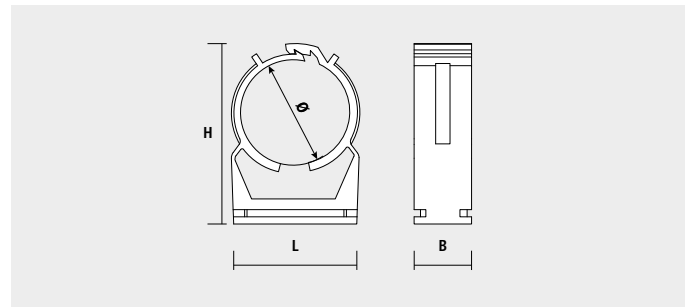
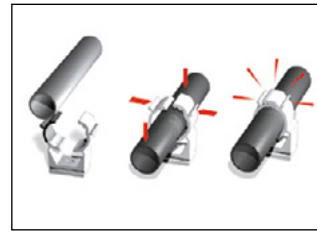

Bolsas

AN Blanco		Precios		Envase	Embalaje	Embalaje
Ø [mm]	Código	Precio €/Bolsa	(Uds)	(Bolsas)	(Uds)	
15-16	115AN	4,60	10	15	150	
18-20	118AN	5,60	10	15	150	
22-25	122AN	6,20	10	15	150	
26-28	126AN	4,40	6	15	90	
30-32	130AN	6,00	6	15	90	

Información Técnica

Ø [mm]	Ø Tubos		
	Hierro	Cobre	Plástico
12	-	12	-
14	1/4"	-	-
15-16	-	15	16
18-20	3/8"	18	20
22-25	1/2"	22	25
26-28	3/4"	28	-
30-32	-	-	32
35-40	1"	35	40
47-50	1-1/2"	-	50

Abrazadera Abranyl® ABT



Características

- Recomendada para clavadora a gas.
- Multidiámetro. Una abrazadera cubre tres diámetros de tubo.
- Instalación rápida presionando el tubo.
- Libre de halógenos.
- Se pueden montar en perfil 20x10: (2000PB,2000PG y 1000PVC).
- Absorbe las dilataciones del tubo.

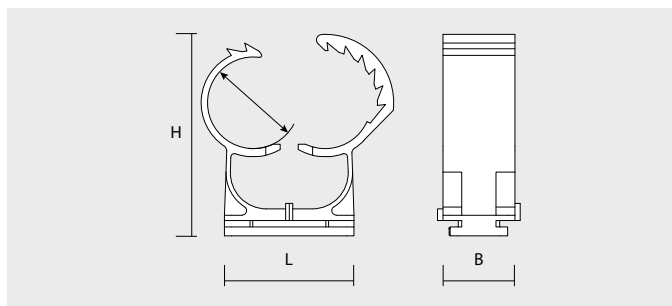

Cajas

ABT Gris				Precios		Envase	Embalaje
Ø [mm]	H [mm]	L [mm]	B [mm]	Código	Precio €/100 u.	(Uds)	(Uds)
14-18	35,6	24	16	918ABT	48,40	100	600
20-25	45,5	29	16	925ABT	57,90	50	450
25-32	53,6	36	16	932ABT	72,70	50	300
35-42	66,4	45	16	942ABT	116,80	25	150

ABT Blanco				Precios		Envase	Embalaje
Ø [mm]	H [mm]	L [mm]	B [mm]	Código	Precio €/100 u.	(Uds)	(Uds)
14-18	35,6	24	16	9118ABT	53,20	100	600
20-25	45,5	29	16	9125ABT	63,90	50	450
25-32	53,6	36	16	9132ABT	80,00	50	300
35-42	66,4	45	16	9142ABT	128,50	25	150

ABT Negro				Precios		Envase	Embalaje
Ø [mm]	H [mm]	L [mm]	B [mm]	Código	Precio €/100 u.	(Uds)	(Uds)
14-18	35,6	24	16	9418ABT	53,20	100	600
20-25	45,5	29	16	9425ABT	63,90	50	450
25-32	53,6	36	16	9432ABT	80,00	50	300
35-42	66,4	45	16	9442ABT	128,50	25	150

Color negro resistente a los rayos UV.

Bolsas

ABT Gris	Precios		Envase	Embalaje	Embalaje
Ø [mm]	Código	Precio €/Bolsa	(Uds)	(Bolsas)	(Uds)
14-18	18ABT	4,00	6	15	90
20-25	25ABT	4,90	6	15	90
25-32	32ABT	6,00	6	15	90
35-42	40ABT	8,10	6	15	90

Información Técnica

Ø [mm]	Ø Tubos		
	Hierro	Cobre	Plástico
14-18	3/8"	14-15-18	16
20-25	1/2"	22	20-25
25-32	3/4"	28	32
35-42	1"-1/4"	35-42	40-42

Abrazadera Abranyl® Max ABM



Características

- Multidiámetro. Una abrazadera cubre tres diámetros de tubo.
- Instalación rápida, presionando el tubo se cierran las abrazaderas.
- Se puede fijar con varilla roscada usando el accesorio roscado metálico IMX.
- Permite la fijación directa al clipar la abrazadera ABM en la cabeza del taco TMX.
- Libre de halógenos.
- Además se puede fijar a perfil, con taco-tornillo, tornillo métrico, taco de golpe y taco directo.

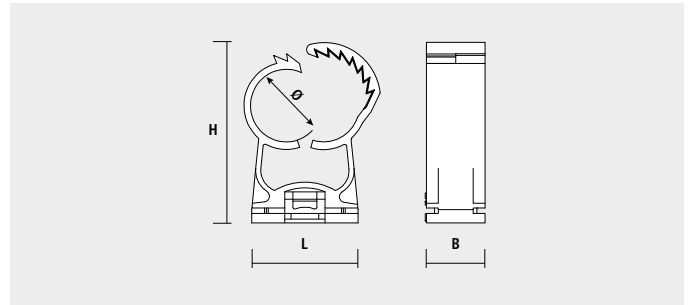

Cajas

ABM Gris				Precios		Envase	Embalaje
Ø [mm]	H [mm]	L [mm]	B [mm]	Código	Precio €/100 u.	(Uds)	(Uds)
10-14	32	22	16	914ABM	42,20	100	900
14-18	35	20	16	918ABM	45,70	100	900
14-18	35	20	16	918ABM20	48,80	20	360
20-25	48	29	16	925ABM	54,40	50	450
20-25	48	29	16	925ABM15	58,20	15	270
25-32	52	32	16	932ABM	66,60	100	-
25-32	52	32	16	932ABM10	71,30	10	180
35-42	66	45	16	942ABM	116,80	100	-

ABM Blanco				Precios		Envase	Embalaje
Ø [mm]	H [mm]	L [mm]	B [mm]	Código	Precio €/100 u.	(Uds)	(Uds)
14-18	35	20	16	9118ABM	50,40	100	900
20-25	48	29	16	9125ABM	59,80	50	450
25-32	52	32	16	9132ABM	73,10	100	-
35-42	66	45	16	9142ABM	128,50	100	-

ABM Negro				Precios		Envase	Embalaje
Ø [mm]	H [mm]	L [mm]	B [mm]	Código	Precio €/100 u.	(Uds)	(Uds)
14-18	35	20	16	9418ABM	50,40	100	900
20-25	48	29	16	9425ABM	59,80	50	450
25-32	52	32	16	9432ABM	73,10	100	-
35-42	66	45	16	9442ABM	128,50	100	-

Color negro resistente a los rayos UV.

Bolsas

ABM Gris		Precios		Envase	Embalaje	Embalaje
Ø [mm]	Código	Precio €/Bolsa	(Uds)	(Bolsas)	(Uds)	
14-18	18ABM	3,20	5	15	75	
20-25	25ABM	3,50	5	15	75	
25-32	32ABM	4,40	5	15	75	

Información Técnica

Ø [mm]	Ø Tubos		
	Hierro	Cobre	Plástico
10-14	1/8"-1/4"	10-12	-
14-18	3/8"	14-15-18	16
20-25	1/2"	22	20-25
25-32	3/4"	28	32
35-42	1"-1/4"	35-42	40-42

Accesorios para abrazadera ABM



TACOMAX

INSERMAX
M6

Características

- Anillos de autocentraje. Afincan el taco en el agujero y facilitan la instalación.
- Aletas en la cabeza para una mayor adaptación a los cables.

Accesorios para abrazadera ABM		Precios		Envase	Embalaje
	Medidas	Código	Precio €/100 u.	(Uds)	(Uds)
TACOMAX®	6 x 30	9630TMX	13,30	200	1.800
INSERMAX®	M6	96IMX	15,70	100	4.000



Instalación

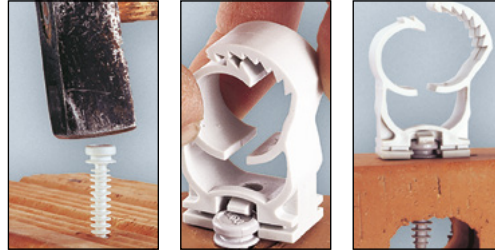

Aplicación con taco clavable para broca Ø6 (Tacomax®).

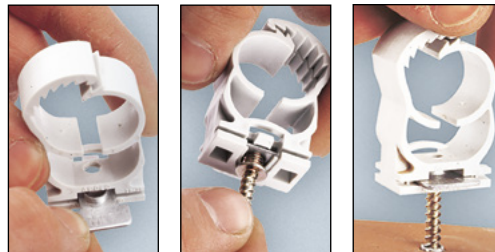

Aplicación con tuerca M6 (Insermax®).



Abrazadera Abranyl® Doble ABMD

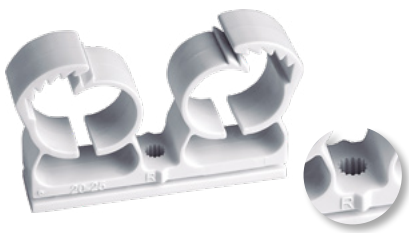

Características

- Montaje sobre perfil 20x10 (2000PG/PB/PVC).
- Agujero pasante 5 mm, se puede fijar con taco de golpe NP5x35, con taco FX Ø6 y tornillo Ø4,5x35/45.
- Libre de halógenos.
- Marcaje de alineación.

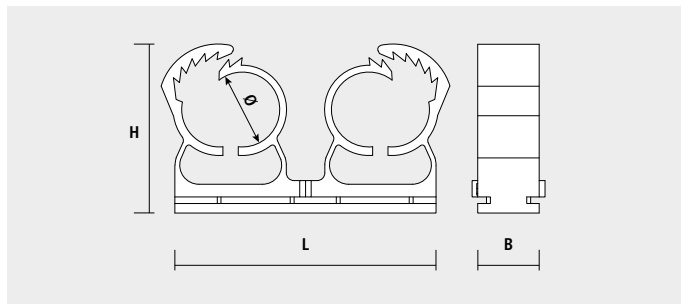

Cajas

ABMD Blanco				Precios		Envase	Embalaje
Ø [mm]	H [mm]	L [mm]	B [mm]	Código	Precio €/100 u.	(Uds)	(Uds)
14-18	35	58	16	9118ABMD	79,50	50	450
20-25	44	68	16	9125ABMD	86,20	25	225

Información Técnica

Ø [mm]	Ø Tubos		
	Hierro	Cobre	Plástico
14-18	3/8"	14-15-18	16
20-25	1/2"	22	20-25

Abrazadera con tapa CH



Características

- Montaje sobre perfil 20x10 (2000PG/PB).
- Agujero pasante de 5 mm, se puede fijar con taco FX Ø5 y tornillo Ø4x35/45.
- Abrazadera con tapa a presión.

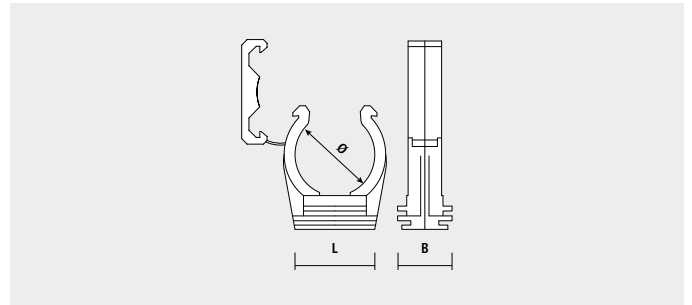

Cajas

CH			Precios		Envase	Embalaje
Ø [mm]	L [mm]	B [mm]	Código	Precio €/100 u.	(Uds)	(Uds)
15	16	19,5	915CH	34,00	100	600
18	19	19,5	918CH	38,70	100	600
20	21	19,5	920CH	40,40	100	600
22	23	19,5	922CH	42,10	100	600
25	26	19,5	925CH	45,00	100	600
28	28	19,5	928CH	50,90	50	300
32	32	19,5	932CH	60,20	50	300
40	38	19,5	940CH	74,60	50	-

Información Técnica

Ø [mm]	Ø Tubos	
	Cobre	Plástico
15	15	-
18	18	-
20	-	20
22	22	-
25	-	25
28	28	-
32	-	32
40	-	40

Abrazadera Multiclip MC

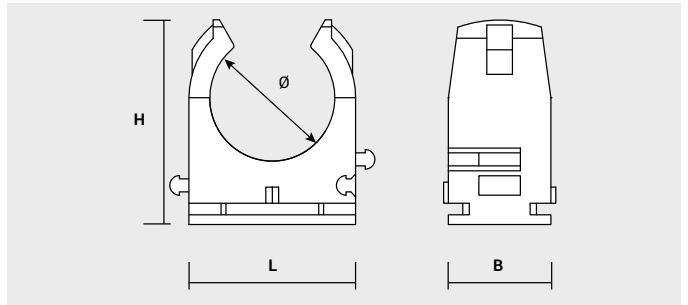
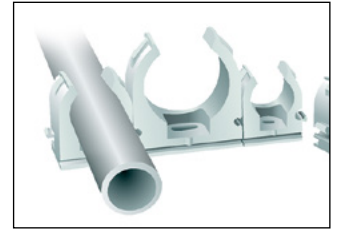

Características

- Montaje sobre perfil 2000PG/PB/PVC.
- Agujero pasante 4,5 [mm]
- Sistema modular de unión lateral para montaje en serie.
- Marcaje de alineado.

Cajas

MC Gris				Precios		Envase	Embalaje
Ø [mm]	H [mm]	L [mm]	B [mm]	Código	Precio €/100 u.	(Uds)	(Uds)
16	27	22	16	916MC	33,90	100	900
18	29	24	16	918MC	38,00	100	900
20	31,5	26	16	920MC	42,00	100	900
22	34	28	16	922MC	46,70	100	900
25	35	31	16	925MC	51,10	100	600
32	43	39	16	932MC	71,00	50	450
40	51	47	16	940MC	88,20	50	300

MC Crema				Precios		Envase	Embalaje
Ø [mm]	H [mm]	L [mm]	B [mm]	Código	Precio €/100 u.	(Uds)	(Uds)
16	27	22	16	9CR16MC	34,40	100	900
20	31,5	26	16	9CR20MC	43,80	100	900
25	35	31	16	9CR25MC	53,20	100	600
40	51	47	16	9CR40MC	83,20	50	300

MC Negro				Precios		Envase	Embalaje
Ø [mm]	H [mm]	L [mm]	B [mm]	Código	Precio €/100 u.	(Uds)	(Uds)
20	31,5	26	16	9420MC	43,80	100	900
25	35	31	16	9425MC	53,20	100	600

Color negro resistente a los rayos UV.

Bolsas

MC Gris		Precios		Envase	Embalaje	Embalaje
Ø [mm]	Código	Precio €/Bolsa	(Uds)	(Bolsas)	(Uds)	
16	16MC	5,10	10	15	150	
18	18MC	6,00	6	15	90	
20	20MC	6,20	6	15	90	
25	25MC	7,80	6	15	90	

Información Técnica

Ø [mm]	Ø Tubos	
	Hierro	Cobre
16	-	16
18	18	-
20	-	20
22	22	-
25	-	25
32	-	32
40	-	40

Abrazadera Multiclip UT



Características

- Sistema modular de unión lateral para montaje en serie.
- Compatible con clavadora FORCE ONE.
- Montaje sobre perfil 20x10 (2000PG/PB/PVC).
- Marcaje de alineado.

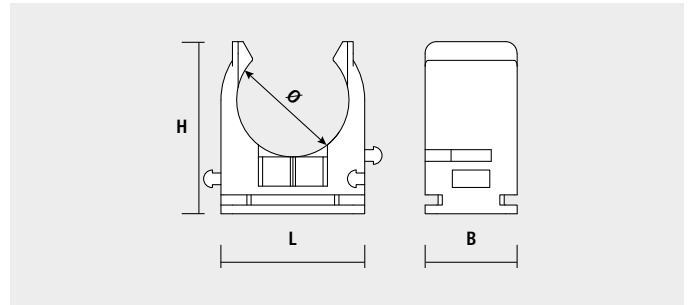

Cajas

UT Gris				Precios		Envase	Embalaje
Ø [mm]	H [mm]	L [mm]	B [mm]	Código	Precio €/100 u.	(Uds)	(Uds)
16	25,5	23	16	916UT	33,00	100	900
20	29,5	25	16	920UT	40,20	100	900
25	34	30,5	16	925UT	48,80	100	900
32	42	38	16	932UT	59,10	50	450
40	50	46	16	940UT	78,30	50	300

Información Técnica

Ø [mm]	Ø Tubos
	Cobre
16	16
20	20
25	25
32	32
40	40

Abrazadera Saniclip® SC



Características

- Tuerca M6 insertada de latón.
- Montaje sobre perfil 20x10 (2000PG/PB/PVC).
- Se puede fijar con tirafondo TF M6 y taco FX Ø6.

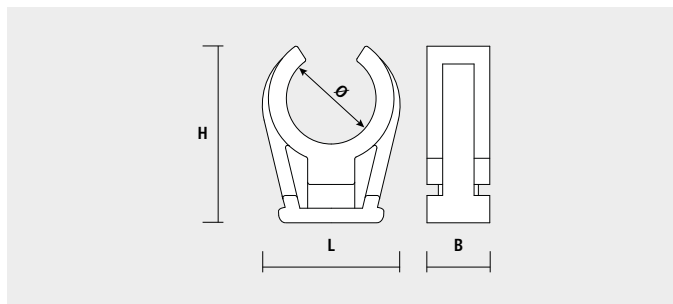

Cajas

SC Blanco				Precios		Envase	Embalaje
Ø [mm]	H [mm]	L [mm]	B [mm]	Código	Precio €/100 u.	(Uds)	(Uds)
10	20	18	12	9110SC	38,00	100	1.800
12	22	20	12	9112SC	36,60	100	900
15	26	24	12	9115SC	37,30	100	900
18	30	27	14	9118SC	44,90	100	900
22	32	31	14	9122SC	45,90	100	900
28	47	39	14	9128SC	55,50	50	450
35	54	50	14	9135SC	80,80	25	225

Bolsas

SC Blanco	Precios		Envase	Embalaje	Embalaje
Ø [mm]	Código	Precio €/Bolsa	(Uds)	(Bolsas)	(Uds)
12	112SC	6,20	10	15	150
15	115SC	6,60	10	15	150
18	118SC	7,80	10	15	150
22	122SC	8,20	10	15	150
28	128SC	8,90	10	15	150

Información Técnica

Ø [mm]	Ø Tubos
	Cobre
10	10
12	12
15	15
18	18
22	22
28	28
35	35

Abrazadera Saniclip® doble SCD



Características

- Tuerca M6 insertada de latón.
- Montaje sobre perfil 20x10 (2000PG/PB/PVC).
- Se puede fijar con tirafondo TF M6 y taco FX Ø6.

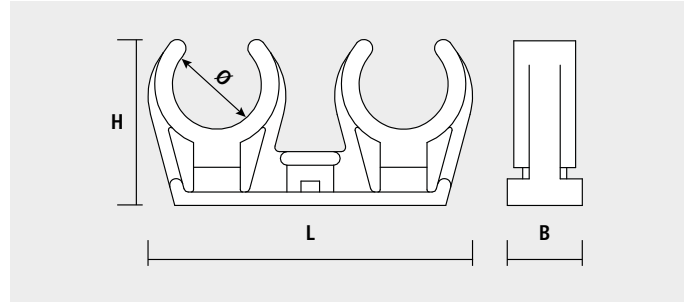
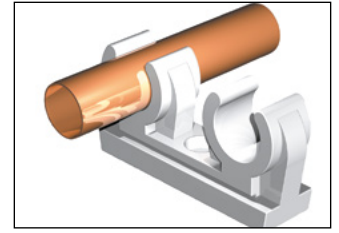

Cajas

SCD Blanco				Precios		Envase	Embalaje
Ø [mm]	H [mm]	L [mm]	B [mm]	Código	Precio €/100 u.	(Uds)	(Uds)
15	26	60	12	9115SCD	66,40	50	450
18	30	65	14	9118SCD	78,20	50	450
22	32	73	14	9122SCD	84,50	25	225
28	47	89	14	9128SCD	110,00	25	150

Bolsas

SCD Blanco	Precios		Envase	Embalaje	Embalaje
Ø [mm]	Código	Precio €/Bolsa	(Uds)	(Bolsas)	(Uds)
12	112SCD	10,20	10	15	150
15	115SCD	11,10	10	15	150
18	118SCD	12,80	10	15	150
22	122SCD	13,70	10	15	150
28	128SCD	14,90	10	15	150

Información Técnica

Ø [mm]	Ø Tubos
	Cobre
15	15
18	18
22	22
28	28

Abrazadera multitub MT y MTTE

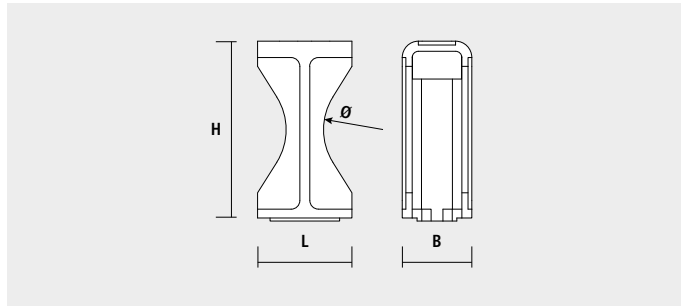

MT / MTTE

Características

- MT:
 - Reduce la distancia entre tubos a fijar.
 - Ideal para instalaciones de tubos en paralelo.
 - Montaje con perfiles PTTR / 38x40 / T2000P.
 - Libre de halógenos.
 - Facilita la fijación de tubos con coquilla al no tener que cortarla en los puntos de sujeción.
 - Medidas 8-36, 14-48, 24-72 con tornillo DIN84.
 - Medida 60-90 con tornillo DIN912.
- MTTE:
 - Montaje con perfiles 2000PB y 2000 PG.
 - Ideal para tubos de calefacción.
 - Facilita la fijación de tubos con coquilla al no tener que cortarla en los puntos de sujeción.

Cajas

MT					Precios		Envase	Embalaje
Ø [mm]	L [mm]	H [mm]	B [mm]	d _s [mm]	Código	Precio €/100 u.	(Uds)	(Uds)
8-36	23	36	26	M8	94836MT	132,90	100	600
14-48	26	45	26	M8	941448MT	157,60	100	-
24-72	38	70	38	M8	942472MT	217,20	100	-
60-90	70	100	34	M8	946090MT	493,90	50	-

MTTE					Precios		Envase	Embalaje
Ø [mm]	L [mm]	H [mm]	B [mm]	d _s [mm]	Código	Precio €/100 u.	(Uds)	(Uds)
8-36	16,5	34	18	M4	94836MTTE	109,30	100	900

Tabla de resistencia

Ø [mm]	Resistencia a tracción última		Resistencia a cizalla última	
	2 Tubos [Kg]	Batería [Kg]	2 Tubos [Kg]	Batería [Kg]
Ø 8-36	38	60	62	126
Ø 14-48	59	126	74	134
Ø 24-72	64	112	72	128
Ø 60-90	102	217	148	310

Grapas y bridas plásticas

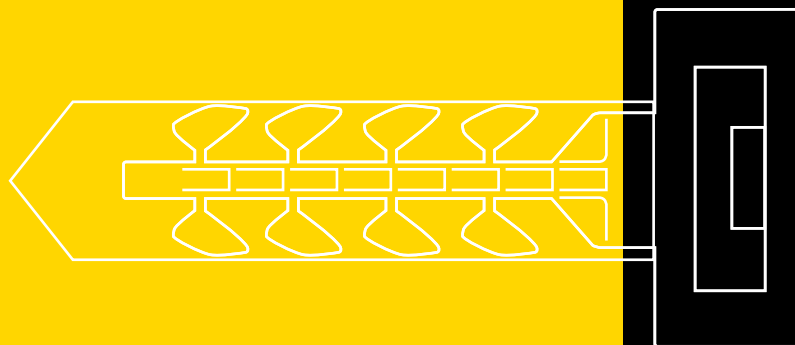

Taco brida rápido InsertFIX	136
Tacobrid TB	137
Brida de nylon CCT	138
Grapa simple de plástico FTS	139
Grapa doble de plástico FTD	140
Clip plástico TCB	141
Plastigrap® PLG	142
Plastigrap® multidímetro MPLG	143
Basebrid adhesiva BBA	144
Basebrid atornillable BBT	144

Taco brida rápido InsertFIX

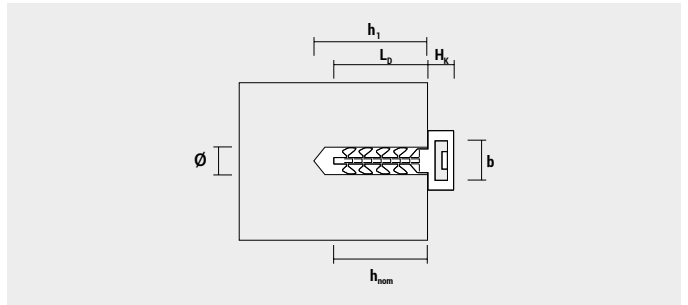
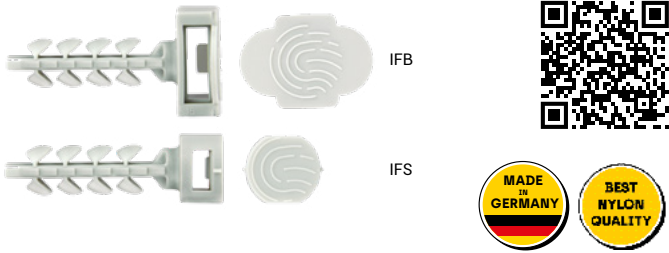

Características

- Instalación sin herramientas, inserción manual.
- Sistema de bloqueo de bridas.
- Instalación con broca de Ø6 mm y 30 mm de profundidad.
- IFB permite la instalación de bridas de hasta 9 mm de ancho o la combinación de dos bridas de 4,8 [mm]
- IFS permite la instalación de bridas de hasta 4,8 mm de ancho, quedando la fijación debajo del tubo.
- Marca de huella en la cabeza, con textura y forma suave para reforzar su instalación.

Adecuado para materiales

- Hormigón.
- Ladrillo macizo.
- Piedra.
- Hormigón poroso.
- Ladrillo hueco.

Instalación

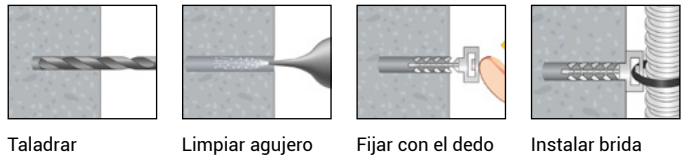

Cajas

IFB Gris						Precios		Envase	Embalaje
Ø [mm]	H ₁ [mm]	H _{nom} [mm]	L _D [mm]	H _K [mm]	b [mm]	Código	Precio €/ 100.	(Uds)	(Uds)
6	30	25	31	6	10,20	96IFB	12,20	100	2.700

IFB Negro						Precios		Envase	Embalaje
Ø [mm]	H ₁ [mm]	H _{nom} [mm]	L _D [mm]	H _K [mm]	b [mm]	Código	Precio €/ 100.	(Uds)	(Uds)
6	30	25	31	6	10,20	946IFB	12,20	100	2.700

Color negro resistente a los rayos UV.

IFS Gris						Precios		Envase	Embalaje
Ø [mm]	H ₁ [mm]	H _{nom} [mm]	L _D [mm]	H _K [mm]	b [mm]	Código	Precio €/ 100.	(Uds)	(Uds)
6	30	25	31	6	5,5	96IFS	11,00	100	4.800

IFS Negro						Precios		Envase	Embalaje
Ø [mm]	H ₁ [mm]	H _{nom} [mm]	L _D [mm]	H _K [mm]	b [mm]	Código	Precio €/ 100.	(Uds)	(Uds)
6	30	25	31	6	5,5	946IFS	11,00	100	4.800

Botes

IFB Gris		Precios		Envase	Embalaje
Ø [mm]	Código	Precio €/Bote	(Uds)	(Uds)	
6	96EXPIFB	16,10	125	1.250	

IFB Negro		Precios		Envase	Embalaje
Ø [mm]	Código	Precio €/Bote	(Uds)	(Uds)	
6	946EXPIFB	16,10	125	1.250	

IFS Gris		Precios		Envase	Embalaje
Ø [mm]	Código	Precio €/Bote	(Uds)	(Uds)	
6	96EXPIFS	29,20	250	2.500	

IFS Negro		Precios		Envase	Embalaje
Ø [mm]	Código	Precio €/Bote	(Uds)	(Uds)	
6	946EXPIFS	29,20	250	2.500	

Cargas recomendadas F _{Rec} [kN]		
Carga a tracción de fallo	IFB	IFS
Hormigón C20/25 F _{eff} [kN]	0,08	0,08
Ladrillo hueco F _{eff} [kN]	0,08	0,08
Bloque hormigón F _{eff} [kN]	0,08	0,08

Incluye factor de seguridad 5.

Tacobrid TB

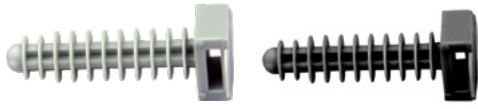

Características

- Anillos de autocentrado. Centran el taco en el agujero y facilitan la instalación.
- Aletas en la cabeza para una mayor adaptación a los cables.

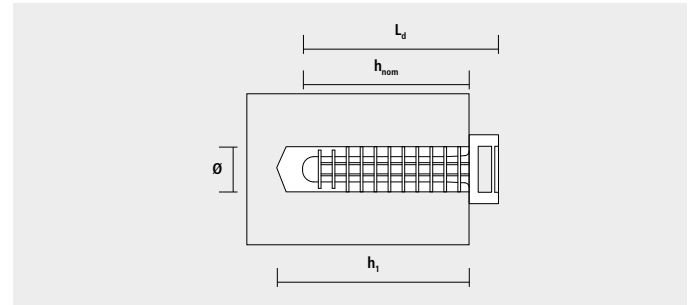

Instalación

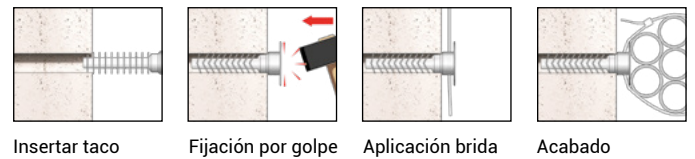

Cajas

TB Gris				Precios		Envase	Embalaje
Ø [mm]	H ₁ [mm]	H _{nom} [mm]	L _D [mm]	Código	Precio €/100 u.	(Uds)	(Uds)
8	45	37	43,5	98TB	15,30	100	1200

TB Negro				Precios		Envase	Embalaje
Ø [mm]	H ₁ [mm]	H _{nom} [mm]	L _D [mm]	Código	Precio €/100 u.	(Uds)	(Uds)
6	35	30	36,5	946TB	13,10	100	1.200
8	45	37	43,5	948TB	15,30	100	1.200
8	45	37	43,5	948ETB*	6,60	5.000	-

Color negro resistente a los rayos UV.
* Envasado gran volumen.

Bolsas

TB Negro		Precios		Envase	Embalaje	Embalaje
Ø [mm]	Código	Precio €/Bolsa	(Uds)	(Bolsas)	(Uds)	
8	48TB	4,30	25	15	375	

Cargas recomendadas F_{Rec} [kN]

Ø [mm]	Hormigón [kN]	Bloque hormigón [kN]	Ladrillo hueco [kN]
8	0,14	0,07	0,045

Brida de nylon CCT

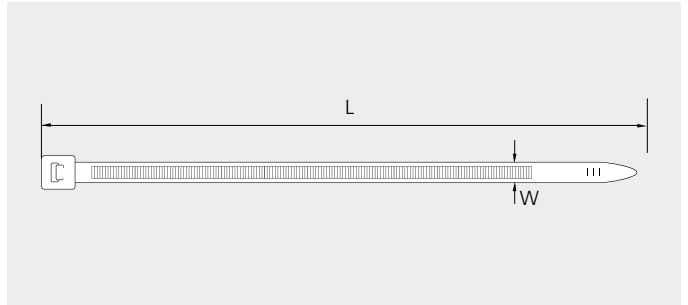
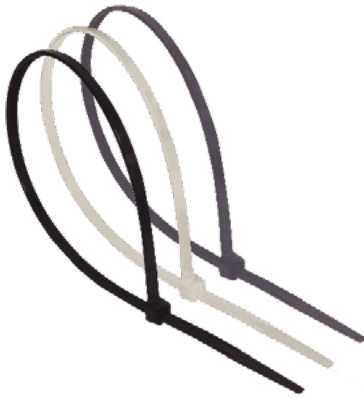

Características

- Para interior y exterior (color negro).
- Para interior (color natural).
- Temperatura de uso -40°C a +85°C.
- Temperatura mínima de instalación -10°C.
- Libre de halógenos.
- Resistente a los rayos UV (negro).

Bolsas

CCT Negro			Precios		Envase	Embalaje	Embalaje
W [mm]	L [mm]	Ø Mazo [mm]	Código	Precio €/100 u.	(Uds)	(Bolsas)	(Uds)
2,5	100	20,5	425100CCT	1,20	100	10	1.000
2,5	150	39,8	425150CCT	2,10	100	10	1.000
2,5	200	52,5	425200CCT	2,50	100	10	1.000
3,6	140	33	436140CCT	2,70	100	10	1.000
3,6	200	52,5	436200CCT	3,70	100	10	1.000
3,6	300	84	436300CCT	5,60	100	10	1.000
3,6	370	106	436370CCT	6,90	100	10	1.000
4,8	200	49,5	448200CCT	4,80	100	10	1.000
4,8	250	65	448250CCT	6,80	100	10	1.000
4,8	300	81	448300CCT	7,40	100	10	1.000
4,8	370	103,5	448370CCT	9,30	100	10	1.000
4,8	430	122,5	448430CCT	12,10	100	10	1.000
7,6	150	35	476150CCT	9,60	100	10	1.000
7,6	200	50,9	476200CCT	10,20	100	10	1.000
7,6	300	82,8	476300CCT	14,20	100	10	1.000
7,6	365	105	476365CCT	17,10	100	10	1.000
7,6	450	130,5	476450CCT	25,90	100	10	1.000
7,6	550	159	476550CCT	32,20	100	10	1.000
8,8	760	229,5	488760CCT	57,00	50	10	500
9,0	810	245	490810CCT	65,90	50	10	500
12,6	530	156	4126530CCT	78,60	50	10	500
12,6	1030	315	41261030CCT	158,40	50	10	500

Color negro resistente a los rayos UV.

CCT Gris			Precios		Envase	Embalaje	Embalaje
W [mm]	L [mm]	Ø Mazo [mm]	Código	Precio €/100 u.	(Uds)	(Bolsas)	(Uds)
4,8	200	49,5	48200CCT	4,80	100	10	1.000
4,8	300	81	48300CCT	7,40	100	10	1.000

Cargas recomendadas F_{Rec} [kN]

Referencia	Resistencia máxima recomendada [kN]
2,5	0,08
3,6	0,18
4,8	0,22
7,6	0,55
8,8	0,80
9,0	0,80
12,6	1,10

CCT Natural			Precios		Envase	Embalaje	Embalaje
W [mm]	L [mm]	Ø Mazo [mm]	Código	Precio €/100 u.	(Uds)	(Bolsas)	(Uds)
2,5	100	20,5	125100CCT	1,20	100	10	1.000
2,5	150	39,8	125150CCT	2,10	100	10	1.000
2,5	200	52,5	125200CCT	2,50	100	10	1.000
3,6	140	33	136140CCT	2,70	100	10	1.000
3,6	200	52,5	136200CCT	3,70	100	10	1.000
3,6	300	84	136300CCT	5,60	100	10	1.000
3,6	370	106	136370CCT	6,90	100	10	1.000
4,8	200	49,5	148200CCT	4,80	100	10	1.000
4,8	250	65	148250CCT	6,80	100	10	1.000
4,8	300	81	148300CCT	7,40	100	10	1.000
4,8	370	103,5	148370CCT	9,30	100	10	1.000
4,8	430	122,5	148430CCT	12,10	100	10	1.000
7,6	150	35	176150CCT	9,60	100	10	1.000
7,6	200	50,9	176200CCT	10,20	100	10	1.000
7,6	300	82,8	176300CCT	14,20	100	10	1.000
7,6	365	105	176365CCT	17,10	100	10	1.000
7,6	450	130,5	176450CCT	25,90	100	10	1.000
7,6	550	159	176550CCT	32,20	100	10	1.000
8,8	760	229,5	188760CCT	57,00	50	10	500
9,0	810	245	190810CCT	65,90	50	10	500
12,6	530	156	1126530CCT	78,60	50	10	500
12,6	1030	315	11261030CCT	158,40	50	10	500



Expositor de bridas de 1 metro

Potencia tu punto de venta con nuestro expositor de bridas.

Más información a info@celofixings.es o contacta con nuestro comercial.

Grapa simple de plástico FTS

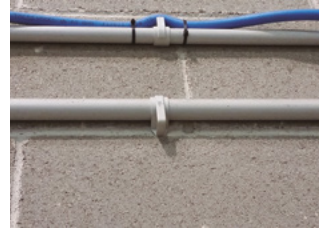

Características

- Cada grapa fija 3 diámetros de tubo.
- Libre de halógenos.
- Anillos de autocentraje alinean el taco con el agujero.
- Taladro previo Ø8 [mm]

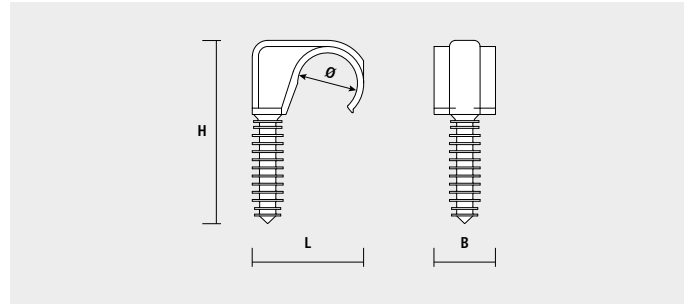

Cajas

FTS Gris				Precios		Envase	Embalaje
Ø [mm]	H [mm]	L [mm]	B [mm]	Código	Precio €/100 u.	(Uds)	(Uds)
18	55	30	20	918FTS	51,30	100	900
22	59	36,5	20	922FTS	55,20	100	600
28	64	43,5	20	928FTS	64,70	50	450

Información Técnica

Ø [mm]	Ø Tubos		
	Hierro	Cobre	Plástico
18	3/8"	18	16
22	1/2"	22	20
28	3/4"	28	25

Instalación

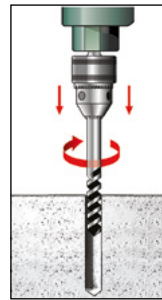

Taladrar con broca de 8 [mm]

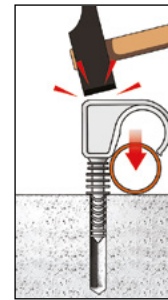

Presentar tubo y golpear.

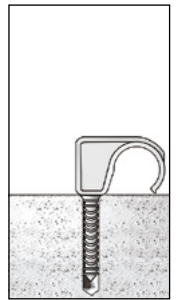

Fijación terminada.

Bolsas

FTS Gris	Precios		Envase	Embalaje	Embalaje
Ø [mm]	Código	Precio €/Bolsa	(Uds)	(Bolsas)	(Uds)
18	18FTS	4,60	6	15	90
22	22FTS	5,00	6	15	90

SUJECIÓN

Grapa doble de plástico FTD

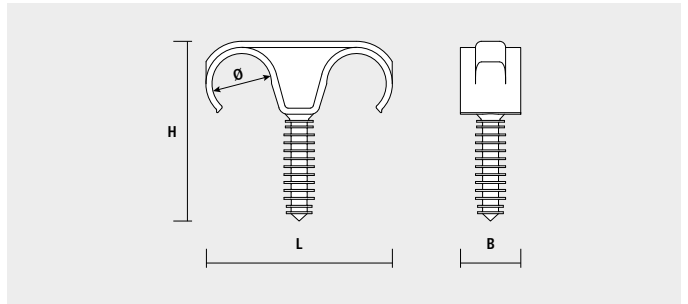

Características

- Cada grapa fija Ø3 de tubo.
- Libre de halógenos.
- Anillos de autocentraje alinea el taco con el agujero.
- Taladro previo Ø8 [mm]

Cajas

FTD Gris				Precios		Envase	Embalaje
Ø [mm]	H [mm]	L [mm]	B [mm]	Código	Precio €/100 u.	(Uds)	(Uds)
18	55	51	20	918FTD	66,60	50	450
22	59	62	20	922FTD	70,70	50	300
28	64	73	20	928FTD	97,00	50	-

Información Técnica

Ø [mm]	Ø Tubos		
	Hierro	Cobre	Plástico
18	3/8"	18	16
22	1/2"	22	20
28	3/4"	28	25

Instalación

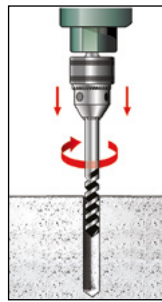

Taladrar con broca de 8 [mm]

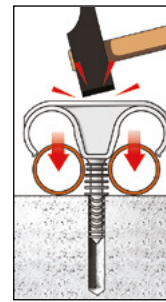

Presentar tubo y golpear.

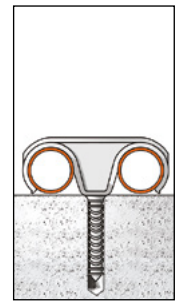

Fijación terminada.

Bolsas

FTD Gris	Precios		Envase	Embalaje	Embalaje
Ø [mm]	Código	Precio €/Bolsa	(Uds)	(Bolsas)	(Uds)
18	18FTD	6,10	6	15	90
22	22FTD	6,20	6	15	90

Clip plástico TCB

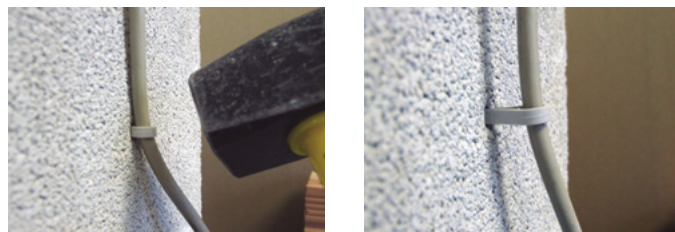

Características

- Polivalencia: dos medidas sujetan cables de 3 a 28 [mm]
- Instalación con broca de diámetro 6 [mm]
- Resistencia 30Kg.

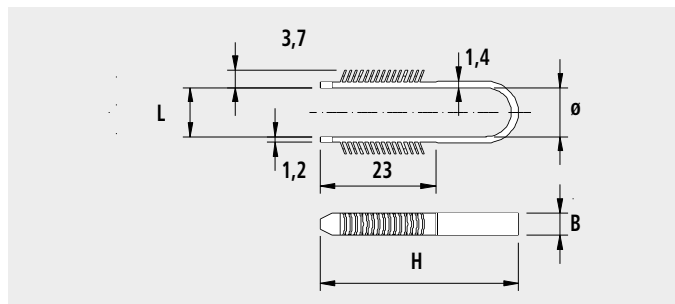

Cajas

TCB Blanco				Precios		Envase	Embalaje
Ø [mm]	H [mm]	L [mm]	B [mm]	Código	Precio €/100 u.	(Uds)	(Uds)
3-13	17,8	10,4	4,8	913TCB	22,30	200	3.600
13-28	17,8	10,4	4,8	928TCB	28,20	100	900

L = 10,4 + 3,7 x 2

Bolsas

TCB Blanco	Precios		Envase	Embalaje	Embalaje
Ø [mm]	Código	Precio €/Bolsa	(Uds)	(Bolsas)	(Uds)
3-13	13TCB	6,60	20	15	300
13-28	28TCB	4,30	10	15	150

Instalación



Taladrar con broca 6.

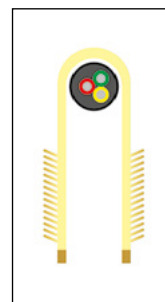

Presentar tubo y golpear.

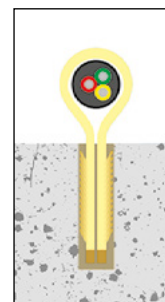

Introducir grapa en el agujero.

SUJECIÓN

Plastigrap® PLG



Características

- Punta de acero de alta tenacidad.
- Para cables y mangueras.

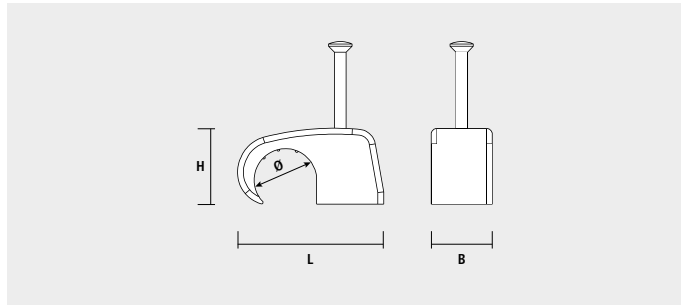

Cajas

PLG Blanco				Precios		Envase	Embalaje
Ø [mm]	H [mm]	L [mm]	B [mm]	Código	Precio €/100 u.	(Uds)	(Uds)
ø4	6,5	10,5	6,5	14PLG	7,30	500	4.500
ø5	7,5	11	6,5	15PLG	7,30	500	4.500
ø6	9	13	6,5	16PLG	7,50	500	4.500
ø7	10	13,5	6,5	17PLG	8,60	500	4.500
ø8	10,5	14	6,5	18PLG	8,70	500	4.500
ø9	13	16,5	7	19PLG	9,40	500	4.500
ø10	15	19	9	110PLG	11,00	500	4.500

PLG Negro				Precios		Envase	Embalaje
Ø [mm]	H [mm]	L [mm]	B [mm]	Código	Precio €/100 u.	(Uds)	(Uds)
ø4	6,5	10,5	6,5	46PLG	7,50	500	4.500
ø7	10	13,5	6,5	47PLG	8,60	500	4.500
ø8	10,5	14	6,5	48PLG	8,70	500	4.500
ø9	13	16,5	7	49PLG	9,40	500	4.500
ø10	15	19	9	410PLG	10,90	500	4.500

Blisters

PLG Blanco		Precios		Envase	Embalaje	Embalaje
Ø [mm]	Código	Precio €/Bolsa	(Uds)	(Blisters)	(Uds)	
ø5	415PLG	8,30	100	10	1.000	
ø6	416PLG	9,40	100	10	1.000	
ø7	417PLG	8,30	80	10	800	
ø8	418PLG	8,70	80	10	800	
ø9	419PLG	8,10	60	10	600	
ø10	4110PLG	7,60	40	10	400	

PLG Negro		Precios		Envase	Embalaje	Embalaje
Ø [mm]	Código	Precio €/Bolsa	(Uds)	(Blisters)	(Uds)	
ø6	446PLG	9,40	100	10	1.000	
ø7	447PLG	8,30	80	10	800	
ø8	448PLG	8,70	80	10	800	
ø9	449PLG	8,10	60	10	600	
ø10	4410PLG	7,60	40	10	400	

Plastigrap® multidíámetro MPLG



Características

- Con tres referencias se cubren nueve diámetros (de 4 a 14).
- Punta de acero de alta tenacidad.
- Amplia base para facilitar el montaje.

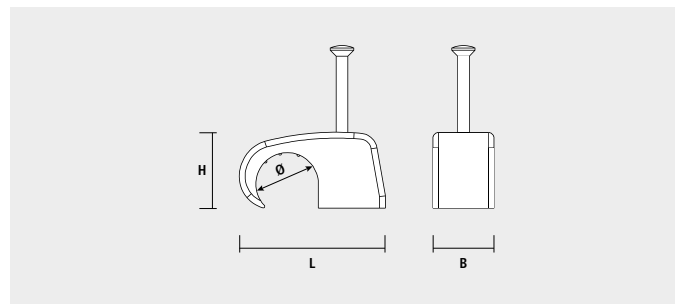
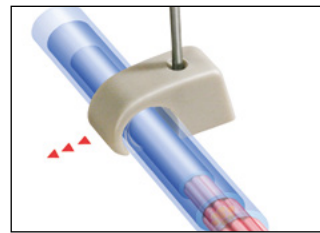

Cajas

MPLG Blanco				Precios		Envase	Embalaje
Ø [mm]	H [mm]	L [mm]	B [mm]	Código	Precio €/100 u.	(Uds)	(Uds)
4-6	7	15	7	9147MPLG	8,30	200	3200
7-9	10	20	9	9179MPLG	10,00	100	2400
10-14	13	30	10	911014MPLG	18,60	100	1800

MPLG Negro				Precios		Envase	Embalaje
Ø [mm]	H [mm]	L [mm]	B [mm]	Código	Precio €/100 u.	(Uds)	(Uds)
4-6	7	15	7	9447MPLG	8,30	200	3200
7-9	10	20	9	9479MPLG	10,00	100	2400
10-14	13	30	10	941014MPLG	18,60	100	1800

Información Técnica

Ø [mm]	Clavo [mm]	Cables
4-6	2x25	1x1 - 2x0,5 - 1x1,5, 2x0,75 - 2x1
7-9	2x35	2x1 - 2x1,5 - 2x2,5, 2x4 - 3x2,5
10-14	2x40	2x4 - 3x4 - 3x6, 4x2,5 - 4x6

Bolsas

MPLG Blanco		Precios		Envase	Embalaje	Embalaje
Ø [mm]	Código	Precio €/Bolsa	(Uds)	(Bolsas)	(Uds)	
4-6	147MPLG	3,50	25	15	375	
7-9	179MPLG	4,50	25	15	375	
10-14	11014MPLG	7,40	25	15	375	

Basebrid adhesiva **BBA**



Características

- Válida para bridas de hasta 3,6 mm de anchura (BBA19) y 4,8 mm (BBA28).
- Se pueden insertar bridas por las cuatro caras.
- Apta para pegar en cualquier superficie.

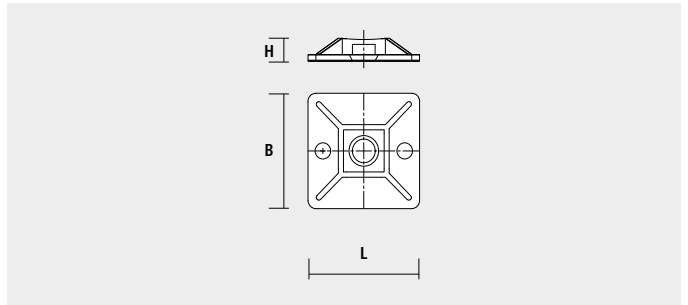

Cajas

BBA Blanco			Precios		Envase	Embalaje
H [mm]	L [mm]	B [mm]	Código	Precio €/100 u.	(Uds)	(Uds)
4	19	19	9119BBA	30,20	100	1.800
5,5	28	28	9128BBA	50,80	100	900

Bolsas

BBA Blanco	Precios		Envase	Embalaje	Embalaje
	Código	Precio €/Bolsa	(Uds)	(Bolsas)	(Uds)
20x20	119BBA	5,00	15	15	225
25x25	128BBA	4,40	10	15	150

Basebrid atornillable **BBT**



Características

- Instalación rápida con tornillo de Ø3 mm para 915BBT y tornillo de Ø6 mm para 919BBT.
- Permite bridas de 2,5 mm de ancho (915BBT) y de 9 mm de ancho (919BBT).
- Montaje de brida en una dirección.

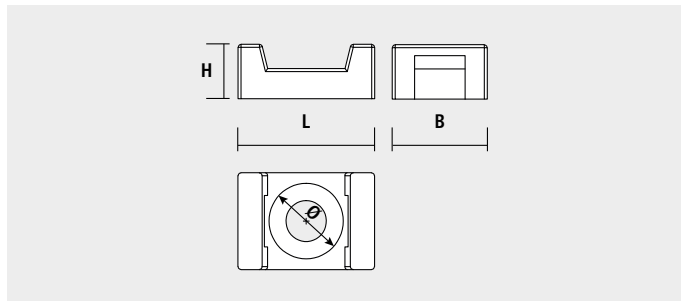

Cajas

BBT Blanco				Precios		Envase	Embalaje
Ø [mm]	H [mm]	L [mm]	B [mm]	Código	Precio €/100 u.	(Uds)	(Uds)
3,7	7	15	10	915BBT	22,70	100	3.600
6,4	10	23	16	919BBT	30,20	100	1.800

Bolsas

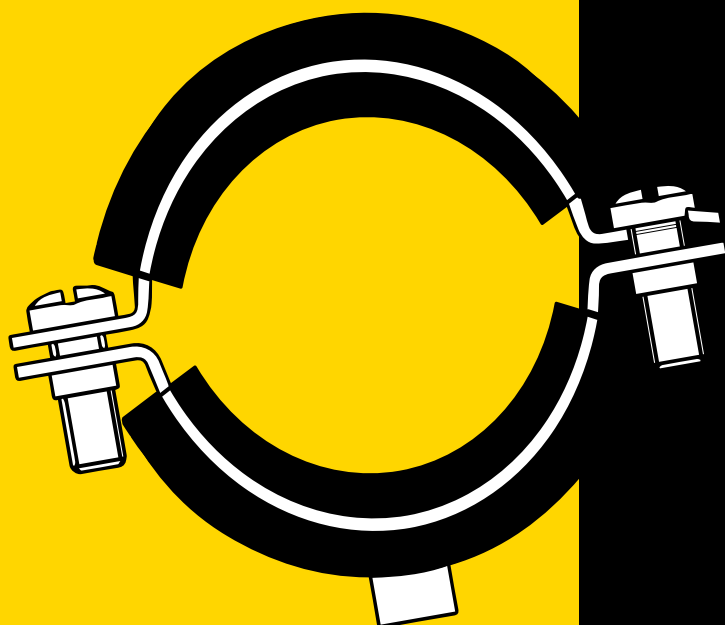

BBT Blanco	Precios		Envase	Embalaje	Embalaje
Ø [mm]	Código	Precio €/Bolsa	(Uds)	(Bolsas)	(Uds)
3	15BBT	5,00	20	15	300
6	19BBT	4,40	15	15	225



Abrazaderas metálicas

Abrazadera metálica M6 NK	147	Abrazadera reforzada isofónica M8+M10 RI	159
Abrazadera metálica M6 NKS	148	Abrazadera reforzada isofónica M8 RIEL	160
Abrazadera metálica gas M6 GNK	149	Abrazadera deslizante RID	161
Abrazadera metálica M6 L	150	Abrazadera reforzada rápida isofónica M8+M10 RIF	162
Abrazadera metálica doble M6 AD	151	Abrazadera reforzada rápida isofónica M8 RIFL	163
Abrazadera isofónica M6 LI	152	Abrazadera isofónica ventilación M8+M10 VIE	164
Abrazadera isofónica doble M6 LID	153	Abrazadera isofónica para ventilación M8 VIEL	165
Abrazadera metálica doble M6 SD	154	Abrazadera isofónica altas cargas M12+M16 RIH	166
Abrazadera metálica para cables CH	155	Abrazadera contra incendios FC	167
Abrazadera reforzada M8+M10 R	157	Abrazadera para desagües M8 D	168
Abrazadera reforzada M8 REL	158	Soporte EM	169

Selector de abrazaderas metálicas ligeras

	Abrazaderas metálicas M6			Abrazaderas Isofónicas M6		Abrazaderas plastificadas
	NK NKS	L	AD SD	LI	LID	GNK
						
Rango (mm)	12 hasta 40	6 hasta 63	12 hasta 28	12 hasta 54	12 hasta 22	10 hasta 42
Baño (Resistencia corrosión) ¹	Bicro y zincado	Bicro y zincado	Bicro	Bicro + EPDM	Bicro + EPDM	Plastificado
Resistencia a tracción recomendada (kg)	55	50	80	55	80	55
Grosor (mm)	1-1,2	1,2	Tapa: 0,8-1 Pata: 1,2-1,5	1,2	Tapa: 0,8 Pata: 1,2	1-1,2
Anchura (mm)	13	Tapa: 11-12 Pata: 12-14 s/m	12	Tapa: 11-12 Pata: 12-14 s/m	12	13
Aplicaciones	Eléctricas/Sanitarias			A.C.S / Gas/ Aire comprimido		Exteriores / Gas Ambientes corrosivos
Tapa abierta	SÍ	SÍ	NO	SÍ	NO	SÍ

¹ Cincado: 24 HNS aparición corrosión blanca, 72 HNS aparición corrosión roja.
 Bicromatado: 96 HNS aparición corrosión blanca, 288 HNS aparición corrosión roja.
 Plastificado negro epoxy/amarillo PET: 288 HNS aparición corrosión blanca, 864 HNS aparición corrosión roja.

Abrazadera metálica M6 NK



Características

- Sistema de prefijación del tubo con protuberancias de preclipado.
- Nervios de base y tapa más marcados para una mayor resistencia.
- Uña lateral para una fácil preinstalación.
- Mayor grosor de perfil 13 mm para una mayor resistencia.
- Mayor diámetro de cabeza del tornillo 9 mm, para un mejor agarre del cierre.

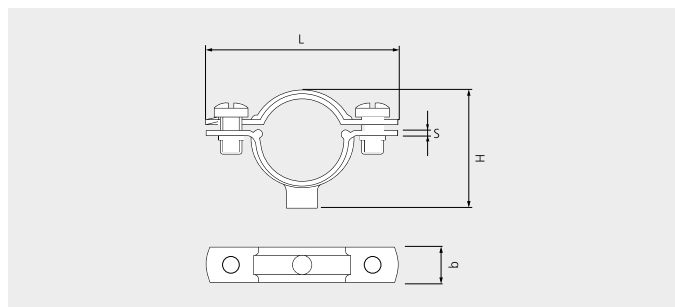

Cajas

NK M6 Bicromatado				Precios		Envase	Embalaje
Ø [mm]	S x b [mm]	H [mm]	L [mm]	Código	Precio €/100 u.	(Uds)	(Uds)
12	1 x 13	19	38	9B12NK	31,00	100	900
15	1 x 13	22	41	9B15NK	31,80	100	900
18	1 x 13	25	44	9B18NK	32,70	100	900
22	1 x 13	29	48	9B22NK	34,40	100	900
28	1,2 x 13	35,2	54	9B28NK	39,50	100	900

NK M6 Cincado				Precios		Envase	Embalaje
Ø [mm]	S x b [mm]	H [mm]	L [mm]	Código	Precio €/100 u.	(Uds)	(Uds)
16	1 x 13	23	42	916NK	32,30	100	900
16	1 x 13	23	42	916NK40	33,90	40	720
20	1 x 13	27	46	920NK	33,00	100	900
20	1 x 13	27	46	920NK30	34,70	30	540
25	1,2 x 13	32	51	925NK	36,80	100	900
25	1,2 x 13	32	51	925NK20	38,60	20	360
32	1,2 x 13	39	58	932NK	43,30	100	600
32	1,2 x 13	39	58	932NK15	45,30	15	270
40	1,2 x 13	47	66	940NK	57,00	50	450

Bolsas

NK M6 Bicromatado		Precios		Envase	Embalaje	Embalaje
Ø [mm]	Código	Precio €/Bolsa	(Uds)	(Bolsas)	(Uds)	
12	B12NK	2,40	5	15	75	
15	B15NK	2,50	5	15	75	
18	B18NK	2,50	5	15	75	
22	B22NK	2,60	5	15	75	
28	B28NK	4,40	10	15	150	

NK M6 Cincado		Precios		Envase	Embalaje	Embalaje
Ø [mm]	Código	Precio €/Bolsa	(Uds)	(Bolsas)	(Uds)	
16	16NK	2,40	5	15	75	
20	20NK	2,50	5	15	75	
25	25NK	3,60	5	15	75	
32	32NK	2,90	5	15	75	
40	40NK	3,50	6	15	90	

Información Técnica

Ø [mm]	Cargas [Kg]	Ø Tubos	
		Cobre	Plástico
12	55	12	-
15	55	15	-
16	55	-	16
18	55	18	-
20	55	-	20
22	55	22	-
25	55	-	25
28	55	28	-
32	55	-	32
40	55	-	40

Abrazadera metálica M6 NKS

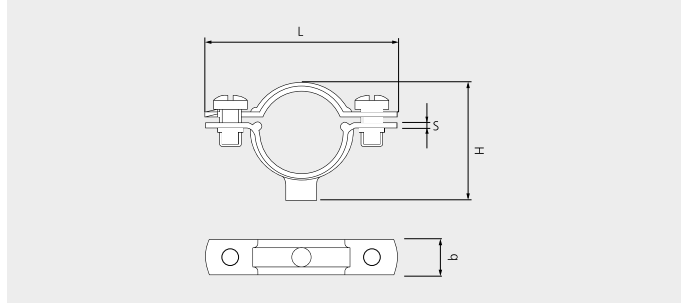

Características

- Tirafondo M6x30 incorporado.
- Sistema de prefijación del tubo con protuberancias de preclipado.
- Nervios de base y tapa más marcados para una mayor resistencia.
- Uña levantada para una fácil preinstalación.
- Mayor grosor de perfil 13 mm para una mayor resistencia.
- Mayor diámetro de cabeza del tornillo 9 mm, para un mejor agarre del cierre.

Cajas

NKS M6 Bicromatado				Precios		Envase	Embalaje
Ø [mm]	S x b [mm]	H [mm]	L [mm]	Código	Precio €/100 u.	(Uds)	(Uds)
15	1 x 13	22	41	9B15NKS	48,10	100	900
18	1 x 13	25	44	9B18NKS	48,50	50	450
22	1 x 13	29	48	9B22NKS	50,20	50	450

NKS M6 Cincado				Precios		Envase	Embalaje
Ø [mm]	S x b [mm]	H [mm]	L [mm]	Código	Precio €/100 u.	(Uds)	(Uds)
16	1 x 13	23	42	916NKS	48,20	100	900
20	1 x 13	27	46	920NKS	49,10	50	450
25	1,2 x 13	32,2	51	925NKS	50,50	50	450
32	1,2 x 13	39,2	58	932NKS	57,90	50	450

Información Técnica

Ø [mm]	Cargas [Kg]	Ø Tubos	
		Cobre	Plástico
15	55	15	-
16	55	-	16
18	55	18	-
20	55	-	20
22	55	22	-
25	55	-	25
32	55	-	32

Abrazadera metálica gas M6 GNK



Características

- Recubrimiento plástico evita la corrosión electrolítica entre cobre y acero.
- Tirafondo M6x30 incorporado.
- Sistema de prefijación del tubo con protuberancias de preclipado.
- Nervios de base y tapa más marcados para una mayor resistencia.
- Uña levantada para una fácil preinstalación.
- Mayor grosor de perfil 13 mm para una mayor resistencia.
- Mayor diámetro de cabeza del tornillo 9 mm, para un mejor agarre del cierre.

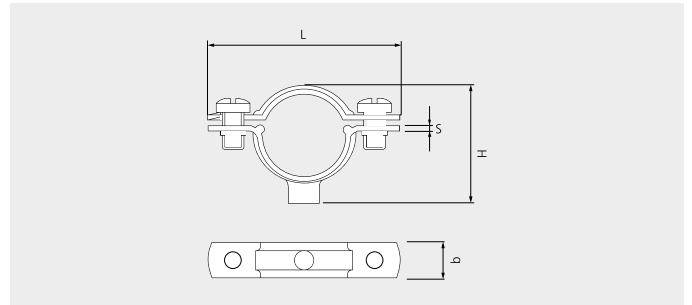

Cajas

GNK M6 Negro				Precios		Envase	Embalaje
Ø [mm]	S x b [mm]	H [mm]	L [mm]	Código	Precio €/100 u.	(Uds)	(Uds)
10	1,2 x 11/12	20	37	9N10GNK ⁽²⁾	54,30	100	900
12	1,2 x 11/12	23	40	9N12GNK ⁽²⁾	55,20	100	900
15	1 x 13	22	41	9N15GNK	61,00	50	450
18	1 x 13	25	44	9N18GNK	61,60	50	450
22	1 x 13	29	48	9N22GNK	64,30	50	450
28	1,2 x 12	42,2	61	9N28GNK ⁽²⁾	71,90	50	450
35	1,2 x 12/14	49,2	68	9N35GNK ⁽²⁾	80,20	50	450
42	1,2 x 12/14	60,7	83	9N42GNK ⁽²⁾	92,40	25	225

¹ Factor de seguridad incluido.
² Medidas que no incluyen sistema de prefijación.

GNK M6 Amarillo				Precios		Envase	Embalaje
Ø [mm]	S x b [mm]	H [mm]	L [mm]	Código	Precio €/100 u.	(Uds)	(Uds)
12	1,2 x 11/12	22,7	40	9A12GNK ⁽²⁾	60,90	100	900
15	1 x 13	22	41	9A15GNK	67,30	50	450
18	1 x 13	25	44	9A18GNK	68,20	50	450
22	1 x 13	29	48	9A22GNK	72,30	50	450
28	1,2 x 12	42,2	61	9A28GNK ⁽²⁾	79,20	50	450
35	1,2 x 12/14	49,2	68	9A35GNK ⁽²⁾	86,30	50	450

¹ Factor de seguridad incluido.
² Medidas que no incluyen sistema de prefijación.

Bolsas

GNK M6 Negro		Precios		Envase	Embalaje	Embalaje
Ø [mm]	Código	Precio €/Bolsa	(Uds)	(Bolsas)	(Uds)	(Uds)
15	N15GNK	6,10	10	15	150	150
18	N18GNK	6,20	10	15	150	150
22	N22GNK	7,00	10	15	150	150

Información Técnica

Ø [mm]	Carga [Kg]	Ø Tubos
		Cobre
10	55	10
12	55	12
15	55	15
18	55	18
22	55	22
28	55	28
35	55	35
42	55	42

Abrazadera metálica M6 L

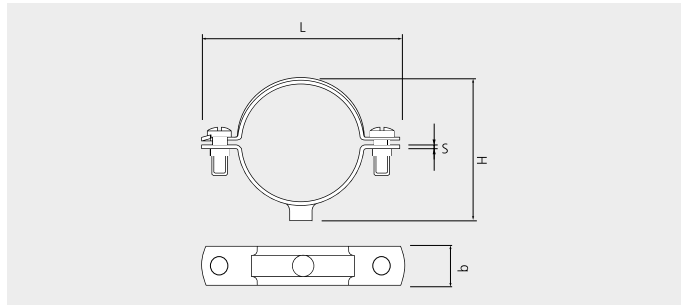

Características

- Nervio central para ofrecer una mayor resistencia.
- Permite abrir y cerrar la abrazadera sin necesidad de desenroscar totalmente el tornillo lateral.

Cajas

L M6 Bicromatado				Precios		Envase	Embalaje
Ø [mm]	S x b [mm]	H [mm]	L [mm]	Código	Precio €/100 u.	(Uds)	(Uds)
10	1,2 x 11/12	17,7	35	9B10L	29,90	100	1.800
12	1,2 x 11/12	19,7	37	9B12L	29,90	100	900
15	1,2 x 11/12	22,7	40	9B15L	30,50	100	900
18	1,2 x 11/12	25,2	43	9B18L	31,60	100	900
22	1,2 x 11/12	29,2	47	9B22L	33,20	100	900
28	1,2 x 11/12	35,2	53	9B28L	38,00	100	900
35	1,2 x 11/12	42,2	61	9B35L	46,50	50	450
42	1,2 x 11/12	49,2	68	9B42L	57,00	50	450
55	1,2 x 12/14	60,7	82,8	9B55L	68,90	25	225
63	1,2 x 12/14	69,7	90	9B63L	75,40	25	225

L M6 Cincado				Precios		Envase	Embalaje
Ø [mm]	S x b [mm]	H [mm]	L [mm]	Código	Precio €/100 u.	(Uds)	(Uds)
6	1,2 x 11/12	13,7	31	96L	29,60	100	1.800
8	1,2 x 11/12	15,7	33	98L	29,80	100	1.800
10	1,2 x 11/12	17,7	35	910L	29,90	100	1.800
12	1,2 x 11/12	19,7	37	912L	29,90	100	900
14	1,2 x 11/12	21,7	39	914L	30,40	100	900
16	1,2 x 11/12	23,7	41	916L	31,30	100	900
20	1,2 x 11/12	27,2	45	920L	31,90	100	900
25	1,2 x 11/12	32,2	51,5	925L	35,50	100	900
26	1,2 x 11/12	33,2	52	926L	36,10	100	900
32	1,2 x 11/12	39,2	57	932L	41,60	50	450
40	1,2 x 11/12	47,2	66	940L	54,90	50	450
50	1,2 x 12/14	56,7	78	950L	65,80	25	225
60	1,2 x 12/14	66,7	88	960L	71,80	25	225
63	1,2 x 12/14	69,7	90	963L	75,40	25	225

Bolsas

L M6 Bicromatado		Precios		Envase	Embalaje	Embalaje
Ø [mm]	Código	Precio €/Bolsa	(Uds)	(Bolsas)	(Uds)	(Uds)
18	B18L	1,30	10	15	150	150
28	B28L	3,80	10	15	150	150
35	B35L	2,60	5	15	75	75
42	B42L	3,20	5	15	75	75
55	B55L	4,40	5	15	75	75

L M6 Cincado		Precios		Envase	Embalaje	Embalaje
Ø [mm]	Código	Precio €/Bolsa	(Uds)	(Bolsas)	(Uds)	(Uds)
50	50L	3,40	6	15	90	90

Información Técnica

Ø [mm]	Cargas [Kg]	Ø Tubos		
		Hierro	Cobre	Plástico
6	50	-	6	-
8	50	-	8	-
10	50	1/8"	10	-
12	50	-	12	-
14	50	1/4"	-	-
15	50	-	15	-
16	50	-	-	16
18	50	3/8"	18	-
20	50	-	-	20
22	50	1/2"	22	-
25	50	-	-	25
26	50	3/4"	-	-
28	50	-	28	-
32	50	-	-	32
35	50	1"	35	-
40	50	-	-	40
42	50	1-1/4"	42	-
50	50	-	-	50
55	50	-	54	-
60	50	2"	-	60

Abrazadera metálica doble M6 AD



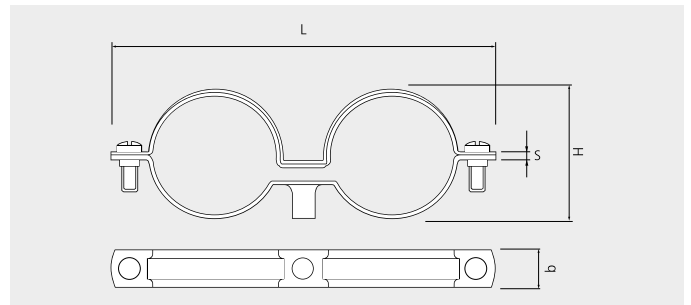

Características

- Montaje de tubos de agua o gas en paralelo.
- Recubrimiento bicromatado.



Cajas

AD M6 Bicromatado				Precios		Envase	Embalaje
Ø [mm]	S x b [mm]	H [mm]	L [mm]	Código	Precio €/100 u.	 (Uds)	 (Uds)
12	0,8/1,2 x 12	15,5	66	9B12AD	56,10	100	900
15	0,8/1,2 x 12	17,5	74	9B15AD	65,00	100	900
18	0,8/1,2 x 12	20	77	9B18AD	67,70	100	900
22	0,8/1,2 x 12	26	87	9B22AD	71,30	50	450
28	1/1,5 x 12	32,7	98	9B28AD	90,00	50	450

Bolsas

AD M6 Bicromatado		Precios		Envase	Embalaje	Embalaje
Ø [mm]	Código	Precio €/Bolsa	 (Uds)	 (Bolsas)	 (Uds)	
12	B12AD	4,50	10	15	150	
15	B15AD	4,60	10	15	150	
18	B18AD	5,00	10	15	150	
22	B22AD	6,30	10	15	150	
28	B28AD	7,80	10	15	150	

Información Técnica

Ø [mm]	Cargas [kg]	Ø Tubos
		Cobre
12	66	12
15	66	15
18	66	18
22	66	22
28	66	28

Abrazadera isofónica M6 LI

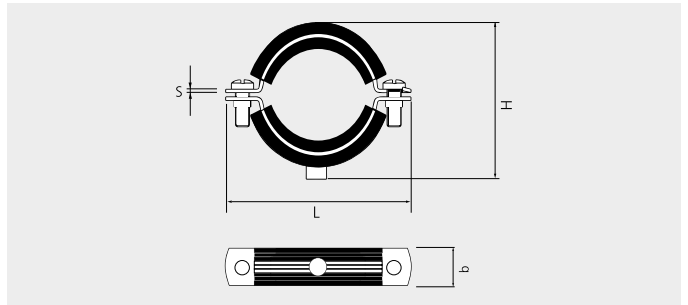

Características

- Apertura lateral con la uña levantada para facilitar la preinstalación.
- Goma isofónica de EPDM.
- Nervio central para ofrecer mayor resistencia.

Cajas

LI M6 Bicromatado				Precios		Envase	Embalaje
Ø [mm]	S x b [mm]	H [mm]	L [mm]	Código	Precio €/100 u.	(Uds)	(Uds)
12	1,2 x 11/12	23,5	41	9B12LI	36,80	100	900
15	1,2 x 11/12	25	43	9B15LI	39,00	100	900
18	1,2 x 11/12	29	47	9B18LI	42,80	100	900
22	1,2 x 11/12	33	51	9B22LI	48,30	50	450
28	1,2 x 11/12	39	57	9B28LI	53,80	50	450
35	1,2 x 11/12	47	66	9B35LI	67,10	25	225
42	1,2 x 11/12	51,5	70	9B42LI	74,20	25	225

Bolsas

LI M6 Bicromatado		Precios		Envase	Embalaje	Embalaje
Ø [mm]	Código	Precio €/Bolsa	(Uds)	(Bolsas)	(Uds)	
12	B12LI	2,60	5	15	75	
15	B15LI	2,90	5	15	75	
18	B18LI	3,20	5	15	75	
22	B22LI	3,30	5	15	75	
28	B28LI	3,40	5	15	75	
35	B35LI	4,40	5	15	75	
42	B42LI	4,70	5	15	75	

Información Técnica

Ø [mm]	Cargas [Kg]	Ø Tubos	
		Cobre	Plástico
12	55	12	-
15	55	15	-
16	55	-	16
18	55	18	-
20	55	-	20
22	55	22	-
25	55	-	25
28	55	28	-
32	55	-	32
40	55	-	40

Abrazadera isofónica doble M6 LID

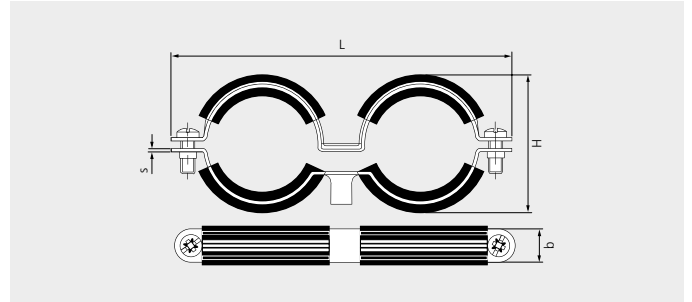
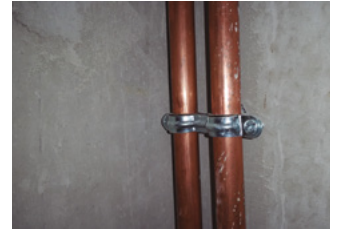

Características

- Goma isofónica de EPDM.
- Montaje de tubos en paralelo.
- Nervio central para ofrecer mayor resistencia.

Cajas

LID M6				Precios		Envase	Embalaje
Ø [mm]	S x b [mm]	H [mm]	L [mm]	Código	Precio €/100 u.	(Uds)	(Uds)
12	0,8/1,2 x 12	16	74	9B12LID	81,40	50	450
15	0,8/1,2 x 12	18	77	9B15LID	93,60	50	450
18	0,8/1,2 x 12	22	87	9B18LID	97,80	50	450
22	0,8/1,2 x 12	25	82	9B22LID	112,10	25	225

Información Técnica

Ø [mm]	Cargas [Kg]	Ø Tubos
		Cobre
12	66	12
15	66	15
18	66	18
22	66	22

Abrazadera metálica doble M6 SD

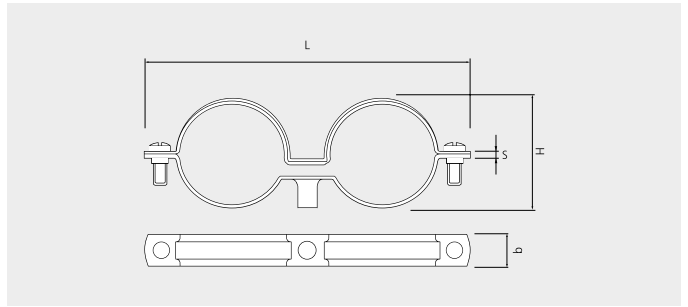

Características

- Montaje de tubos en paralelo.
- Tirafondo M6x30 incorporado.

Cajas

SD M6 Bicromatado				Precios		Envase	Embalaje
Ø [mm]	S x b [mm]	H [mm]	L [mm]	Código	Precio €/100 u.	(Uds)	(Uds)
12	0,8/1,2 x 12	15,5	66	9B12SD	71,30	50	450
15	0,8/1,2 x 12	17,5	74	9B15SD	81,40	50	450
18	0,8/1,2 x 12	20	77	9B18SD	83,60	50	450
22	0,8/1,2 x 12	26	87	9B22SD	87,60	50	450

Información Técnica

Ø [mm]	Cargas [Kg]	Ø Tubos
		Cobre
12	66	12
15	66	15
18	66	18
22	66	22

Abrazadera metálica para cables CH

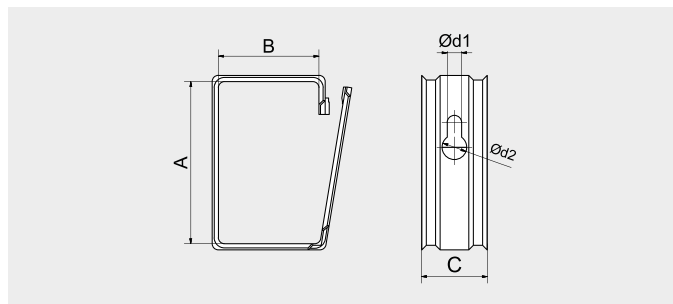
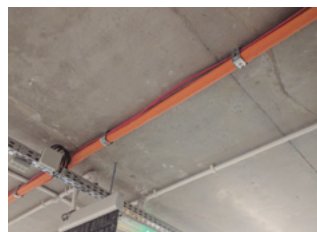

Características

- Sujeción rápida de cableado eléctrico.
- Homologado al fuego.
- Abrazadera de fácil instalación y rápido montaje con tornillo BTS-6.
- Dos posiciones de montaje: techo y pared.
- Posibilidad de instalar distintos diámetros de cable a la vez.
- Permite ampliar instalación eléctrica fácilmente.

Cajas

CH						Precios		Envase
Denom.	A [mm]	B [mm]	C [mm]	$\varnothing d1$ [mm]	$\varnothing d2$ [mm]	Código	Precio €/100 u.	Envase (Uds)
CH-55	57	33,5	32	7	12	94055CH	106,20	100
CH-80	79	49	32	7	12	95580CH	171,90	50

Cargas recomendadas F_{Rec} [kN]

Distancia entre Abrazaderas [cm]	30	40	50	60	70	80
Carga máx. rec. por abrazadera [kg] \leq	≤ 6 (1)	$\leq 4,5$	$\leq 3,6$	≤ 3	$\leq 2,6$	$\leq 2,3$

(1) La capacidad máxima de carga es de 6 kg/m. Se recomienda instalar con una separación de 30 cm a 60 cm, dependiendo de la rigidez del cable.

Selector de abrazaderas metálicas reforzadas

	R	REL	RI	RIEL	RID	RIF	RIFL	RIH	FIRCLAM®	VIE	VIEL
	Standard	Standard M8	Standard	Standard M8	Deslizante	Rápida Plus	Rápida M8	Altas Cargas	Contra incendios	Ventilación Plus	Ventilación M8
Rango	18 hasta 200	3.5 hasta 60	18 hasta 400	18 hasta 60	18 hasta 160	15 hasta 60	15 hasta 60	60 hasta 270	28 hasta 170	100 hasta 710	100 hasta 400
Manguito Roscado	M8+M10	M8	M8+M10	M8	M8+M10	M8+M10	M8	M12 RIH 60, 75, 90 M16 RIH 110, 140, 160, 220, 270	M10 FC28-FC115 M12 FC140-FC170	M8+M10	M8
Baño (Resistencia Corrosión) ¹⁾	Cincada	Cincada	Cincada	Cincada	Cincada	Cincada	Cincada	Cincada	Recubrimiento Inorgánico	Cincada	Cincada
Resistencia recomendada Tracción (Kg)	150 hasta R100 200 R110/ R200	130	150 hasta R100 200 R110/R1400	100 hasta 28 130 resto	100 hasta 50 150 resto	80	80	275 hasta 90 375 RIH 110 600 RIH 140/270	110 Kg FC 28/FC 60 125 Kg-FC 75 155 Kg-FC 90 190 Kg-FC 115 250 Kg-FC 140 330 Kg-FC 170	60 Kg hasta 450 80 Kg resto	60 Kg hasta 400
Grosor (mm)	2-2,5 s/m	1,5	1,5-2 s/m	1,5	1,2-2-2,5 s/m	1,25	1,20	2,5-4 s/m	1,2-1,5 2 s/m	1,5-2 s/m	1,5-2 s/m
Anchura (mm)	20	20	20/25 s/m	20	20/25 s/m	20	20	30-40 s/m	25-30 s/m	20-25	20-25
Aplicaciones	Eléctricas/ Desagüe	Eléctricas/ Desagüe	A.C.S /Gas/ Aire comprimido tubos enfundados	A.C.S /Gas/ Aire comprimido tubos enfundados	A.C.S Tubos enfundados	A.C.S /Gas/ Aire comprimido tubos enfundados	A.C.S /Gas/ Aire comprimido tubos enfundados	A.C.S /Gas/ Aire comprimido tubos enfundados	Instalaciones Contra- incendios y climatización contra- incendios	Instalaciones de ventilación	Instalaciones de ventilación

¹⁾ Cincado: 24 HNS aparición corrosión blanca, 72 HNS aparición corrosión roja.
 Plastificado amarillo PET: 288 HNS aparición corrosión blanca, 864 HNS aparición corrosión roja.
 Recubrimiento inorgánico: 400 HNS aparición corrosión blanca, >1000 HNS aparición corrosión roja.
 Galvanizado sendzimir: 288 HNS aparición corrosión blanca, 864 HNS aparición corrosión roja.

Abrazadera reforzada M8+M10 R



Características

- Tuerca M8+M10 con soldadura en cruz más resistente.
- Tornillo M6x20 hexagonal impronta ph+ranura.
- Arandelas impermeables.

Cajas



R M8+M10				Precios		Envase
Ø [mm]	S x b [mm]	H [mm]	L [mm]	Código	Precio €/100 u.	 (Uds)
14-18	1,8 x 20	39,5	54,5	918R	136,70	100
20-22	1,8 x 20	45,5	60,5	922R	140,40	100
25-28	1,8 x 20	50,5	65,5	928R	146,80	100
32-35	1,8 x 20	57,5	72,5	935R	155,10	100
40-42	1,8 x 20	63,5	78,5	940R	169,00	100
46-54	1,8 x 20	71,5	86,5	950R	172,10	100
57-60	1,8 x 20	78,5	93,5	960R	192,40	50
61-64	1,8 x 20	84,5	99,5	963R	199,00	50
72-76	1,8 x 20	100,5	115,5	975R	224,40	50
85-90	1,8 x 20	112,5	127,5	990R	239,80	50
97-101	1,8 x 20	125,5	140,5	9100R	255,00	50
106-112	1,8 x 20	133	148	9110R	260,00	50
123-126	2,3 x 20	151	166	9125R	324,10	50
135-140	2,3 x 20	163	178	9140R	401,60	50
158-164	2,3 x 20	187	202	9160R	437,10	40
197-200	2,3 x 20	227,5	242,5	9200R	474,30	40

Información Técnica

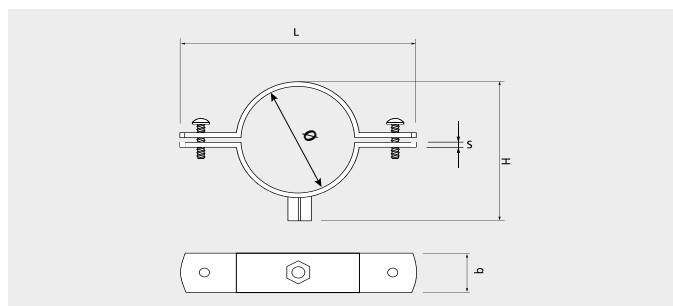
Ø [mm]	Cargas [Kg]	Ø Tubos		
		Hierro	Cobre	Plástico
14-18	150	3/8"	18	-
20-22	150	1/2"	22	-
25-28	150	3/4"	28	25
32-35	150	1"	35	32
40-42	150	1-1/4"	42	40
46-54	150	1-1/2"	54	50
57-60	150	2"	-	-
61-64	150	-	63	63
72-76	150	2-1/2"	76	75
85-90	150	3"	89	90
97-101	150	3-1/2"	-	100
106-112	200	4"	108	110
123-126	200	4-1/2"	-	125
135-140	200	5"	-	140
158-164	200	6"	-	160
197-200	200	-	-	200



Bolsas

R M8+M10		Precios		Envase	Embalaje	Embalaje
Ø [mm]	Código	Precio €/Bolsa	 (Uds)	 (Bolsas)	 (Uds)	
14-18	18REDRN	3,80	2	15	30	
20-24	22REDRN	4,10	2	15	30	
23-28	28REDRN	4,30	2	15	30	
32-35	35REDRN	4,40	2	15	30	
39-44	40REDRN	4,40	2	15	30	
44-53	50REDRN	4,70	2	15	30	
56-65	60REDRN	5,10	2	15	30	
76-84	75REDRN	6,10	2	15	30	
82-92	90REDRN	8,70	2	15	30	
107-115	110REDRN	9,30	2	15	30	
116-126	125REDRN	9,80	2	15	30	
133-140	140REDRN	10,70	2	15	30	
159-168	160REDRN	11,60	2	15	30	

SUJECIÓN

Abrazadera reforzada M8 REL

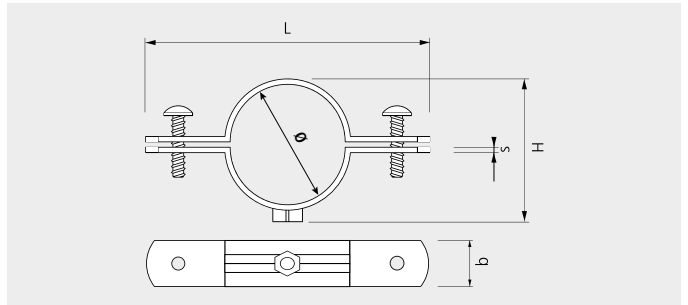

Características

- Resiste temperaturas de - 50°C a 110°C.
- Tornillo M6x20 hexagonal impronta ph+ranura.
- Cincado (5-10 µm).
- Tuerca M8.
- Arandelas imperdibles.
- Diseño con doble nervio para una mayor resistencia.

Cajas

REL M8+M10				Precios		Envase
Ø [mm]	S x b [mm]	H [mm]	L [mm]	Código	Precio €/100 u.	Uds
35	1,5 x 20	49,50	79,00	935REL	155,20	100
40	1,5 x 20	53,50	88,00	940REL	169,00	100
50	1,5 x 20	59,00	94,00	950REL	172,20	50
60	1,5 x 20	76,00	109,00	960REL	192,40	50

Información Técnica

Ø [mm]	Cargas [Kg]	Ø Tubos		
		Hierro	Cobre	Plástico
35	100	1"	35	32
40	130	1-1/4"	42	40
50	130	1-1/2"	54	50
60	150	2"	-	-

Abrazadera reforzada isofónica M8+M10 RI



Características

- Diseño con doble nervio para una mayor resistencia.
- Cargas certificadas por Applus.
- Goma EPDM resistente a los rayos UV y al agua marina.
- Resiste temperaturas de -50° a 110°.
- Tornillos más largos con cabeza alomada e impronta combi (Ranura + PH).
- Recubrimiento cincado 5-10 µm.

Cajas

RI M8+M10				Precios		Envase
Ø [mm]	S x b [mm]	H [mm]	L [mm]	Código	Precio €/100 u.	📦 (Uds)
15-19	1,5 x 20	40,5	60	918RI	177,10	100
20-24	1,5 x 20	45	62	922RI	192,40	100
23-28	1,5 x 20	49,5	70,5	928RI	195,90	100
31-36	1,5 x 20	60	79	935RI	210,90	100
38-44	1,5 x 20	64	88	940RI	232,80	100
44-50	1,5 x 20	70,5	94	948RI	251,40	100
54-58	1,5 x 20	81,5	102	954RI	266,10	50
59-65	1,5 x 20	86,5	109	960RI	283,50	50
62-67	1,5 x 20	88,5	120	963RI	302,60	50
74-80	2 x 25	102,5	133	975RI	330,70	50
83-93	2 x 25	111,5	145	990RI	362,60	50
95-103	2 x 25	116	155	9100RI	398,30	50
108-118	2 x 25	122	169	9110RI	445,50	50
121-127	2 x 25	135,5	178	9125RI	501,20	50
132-143	2 x 25	145,5	198,5	9140RI	583,90	50
159-169	2 x 25	161,5	229	9160RI	656,40	40
198-202	2 x 25	184,5	262	9200RI	774,30	40
249-254	2 x 25	275	290	9250RI	831,60	30
354-359	2,3 x 20	381	396	9355RI+	1494,90	20
399-404	2,3 x 20	427	442	9400RI+	1685,60	20

* Hasta fin de existencias.

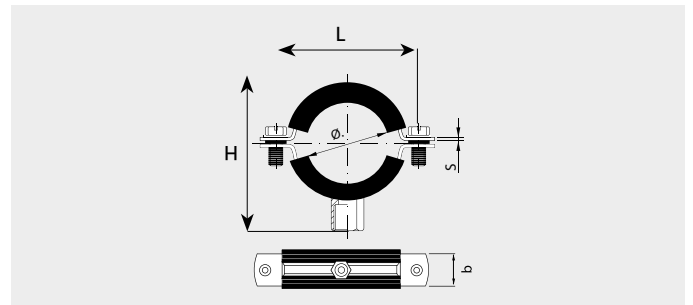
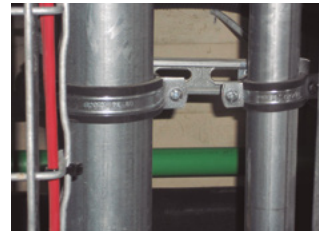

Bolsas

RI M8+M10	Precios		Envase	Embalaje	Embalaje
Ø [mm]	Código	Precio €/Bolsa	📦 (Uds)	📦 (Bolsas)	📦 (Uds)
15-19	18RIEDRN	5,00	2	15	30
20-24	22RIEDRN	5,60	2	15	30
23-28	28RIEDRN	5,80	2	15	30
31-36	35RIEDRN	6,10	2	15	30
38-44	40RIEDRN	7,20	2	15	30
44-50	50RIEDRN	7,30	2	15	30
59-65	60RIEDRN	7,70	2	15	30
74-80	75RIEDRN	8,70	2	15	30
83-93	90RIEDRN	12,30	2	15	30
108-118	110RIEDRN	13,70	2	15	30
132-143	140RIEDRN	15,40	2	15	30

Información Técnica

Ø [mm]	Cargas [Kg]	Ø Tubos		
		Hierro	Cobre	Plástico
15-19	80	3/8"	18	16
20-24	80	1/2"	22	20
23-28	80	3/4"	28	25
31-36	100	1"	35	32
38-44	100	1-1/4"	42	40
44-50	100	1-1/2"	-	50
54-58	100	-	54	-
59-65	100	2"	63	63
62-67	100	-	63	63
74-80	150	2-1/2"	76	75
83-93	150	3"	89	90
95-103	150	3-1/2"	-	-
108-118	150	4"	108	110
121-127	150	4-1/2"	-	125
132-143	150	5"	-	-
159-169	150	6"	159	160
198-202	150	-	-	200
249-254	200	-	-	250
299-314	200	-	-	-
314-319	200	-	-	315
354-359	200	-	-	-
399-404	200	-	-	400

SUJECIÓN

Abrazadera reforzada isofónica M8 RIEL

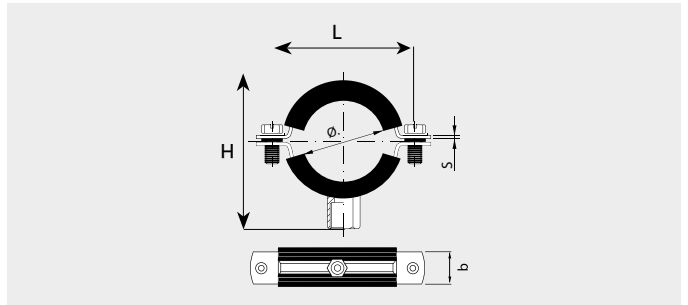
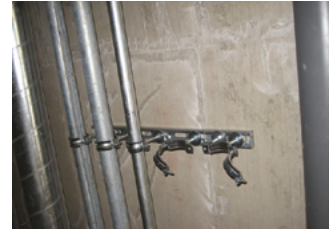

Características

- Diseño con doble nervio para una mayor resistencia.
- Cargas certificadas por Applus.
- Goma EPDM resistente a los rayos UV y al agua marina.
- Resistente temperaturas de -50 °C a 110 °C.
- Tornillos más largos, cabeza alomada e impronta combi (ranura+PH).
- Recubrimiento cincado 5-10 µm.
- Tuerca M8.

Cajas

RIEL M8				Precios		Envase
Ø [mm]	S x b [mm]	H [mm]	L [mm]	Código	Precio €/100 u.	 (Uds)
15-19	1,5 x 20	29	60	918RIEL	150,70	100
20-24	1,5 x 20	33,5	62	922RIEL	163,50	100
23-28	1,5 x 20	39	70,5	928RIEL	166,40	100
31-36	1,5 x 20	49,5	79	935RIEL	179,30	100
38-44	1,5 x 20	53,5	88	940RIEL	197,80	100
44-50	1,5 x 20	59	94	948RIEL	213,60	100
54-58	1,5 x 20	67,5	102	954RIEL	222,80	50
59-65	1,5 x 20	76	109	960RIEL	240,90	50

Información Técnica

Ø [mm]	Cargas [Kg]	Ø Tubos		
		Hierro	Cobre	Plástico
15-19	80	3/8"	18	16
20-24	80	1/2"	22	20
23-28	80	3/4"	28	25
31-36	80	1"	35	32
38-44	100	1-1/4"	42	40
44-50	100	1-1/2"	-	50
54-58	100	-	54	-
59-65	100	2"	63	63

Abrazadera deslizante RID

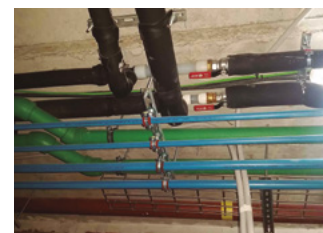

Características

- Goma TPE con felpa en la parte interior, permitiendo que el tubo se deslice.
- Fácil y rápida de montar gracias a la apertura lateral, excepto medidas 200 y 250 mm de diámetro.
- Arandelas plásticas que permiten una instalación como punto fijo o punto deslizante.
- Recubrimiento cincado 5-10 µm.
- Abrazadera con nervio de refuerzo.
- Manguito soldado de M8+M10.

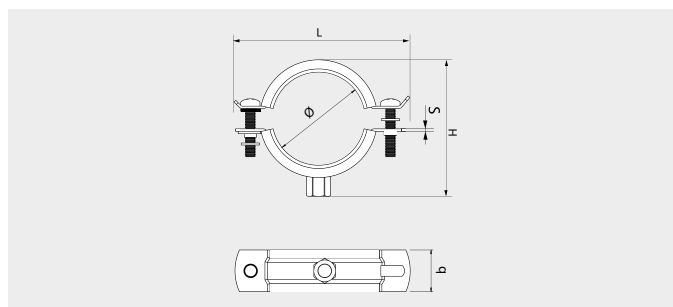

Cajas

RID M8+M10				Precios		Envase
Ø [mm]	S x b [mm]	H [mm]	L [mm]	Código	Precio €/100 u.	Uds
15-19	1,2 x 20	42	58	918RID	249,60	100
20-23	1,2 x 20	44	62	922RID	261,70	100
26-30	1,2 x 20	51	69	928RID	277,60	100
31-36	1,2 x 20	56	74	935RID	307,10	100
40-46	1,2 x 20	65	84	942RID	331,30	100
48-53	1,2 x 20	72	94	948RID	357,40	50
54-59	1,2 x 20	80	105	954RID	370,60	50
60-64	1,2 x 20	88	110	960RID	416,60	50
72-83	2 x 25	104	135	975RID	551,10	50
87-92	2 x 25	120	145	990RID	607,80	50
102-116	2 x 25	126	157	9110RID	697,50	50
124-130	2 x 25	132	157	9125RID	821,60	50
159-168	2,5 x 25	162	195	9160RID	1014,70	25
198 - 202	2 x 25	184,5	262	9200RID	1196,30	10
249 - 254	2 x 25	275	290	9250RID	1279,90	10

Información Técnica

Ø [mm]	Cargas [Kg]	Ø Tubos		
		PPR	CPVC [mm]	CPVC [Pulg]
15-19	160	16	15,9	1/2"
20-23	160	20	22,2	3/4"
26-30	160	25	28,6	1
31-36	160	32	34,9	1 1/4"
40-46	160	40	41,3	1 1/2"
48-53	160	50	54	2"
54-59	160	54	-	-
60-64	160	60	60,3	2"
72-83	160	75	73	2 1/2"
87-92	160	90	88,9	3"
102-116	250	110	114	4"
124-130	250	125	-	-
159-168	250	160	168	6"
198 - 202	250	200	-	-
249 - 254	250	250	-	-

⁽¹⁾ Factor de seguridad incluido.
⁽²⁾ Depende de la varilla utilizada.

Abrazadera reforzada rápida isofónica M8+M10 RIF

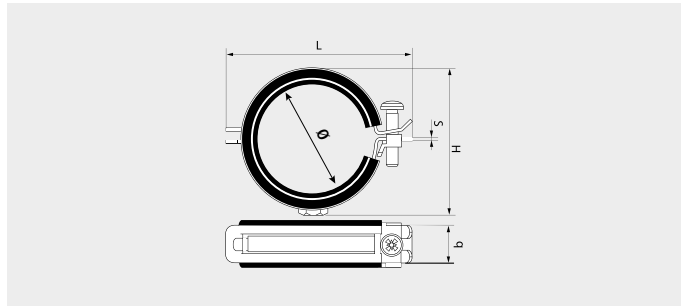
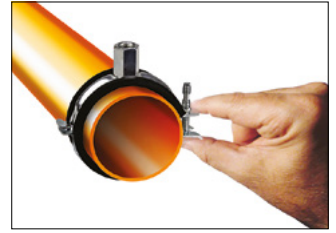

Características

- Sistema de cierre por basculación que permite cerrarla con una sola mano y montaje frontal.
- Abrazadera con nervio de refuerzo.
- Tornillo imperdible.
- EPDM resistente a los rayos ultravioletas UV y al agua marina.
- Resistente temperaturas de -50 °C a 110 °C.
- Recubrimiento cincado 5-10 µm.

Cajas

RIF M8				Precios		Envase
Ø [mm]	S x b [mm]	H [mm]	L [mm]	Código	Precio €/100 u.	 (Uds)
15	1,25/1,20 x 20	46	45	915RIF	98,40	25
18	1,25/1,20 x 20	48	47	918RIF	105,70	25
22	1,25/1,20 x 20	54	53	922RIF	114,90	20
28	1,25/1,20 x 20	60	59	928RIF	125,70	25
35	1,25/1,20 x 20	64	65	935RIF	140,40	25
40	1,25/1,20 x 20	72	73	940RIF	160,30	25
48	1,25/1,20 x 20	81	80	948RIF	177,10	20
60	1,25/1,20 x 20	95	94	960RIF	192,40	10

Información Técnica

Ø [mm]	Cargas [Kg]	Ø Tubos		
		Hierro	Cobre	Plástico
15	80	1/4"	15	-
18	80	3/8"	18	16
22	80	1/2"	22	20
28	80	3/4"	28	25
35	80	1"	35	32
40	80	1-1/4"	42	40
48	80	1-1/2"	54	50
60	80	2"	-	63

Abrazadera reforzada rápida isofónica M8 RIFL



Características

- Sistema de cierre por basculación que permite cerrarla con una sola mano y montaje frontal.
- Abrazadera con nervio de refuerzo.
- Tornillo imperdible.
- Goma EPDM gruesa, aísla e insonoriza, según norma DIN 4109.
- EPDM resistente a los rayos ultravioletas UV y al agua marina.
- Resistente temperaturas de -50 °C a 110 °C.
- Recubrimiento cincado 5-10 µm.
- Tuerca M8.

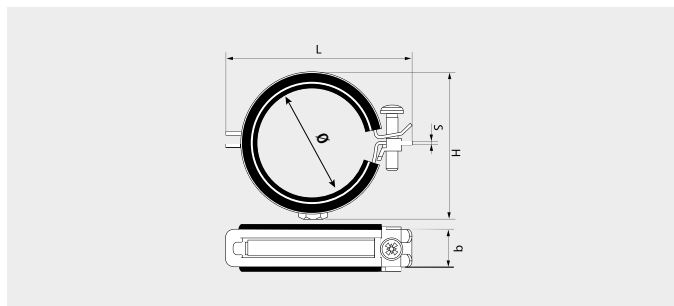

Cajas

RIFL M8				Precios		Envase
Ø [mm]	S x b [mm]	H [mm]	L [mm]	Código	Precio €/100 u.	Uds
15	1,25/1,20 x 20	38	45	915RIFL	83,60	100
18	1,25/1,20 x 20	40	47	918RIFL	89,80	100
22	1,25/1,20 x 20	46	53	922RIFL	97,70	100
28	1,25/1,20 x 20	52	59	928RIFL	106,80	100
35	1,25/1,20 x 20	58	65	935RIFL	119,40	100
40	1,25/1,20 x 20	66	73	940RIFL	136,40	100
48	1,25/1,20 x 20	73	80	948RIFL	150,70	50
60	1,25/1,20 x 20	87	94	960RIFL	163,50	50

Información Técnica

Ø [mm]	Cargas [Kg]	Ø Tubos		
		Hierro	Cobre	Plástico
15	80	1/4"	15	-
18	80	3/8"	18	16
22	80	1/2"	22	20
28	80	3/4"	28	25
35	80	1"	35	32
40	80	1-1/4"	42	40
48	80	1-1/2"	54	50
60	80	2"	-	63

SUJECIÓN

Abrazadera isofónica ventilación M8 + M10 VIE

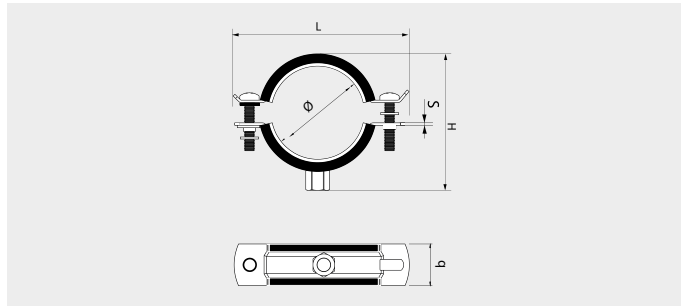

Características

- Goma EPDM más gruesa, aísla e insonoriza, según norma DIN 4109.
- EPDM resistente a los rayos ultravioletas UV y al agua.
- EPDM con resistencia al fuego B2.
- Fácil instalación gracias a la amplia apertura de la abrazadera.
- Tornillos más largos, cabeza alomada e impronta combi (ranura-PH).
- Resistente temperaturas de -50 °C a 110 °C.
- Recubrimiento cincado 5-10 µm.
- Tuerca M8 + M10.

Cajas

VIE M8+M10				Precios		Envase
Ø [mm]	S x b [mm]	H [mm]	L [mm]	Código	Precio €/100 u.	(Uds)
315	2x25	330	372	9315VIE	937,20	25
355	2x25	370	412	9355VIE	1281,40	25
400	2x25	415	457	9400VIE	1444,80	25
450	2x25	465	520	9450VIE	1601,00	20
500	2x25	515	565	9500VIE	2011,50	20
560	2x25	575	625	9560VIE	2224,00	20
630	2x25	645	696	9630VIE	2450,60	20
710	2x25	725	776	9710VIE	2855,10	20
800	2x25	815	866	9800VIE	3167,20	10

Información Técnica

Ø [mm]	Cargas [Kg]
315	60
355	60
400	60
450	80
500	80
560	80
630	80
710	80
800	80

Abrazadera isofónica ventilación M8 VIEL

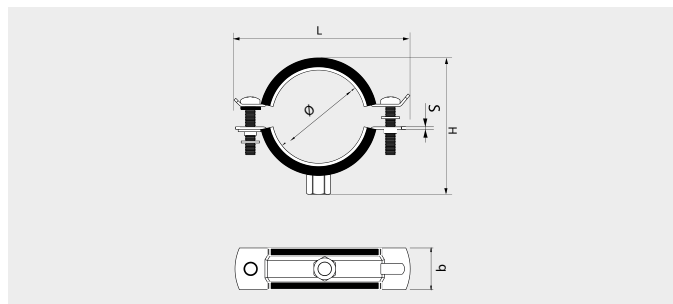

Características

- Goma EPDM más gruesa, aísla e insonoriza, según norma DIN 4109.
- EPDM resistente a los rayos ultravioletas UV y al agua.
- EPDM con resistencia al fuego B2.
- Fácil instalación gracias a la amplia apertura de la abrazadera.
- Tornillos más largos, cabeza alomada e impronta combi (ranura-PH).
- Resistente temperaturas de -50 °C a 110 °C.
- Recubrimiento cincado 5-10 µm.
- Tuerca M8.

Cajas

VIEL M8+M10				Precios		Envase
Ø [mm]	S x b [mm]	H [mm]	L [mm]	Código	Precio €/100 u.	Uds
100	1,5x20	99,5	148	9100VIEL	290,30	50
125	1,5x20	125,5	179	9125VIEL	365,40	25
160	1,5x20	160,5	215	9160VIEL	478,30	25
200	1,5x20	198,5	261	9200VIEL	564,20	25
250	2x25	258,5	305	9250VIEL	605,00	25
300	2x25	303,5	357	9300VIEL	693,90	25
315	2x25	318,5	372	9315VIEL	796,60	25
355	2x25	358,5	412	9355VIEL	1089,20	25
400	2x25	403,5	457	9400VIEL	1227,90	25

Información Técnica

Ø [mm]	Cargas [Kg]
100	60
125	60
160	60
200	60
250	60
300	60
315	60
355	60
400	60

Abrazadera isofónica altas cargas M12 + M16 RIH

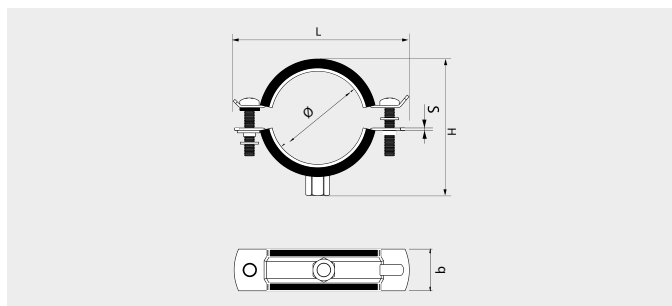

Características

- Abrazaderas grandes cargas de \varnothing 60 a 270 [mm]
- Goma EPDM aísla e insonoriza, Norma 4109.
- Resistente a los rayos UV y al agua marina.
- Resiste temperaturas de - 50°C a 110°C.
- Homologación al fuego B2 según Norma DIN 4102.
- Cincado (5-10 μ m).
- Tuerca soldada, M12, M16 según medida.

Cajas

RIH M12+M16				Precios		Envase
\varnothing [mm]	S x b [mm]	H [mm]	L [mm]	Código	Precio €/100 u.	(Uds)
60	2,5x30	12,4	47	960RIH	743,70	50
75	3x30	152,5	57	975RIH	872,20	50
90	3x30	163,5	63	990RIH	977,90	50
110	3x30	190	75	9110RIH	1077,80	25
140	4x40	234	90	9140RIH	2118,70	20
160	4x40	257	103	9160RIH	2326,60	10
220	4x40	310	128	9220RIH	3174,60	10
270	4x40	371	160	9270RIH	4241,40	10

Información Técnica

\varnothing [mm]	Cargas [Kg]
60	275
75	275
90	275
110	375
140	600
160	600
220	600
270	600
400	600

Abrazadera contra incendios

FC



*En combinación con SAP

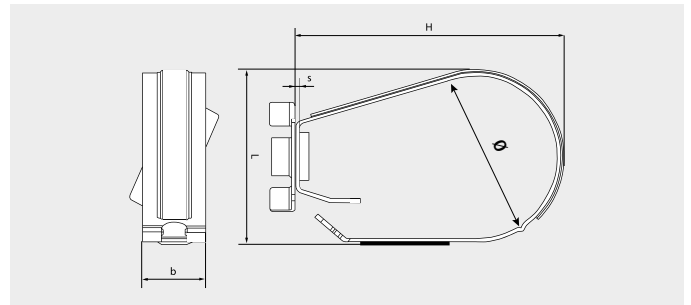

Características

- Palomilla para regulación manual.
- Tuerca M10 (5" y 6" tuerca M12).
- Cierre rápido.
- Reforzada con nervio central.
- Recubrimiento orgánico. Resistencia 4 veces superior al cincado tradicional.

Cajas

FC				Precios		Envase
Ø [mm]	S x b [mm]	H [mm]	L [mm]	Código	Precio €/100 u.	(Uds)
28	1,2 x 25	65,9	18,9	928FC	204,10	100
35	1,2 x 25	69,4	22,4	935FC	215,10	100
40	1,2 x 25	78,4	27,4	940FC	231,10	100
50	1,2 x 25	89,4	30,4	950FC	245,70	50
60	1,5 x 25	105,5	36,5	960FC	307,00	25
75	1,5 x 25	128	44	975FC	350,40	25
90	1,5 x 25	149,5	50,5	990FC	377,40	25
115	2 x 25	183	64	9115FC	545,40	15
140	2 x 30	211	77	9140FC*	726,10	10

* Hasta fin de existencias.

Información Técnica

Ø [mm]	Cargas [Kg]	Ø Tubos
		Hierro
28	110	3/4"
35	110	1"
40	110	1-1/4"
50	110	1-1/2"
60	110	2"
75	125	2-1/2"
90	155	3"
115	190	4"
140	250	5"

Instalación



Colocar el tubo



Presionar lateralmente



Regular la altura mediante la tuerca M10.

Manipulación



Introducir un destornillador



Realizar palanca

Abrazadera para desagües M8 D

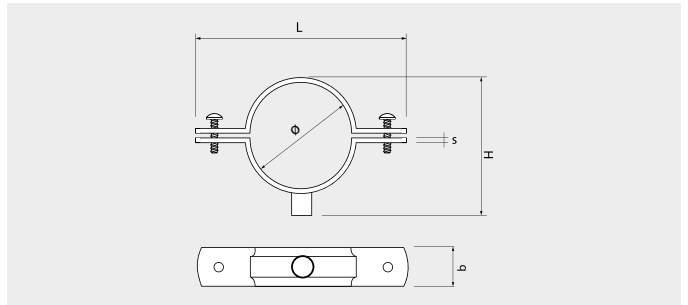

Características

- Galvanizado sendzimir.
- Tornillos y tuercas imperdibles.
- Tornillo con cabeza hexagonal e impronta PZ+ranura.
- Tuerca M8.

Cajas

D M8				Precios		Envase
Ø [mm]	S x b [mm]	H [mm]	L [mm]	Código	Precio €/100 u.	(Uds)
50	0,8x28	67	106	950D	187,80	50
60	0,8x28	77	116	960D	191,40	50
75	0,8x28	92	131	975D	212,80	50
80	0,8x28	97	136	980D	214,60	50
90	0,8x28	107	146	990D	237,80	50
100	0,8x28	117	156	9100D	239,70	50
110	0,8x28	127	166	9110D	248,60	50
125	0,8x28	142	181	9125D	278,90	50
150	0,8x28	167	206	9150D	345,10	50
160	1x28	177	216	9160D	387,90	50
200	1x28	217	256	9200D	480,90	50
250	1x28	267	306	9250D	656,10	25

Unitario

D M8	Precios		Envase	Embalaje
Ø [mm]	Código	Precio €/Bolsa	(Cajas)	(Uds)
90	90D	2,10	1	50
100	110D	2,40	1	50
125	125D	2,60	1	50
160	160D	3,50	1	50
200	200D	4,40	1	50

Información Técnica

Ø [mm]	Cargas [Kg]	Ø Tubos
		PVC
50	110	50
60	110	60
75	110	75
80	110	-
90	110	90
100	110	-
110	110	110
125	110	125
150	110	-
160	110	160
200	110	200
250	110	250

Soporte EM





Características

- Reforzado con nervios en toda su estructura.
- Colisos para facilitar su colocación.
- Espárrago M8 x 15 soldado.
- Regulable en altura, permite salvar irregularidades.
- Permite empotramiento.



Cajas

EM	Precios		Envase	Embalaje
Código	Precio €/100 u.	 (Uds)	 (Uds)	 (Uds)
98EM	119,90	25	225	225

Grapas y bridas metálicas



Sistema Multigrap GMI/TMG/SMI	172
Grapa metálica F	173
Grapa metálica U	174
Abrazadera sin fin SF	175
Brida flejinox FJX	176
Hebilla flejinox HFX	177
Grapa flejinox GFX	177
Flejadora tornillo FTLL	178
Flejadora palanca FPAL	178

Hebilla inox UAX	179
Cintapolo CA	179
Clip de viga alambre CAL	180
Clip de viga brida CBR	181
Clip de viga varilla CVA	182
Clip de viga abrazadera CAB	183
Clip de viga multifuncional CMV	184
Clip de viga para cable CC	185
Pinza a viga PMV	186

Sistema Multigrap

GMI / TMG / SMI

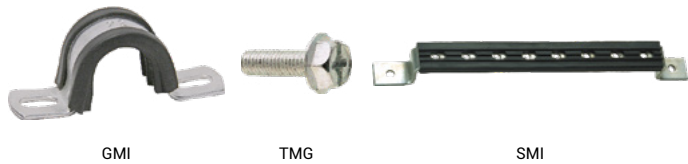

GMI

TMG

SMI

Características GMI

- Goma EPDM, aísla e insonoriza.
- Permite el montaje en paralelo.
- Agujero \varnothing 7x12 [mm]

Características SMI

- Soporte isofónico con goma de EPDM que aísla e insonoriza.
- Pensado para peinados de tubos.
- Los agujeros para fijar el soporte son de diámetro 6,5 mm y los agujeros de la zona longitudinal son de M6 para fijar con tornillo TMG.

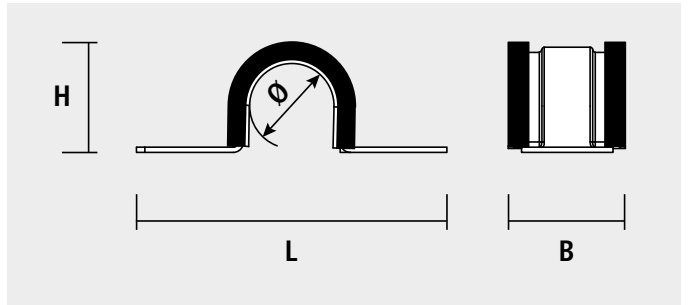

Cajas

GMI				Precios		Envase	Embalaje
\varnothing [mm]	L [mm]	H [mm]	B [mm]	Código	Precio €/100 u.	(Uds)	(Uds)
15	68	22	23	915GMI	82,20	50	450
18	69	25	23	918GMI	87,50	50	450
22	69	29	23	922GMI	94,60	50	450
28	93	35	23	928GMI	109,40	50	300
35	93	42	23	935GMI	125,80	50	300
42	91	49	23	942GMI	147,00	25	225
54	120	61	23	954GMI	184,20	25	150
60	119	67	23	960GMI	198,40	25	-
90	138	97	23	990GMI*	219,00	25	-

* Hasta agotar existencias.

TMG		Precios		Envase	Embalaje
Rosca	Código	Precio €/100 u.	(Uds)	(Uds)	
M6x15	9615TMG	9,90	100	4.000	

SMI		Precios		Envase
\varnothing [mm]	Longitud total [mm]	Código	Precio €/100 u.	(Uds)
SM-3	140	93SMI	412,80	50
SM-4	165	94SMI	471,60	50
SM-5	190	95SMI	524,10	50
SM-6	215	96SMI	583,20	25
SM-7	240	97SMI	674,80	25
SM-8	265	98SMI	714,20	25
SM-9	290	99SMI	786,10	25
SM-10	315	910SMI	838,50	25
SM-11	340	911SMI	904,20	25
SM-13	390	913SMI*	1041,70	25
SM-14	415	914SMI*	1094,00	25
SM-16	465	16SMI*	1192,20	10

* Hasta agotar existencias.

Instalación

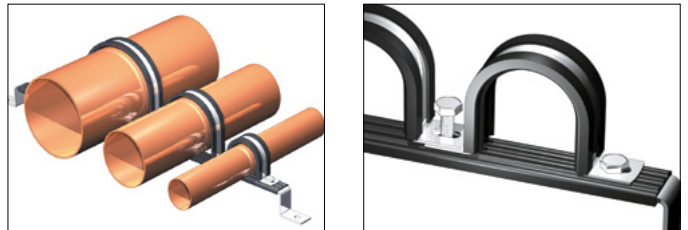

Información Técnica

\varnothing [mm]	Cargas [Kg]	\varnothing Tubos		Números agujeros SMI
		Cobre	Plástico	
15	240	-	15	3
18	240	3/8"	18	3
22	240	1/2"	22	3
28	240	3/4"	28	4
35	240	1"	35	4
42	240	1 1/4"	42	4
54	240	-	54	4
60	240	2"	64	5
90	240	3"	89	5

Grapa metálica F



Características

- Reforzada con dos nervios hasta la base.
- Agujero de 6,5 mm de diámetro.
- Acero cincado de alta resistencia a la corrosión.

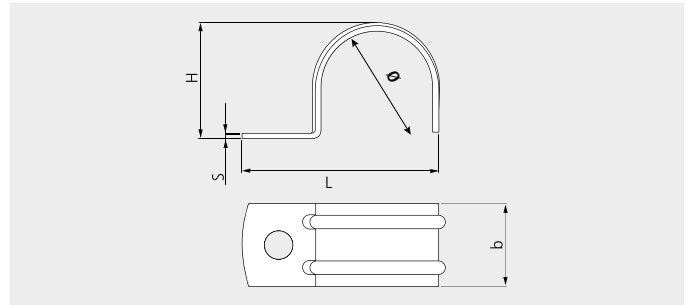

Cajas

F				Precios		Envase	Embalaje
Ø [mm]	S x b [mm]	H [mm]	L [mm]	Código	Precio €/100 u.	(Uds)	(Uds)
6	0,8 x 12	7,40	21,8	96F	9,20	100	4.000
8	0,8 x 12	9,4	23,8	98F	9,40	100	4.000
10	0,8 x 12	11,4	25,8	910F	10,60	100	1.800
12	0,8 x 12	13,4	27,8	912F	11,60	100	1.800
14	1 x 15	15,6	31,5	914F	13,00	100	1.800
16	1 x 15	17,6	33,5	916F	13,60	100	1.800
18	1 x 15	19,6	35,5	918F	15,70	100	900
20	1,2 x 18	21,9	38,7	920F	18,10	100	900
20	1,2 x 18	21,9	38,7	920F50	18,60	50	900
22	1,2 x 18	23,9	40,7	922F	20,30	100	900
25	1,2 x 18	26,9	43,7	925F	21,00	100	900
25	1,2 x 18	26,9	43,7	925F40	21,90	40	720
26	1,2 x 18	27,9	44,7	926F	22,20	100	900
28	1,2 x 18	29,9	46,7	928F	24,10	100	900
32	1,5 x 20	34,3	53,5	932F	36,70	100	600
32	1,5 x 20	34,3	53,5	932F20	38,20	20	360
40	1,5 x 20	42,3	61,5	940F	45,60	50	450
50	1,5 x 20	52,3	71,5	950F	70,20	50	450
63	1,5 x 20	65,3	84,5	963F	59,70	25	225

Bolsas

F	Precios		Envase	Embalaje	Embalaje
Ø [mm]	Código	Precio €/Bolsa	(Uds)	(Bolsas)	(Uds)
16	16F	3,20	20	15	300
18	18F	3,20	20	15	300
20	20F	3,50	20	15	300
22	22F	3,20	15	15	225
25	25F	3,40	15	15	225
28	28F	3,70	15	15	225
32	32F	4,90	15	15	225
40	40F	3,20	6	15	90

Información Técnica

Ø [mm]	Cargas [Kg]	Ø Tubos	
		Hierro	Plástico
6	12	-	-
8	12	-	-
10	12	1/8"	-
12	12	-	-
14	15	1/4"	-
16	15	-	16
18	15	3/8"	-
20	18	-	20
22	18	1/2"	-
25	18	-	25
26	18	3/4"	-
28	18	-	-
32	20	1"	32
40	20	-	40
50	20	-	50
63	20	-	63

Grapa metálica U

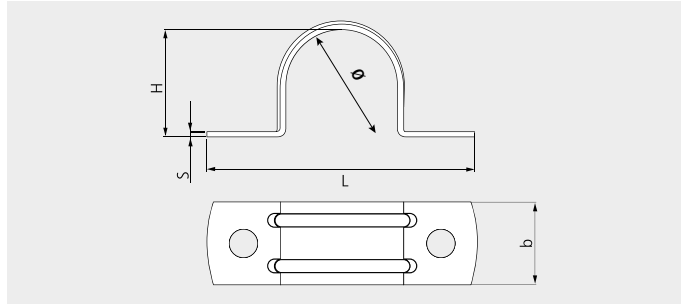

Características

- Nervio de refuerzo hasta la base.
- Agujero de 6,5 mm de diámetro.
- Acero cincado de alta resistencia a la corrosión.

Cajas

U				Precios		Envase	Embalaje
Ø [mm]	S x b [mm]	H [mm]	L [mm]	Código	Precio €/100 u.	(Uds)	(Uds)
16	1,5 x 20	19,10	52	916U	18,90	100	900
20	1,5 x 20	23,1	56	920U	22,30	100	900
22	1,5 x 20	25,3	62	922U	25,10	100	900
25	1,5 x 20	28,3	68	925U	31,60	100	900
28	1,5 x 20	31,3	72	928U	33,80	100	900
32	1,5 x 20	35,3	84	932U	37,30	100	600
40	1,5 x 20	43,7	94	940U	53,10	50	450
50	1,5 x 20	53,7	107	950U	68,80	25	225
63	1,5 x 20	66,7	20	963U	101,00	25	225

Bolsas

U		Precios		Envase	Embalaje	Embalaje
Ø [mm]	Código	Precio €/Bolsa	(Uds)	(Bolsas)	(Uds)	
16	16U	3,60	12	15	180	
20	20U	3,80	12	15	180	
25	25U	3,50	6	15	90	
32	32U	4,50	6	15	90	
40	40U	3,40	4	15	60	

Información Técnica

Ø [mm]	Cargas [Kg]	Ø Tubos	
		Hierro	Plástico
16	30	-	16
20	30	-	20
22	35	1/2"	-
25	35	-	25
28	35	3/4"	-
32	35	1"	32
40	40	-	40
50	40	-	50
63	40	2"	63

Abrazadera sin fin SF

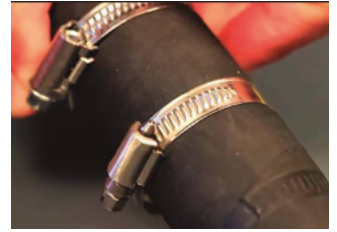

Características

- Bordes redondeados para evitar el corte de la manguera o tubo.
- Par de apriete de 2,5 kg/cm y 3kg/cm.

Cajas

SF				Precios		Envase	Embalaje
Ø [mm]	Grosor [mm]	Ancho [mm]	Par apriete [Kg/cm]	Código	Precio €/100 u.	(Uds)	(Uds)
10-16	0,8	9	2,5	910SF	81,90	100	900
12-20	0,8	9	2,5	912SF	83,80	100	900
15-25	0,8	9	2,5	915SF	92,50	100	900
20-32	0,8	9	3	920SF	101,40	100	900
25-40	0,8	9	3	925SF	109,20	100	600
32-50	0,8	9	3	932SF	120,90	100	600
40-60	0,8	9	3	940SF	136,60	100	-
50-70	0,8	9	3	950SF	148,10	50	300
90-110	0,8	9	3	990SF	218,00	25	150
110-120	0,8	9	3	9100SF	235,70	25	150
130-150	0,8	9	3	9130SF	245,40	25	-

Bolsas

SF	Precios		Envase	Embalaje	Embalaje
Ø [mm]	Código	Precio €/Bolsa	(Uds)	(Bolsas)	(Uds)
10-16	10SF	5,10	6	15	90
15-25	15SF	5,70	6	15	90
20-32	20SF	5,80	6	15	90
25-40	25SF	6,10	6	15	90
32-50	32SF	8,40	6	15	90
40-60	40SF	3,60	2	15	30

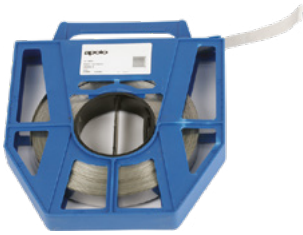

Brida flejinox FJX



Características

- Acero Inoxidable A2 (AISI 304).
- El fleje se adapta a cualquier forma de poste y tipo de material (hierro, hormigón, etc.).
- Fácil montaje.
- Permite instalación 1 o 2 vueltas (doble resistencia).
- Fleje laminado en frío de superficie muy pulida, cantos redondeados y sin rebabas para evitar cortes en las manos durante la instalación.

Cajas

FJX			Precios		Envase	Embalaje
	Carga máx. aplic. 1 vuelta [kg]	Carga máx. aplic. 2 vueltas [kg]	Código	Precio €/Rollo	 (Uds)	 (Uds)
10x0,4	160	320	X1004FX	218,00	1	1 rollo de 50 m.
10x0,7	280	560	X1007FX	307,80	1	1 rollo de 50 m.
12,7x0,4	210	420	X12704FX	282,20	1	1 rollo de 50 m.
12,7x0,4	355	710	X12707FX	346,30	1	1 rollo de 50 m.
16x0,4	260	520	X1604FX	307,80	1	1 rollo de 50 m.
16x0,7	445	890	X1607FX	371,90	1	1 rollo de 50 m.
20x0,4	305	610	X2004FX	352,80	1	1 rollo de 50 m.
20x0,7	535	1070	X2007FX	487,40	1	1 rollo de 45 m.

Hebilla flejinox HFX

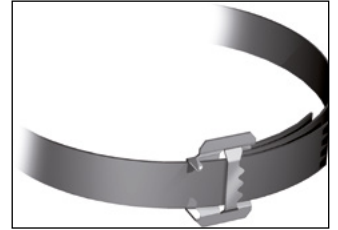

Características

- Acero Inoxidable A2 (AISI 304).
- Fleje laminado en frío para ofrecer una superficie muy pulida.
- Para cualquier tipo de poste exterior.

Cajas

HFX	Precios		Envase	Embalaje
	Código	Precio €/100 u.	(Uds)	(Uds)
Hebilla flejinox 10	9X10HFX	126,50	100	1800
Hebilla flejinox 12,7	9X127HFX	178,80	100	1800
Hebilla flejinox 16	9X16HFX	200,20	100	900
Hebilla flejinox 20	9X20HFX	243,80	100	900

Grapa flejinox GFX

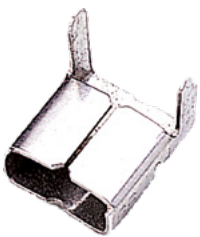

Características

- Acero Inoxidable A2 (AISI 304).
- Fleje laminado en frío para ofrecer una superficie muy pulida.
- Para cualquier tipo de poste exterior.

Cajas

GJX	Precios		Envase	Embalaje
	Código	Precio €/100 u.	(Uds)	(Uds)
Grapa flejinox 10	9X10GFX	59,00	100	1.800
Grapa flejinox 20	9X20GFX	126,80	100	900

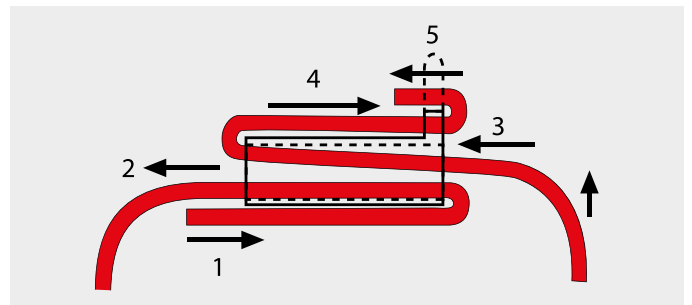

SUJECIÓN

Flejadora tornillo FTLL



Características

- Indicada para trabajar en cualquier posición (tensado manual).

Cajas

FTLL	Precios		Envase
	Código	Precio €/u.	 (Uds)
Flejadora suelta	9FTLL	405,90	1

Flejadora palanca FPAL



Características

- Indicada para trabajar desde el suelo o en plataforma estable.
- Maletín completo compuesto de: flejadora de palanca, pinza doblado, cizalla, martillo y 100 grapas Flejinox 20.

Cajas

FPAL	Precios		Envase
	Código	Precio €/u.	 (Uds)
Flejadora suelta	9FPAL	1405,80	1

Hebilla inox UAX



Características

- Acero Inoxidable A2 (AISI 304).
- Fleje laminado en frío para ofrecer una superficie muy pulida.
- Para cualquier tipo de poste exterior.

Cajas

UAX				Precios		Envase
	Grosor [mm]	Ancho [mm]	Carga máx. aplic. [mm]	Código	Precio €/100 u.	 (Uds)
TYS 5200 H	-	9,7	-	9XUAX*	252,60	50

* Hasta agotar existencias.

Cintapolo CA



* Con clavo XHA



Características

- Fabricado en acero dulce con acabado galvanizado sendzimir.
- Se puede instalar con clavadora gas.

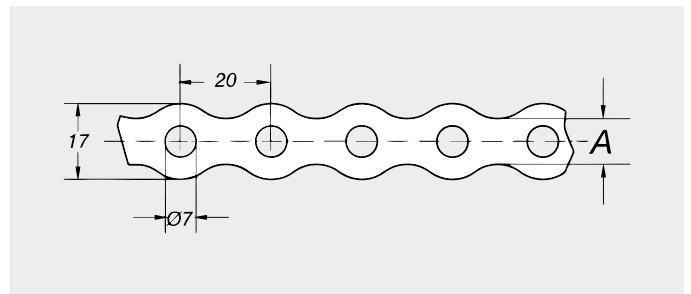

Cajas

CA			Precios		Envase
Espesor [mm]	A [mm]	Carga máx. aplic. [kg]	Código	Precio €/rollo	 (Uds)
0,7	10,4	95	CA	13,00	10 rollos de 10 m

Clip de viga alambre CAL

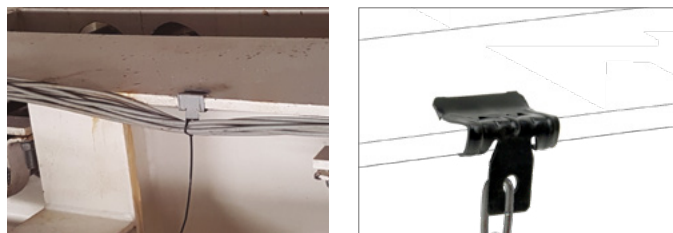

Características

- Sistemas de fijación rápida y sólida en viga metálica.
- No es necesario taladro ni soldadura.
- Apto para todo tipo de espesores de viga
- Orificio de fijación 6,3 mm para sujetar un alambre, gancho en S, perno/tuerca, etc.
- Acabado en gris (Láminas cinc aluminio) para exteriores, ambientes húmedos o ligeramente corrosivos y pintado negro para interiores.

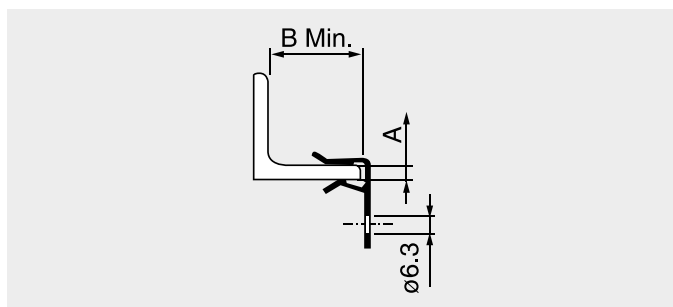

Cajas

CAL Gris		Precios		Envase	Embalaje
A [mm]	B [mm]	Código	Precio €/100 u.	(Uds)	(Uds)
1,5-4	18	915463CAL	59,80	100	1800
4-10	25	941063CAL	80,20	100	600
10-15	25	9101563CAL	89,10	100	600
15-20	25	9152063CAL	97,00	100	600

CAL Negro		Precios		Envase	Embalaje
A [mm]	B [mm]	Código	Precio €/100 u.	(Uds)	(Uds)
1,5-4	18	9415463CAL	44,00	100	1800
4-10	25	9441063CAL	61,80	100	600
10-15	25	94101563CAL	68,50	100	600
15-20	25	94152063CAL	74,40	100	600

Información Técnica

Espesor [mm]	Cargas [kN]
1,5-4	0,7
4-10	0,9
10-15	0,9
15-20	0,9

Clip de viga brida CBR

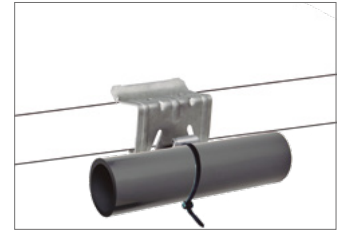

Características

- Sistemas de fijación rápida y sólida en viga metálica.
- No es necesario taladro ni soldadura.
- Apto para todo tipo de espesores de viga.
- Soporte para fijación de bridas de hasta 9 mm de ancho.
- Acabado en gris (Láminas cinc aluminio) para exteriores, ambientes húmedos o ligeramente corrosivos.

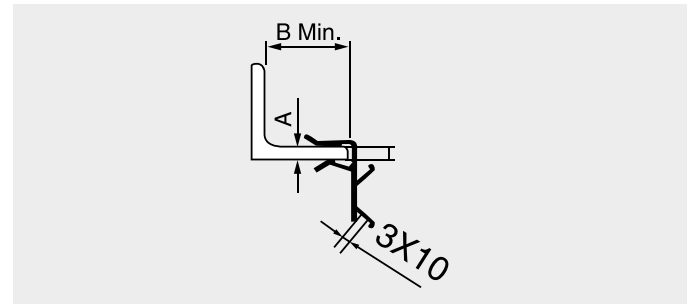

Cajas

CBR Gris		Precios		Envase	Embalaje
A [mm]	B [mm]	Código	Precio €/100 u.	(Uds)	(Uds)
1,5-4	18	9154CBR	94,50	100	900
4-10	25	9410CBR	118,50	100	600
10-15	25	91015CBR	122,40	100	600
15-20	25	91520CBR	142,60	50	450

Información Técnica

Esesor [mm]	Cargas [kN]
1,5-4	0,15
4-10	0,15
10-15	0,15
15-20	0,15

Clip de viga varilla CVA

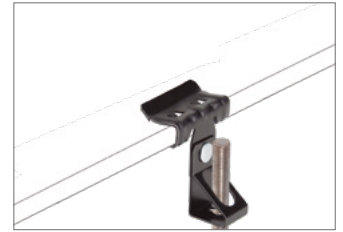

Características

- Sistemas de fijación rápida y sólida en viga metálica.
- No es necesario taladro, ni soldadura.
- Apto para todo tipo de espesores de viga.
- Soporte para varilla roscada M6 y M8.
- Acabado en gris (Láminas cinc aluminio) para exteriores, ambientes húmedos o ligeramente corrosivos y pintado negro para interiores.

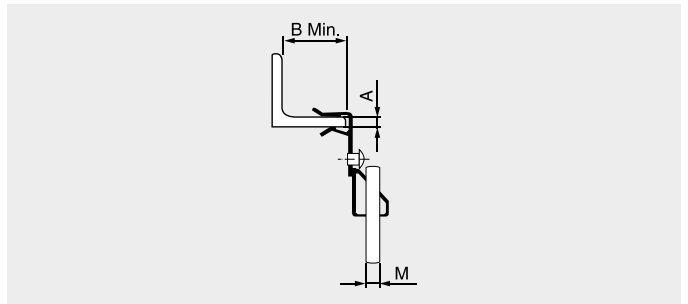

Cajas

CVA Gris M6		Precios		Envase	Embalaje
A [mm]	B [mm]	Código	Precio €/100 u.	(Uds)	(Uds)
1,5-4	18	91546CVA	156,20	50	450
4-10	25	94106CVA	193,70	50	300
10-15	25	910156CVA	202,50	50	300
15-20	25	915206CVA	235,30	50	300

CVA Gris M8		Precios		Envase	Embalaje
A [mm]	B [mm]	Código	Precio €/100 u.	(Uds)	(Uds)
1,5-4	18	91548CVA	156,20	50	450
4-10	25	94108CVA	193,70	50	450
10-15	25	910158CVA	202,50	50	300
15-20	25	915208CVA	235,40	50	300

CVA Negro M6		Precios		Envase	Embalaje
A [mm]	B [mm]	Código	Precio €/100 u.	(Uds)	(Uds)
1,5-4	18	941546CVA	120,20	50	450
4-10	25	944106CVA	148,80	50	300
10-15	25	9410156CVA	156,00	50	300
15-20	25	9415206CVA	181,10	50	300

CVA Negro M8		Precios		Envase	Embalaje
A [mm]	B [mm]	Código	Precio €/100 u.	(Uds)	(Uds)
1,5-4	18	941548CVA	120,20	50	450
4-10	25	944108CVA	148,80	50	450
10-15	25	9410158CVA	156,00	50	300
15-20	25	9415208CVA	181,10	50	300

Información Técnica

Espesor [mm]	Cargas [kN]
1,5-4	0,7
4-10	0,7
10-15	0,7
15-20	0,7

Clip de viga abrazadera CAB



Características

- Sistemas de fijación rápida y sólida en viga metálica.
- No es necesario taladro ni soldadura.
- Apto para todo tipo de espesores de viga
- Soporte con tornillo M6X9 mm para fijar abrazaderas y orificios M6 para varilla.
- Acabado en gris (Láminas cinc aluminio) para exteriores, ambientes húmedos o ligeramente corrosivos y pintado negro para interiores.

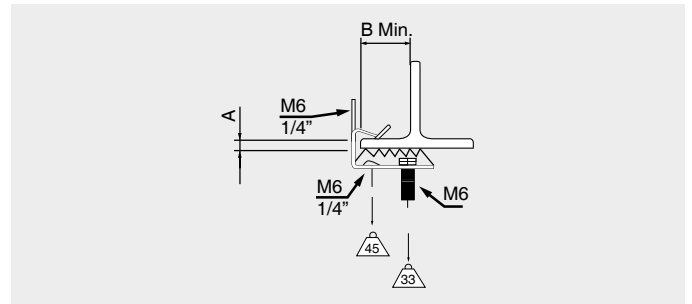

Cajas

CAB Gris M6x9		Precios		Envase	Embalaje
A [mm]	B [mm]	Código	Precio €/100 u.	(Uds)	(Uds)
3-7	35	9376CAB	179,10	50	450
7-13	35	97136CAB	196,10	50	300
14-20	35	914206CAB	215,60	50	300

CAB Negro M6x9		Precios		Envase	Embalaje
A [mm]	B [mm]	Código	Precio €/100 u.	(Uds)	(Uds)
3-7	35	94376CAB	137,80	50	450
7-13	35	94713CAB	150,80	50	300
14-20	35	941420CAB	174,20	50	300

Información Técnica	
Espesor [mm]	Cargas [kN]
3-7	0,33/0,45
7-13	0,33/0,45
14-20	0,33/0,45

SUJECIÓN

Clip de viga multifuncional CMV



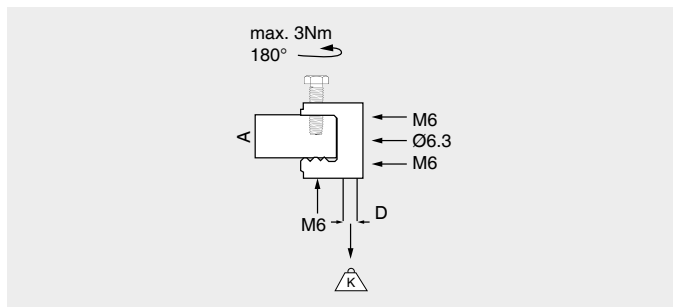
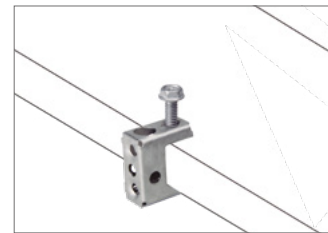

Características

- Sistemas de fijación rápida y sólida en viga metálica.
- No es necesario taladro ni soldadura.
- Apto para espesores de viga inferiores a 16 [mm]
- Agujeros M6 para fijación de abrazaderas y varilla.
- Acabado en gris (Láminas cinc aluminio) para exteriores, ambientes húmedos o ligeramente corrosivos.



Cajas

CMV Gris M6		Precios		Envase	Embalaje
A [mm]	B [mm]	Código	Precio €/100 u.	 (Uds)	 (Uds)
<16	10,7	96CMV	194,70	50	450

Información Técnica

Espesor [mm]	Cargas [kN]
<16	0,45

Clip de viga para cable CC

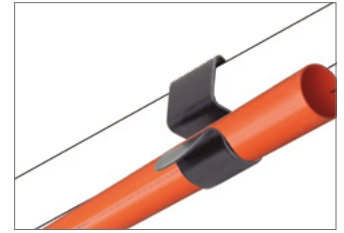
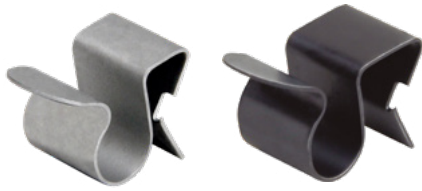

Características

- Sistemas de fijación rápida y sólida en viga metálica.
- No es necesario taladro ni soldadura.
- Apto para todo tipo de espesores de viga.
- Acabado en gris (Láminas cinc aluminio) para exteriores, ambientes húmedos o ligeramente corrosivos y pintado negro para interiores.

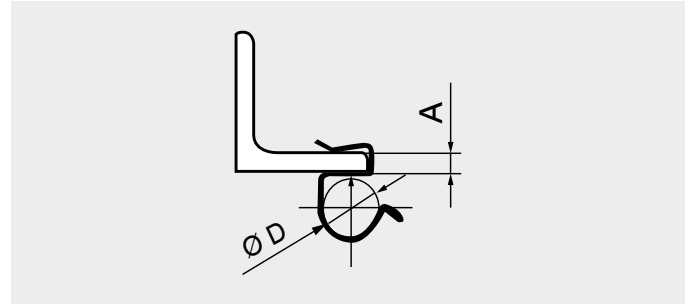

Cajas

CC Gris		Precios		Envase	Embalaje
A [mm]	Ø D [mm]	Código	Precio €/100 u.	(Uds)	(Uds)
1-4	6-7	947CC	20,50	100	1800
4-7,5	6-7	9757CC	19,30	100	1800
7,2-12	6-7	9127CC	19,30	100	1800
1-4	8-9	949CC	21,10	100	1800
4-7,5	8-9	9759CC	21,10	100	1800
7,2-12	8-9	9129CC	21,10	100	1800
1-4	10-11	9411CC	25,10	100	1800
4-7,5	10-11	97511CC	25,10	100	1800
7,2-12	10-11	91211CC	25,10	100	900
1-4	12-14	9414CC	30,10	100	1800
4-7,5	12-14	97514CC	30,10	100	1800
7,2-12	12-14	91214CC	30,10	100	900
1-4	15-18	9418CC	36,10	100	900
4-7,5	15-18	97518CC	36,10	100	900
7,2-12	15-18	91218CC	36,10	100	900
1-4	19-24	9424CC	41,50	100	900
4-7,5	19-24	97524CC	41,50	100	900
7,2-12	19-24	91224CC	41,50	100	900
1-4	25-30	9430CC	49,20	100	900
4-7,5	25-30	97530CC	49,20	100	900
7,2-12	25-30	91230CC	49,20	100	900

CC Negro		Precios		Envase	Embalaje
A [mm]	Ø D [mm]	Código	Precio €/100 u.	(Uds)	(Uds)
1-4	6-7	9447CC	15,20	100	1800
4-7,5	6-7	94757CC	15,20	100	1800
7,2-12	6-7	94127CC	15,20	100	1800
1-4	8-9	9449CC	16,40	100	1800
4-7,5	8-9	94759CC	16,40	100	1800
7,2-12	8-9	94129CC	16,40	100	1800
1-4	10-11	94411CC	19,00	100	1800
4-7,5	10-11	947511CC	19,00	100	1800
7,2-12	10-11	941211CC	19,00	100	900
1-4	12-14	94414CC	23,20	100	1800
4-7,5	12-14	947514CC	23,20	100	1800
7,2-12	12-14	941214CC	23,20	100	900
1-4	15-18	94418CC	27,80	100	900
4-7,5	15-18	947518CC	27,80	100	900
7,2-12	15-18	941218CC	27,80	100	900
1-4	19-24	94424CC	32,10	100	900
4-7,5	19-24	947524CC	32,10	100	900
7,2-12	19-24	941224CC	32,10	100	900
1-4	25-30	94430CC	37,50	100	900
4-7,5	25-30	947530CC	37,50	100	900
7,2-12	25-30	941230CC	37,50	100	900



Pinza a viga PMV

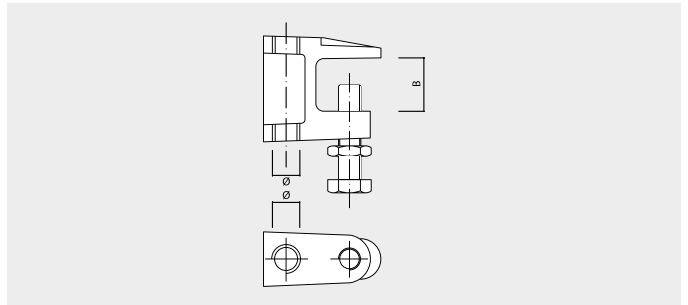

Características

- Para vigas de hasta 28 [mm]
- Material: pinza de hierro fundido, tornillo de acero templado y tuerca de acero.
- Tornillo DIN933 clase 8,8 según norma ISO 4753.
- Cincado.



PMV					Precios		Envase	Embalaje
Ø [mm]	B [mm]	Vds	FM	UL	Código	Precio €/100 u.	 (Uds)	 (Uds)
M8	18	x	-	x	98PMV	220,00	20	120
M10	20	x	x	x	910PMV	231,90	20	120
M12	26	x	x	x	912PMV	445,40	10	60

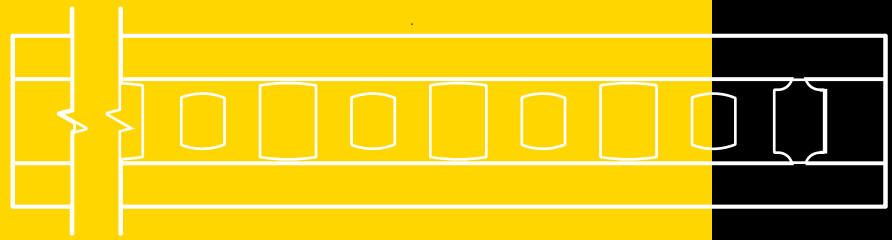

Perfiles y accesorios

Perfil y soporte Strut 41x21	188
Perfil y soporte Strut 41x41	189
Espárrago perfil deslizante Strut EPS	190
Tuerca rápida TSS	190
Tuerca perfil Strut TS	191
Soporte mural Strut SV	191
Soporte mural Strut SH	192
Placa bloqueo Strut PRS	192
Arandela para perfiles Strut AS	193
Refuerzo consola RC	193
Garra para viga Strut CRAP	194
Escuadra 90° para perfiles Strut ESC	194
Perfil y soporte 27x18	195
Perfil y soporte 28x30	196
Perfil 30x13	196
Perfil 35x13	197
Perfil 35x18	197
Perfil y soporte 38x40	198

Perfil 40x20	198
Perfil 2000 PG	199
Perfil 2000 PB	199
Perfil 1000 PVC	200
Perfil PO/TPO	200
Perfil multitub PTTR	201
Abrazadera multitub MT y MTTE	201
Espárrago perfil rápido EPR	202
Espárrago perfil EP	203
Tuerca perfil TS	203
Tornillo directo a perfil FTBT	204
Tornillo directo perfil TRBFT	204
Soporte mural SV	205
Soporte mural SH	205
Placa bloqueo PRS	206
Garra para viga CRAP	206
Soporte VT/HT	207
Tapón perfil TPP	207

Perfil y soporte **Strut 41x21**



Perfil Strut 41x21x2



Soporte Perfil Strut 41x21 SPE



Características

- Para instalaciones ligeras y medias.
- Perforación de 13,5 x 30 mm cada 50 [mm]
- Dentado de sierra que evita deslizamientos.

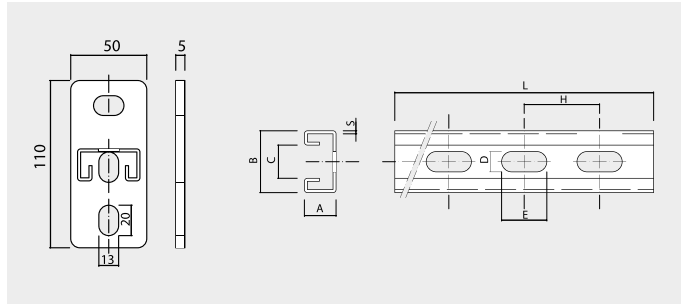

Perfil Strut 41x21x2 3 m. Galvanizado					Precios		Envase
L [mm]	BxAxS [mm]	C [mm]	DxE mm	H [mm]	Código	Precio €/u.	(Uds)
3000	41x21x2	22	13,5x30	50	41213000P20	43,30	1

Soporte perfil Strut 41x21 SPE Cincado					Precios		Envase
L [mm]	BxAxS [mm]	C [mm]	DxE mm	H [mm]	Código	Precio €/u.	(Uds)
150	41x21x2	22	10x20	50	4121150SPE	10,90	1
200	41x21x2	22	10x20	50	4121200SPE	12,30	1
300	41x21x2	22	10x20	50	4121300SPE	14,00	1
400	41x21x2	22	10x20	50	4121400SPE	15,80	1

Perfil y soporte Strut 41x41

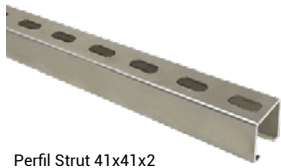

Perfil Strut 41x41x2





Soporte perfil Strut 41x41 SPE



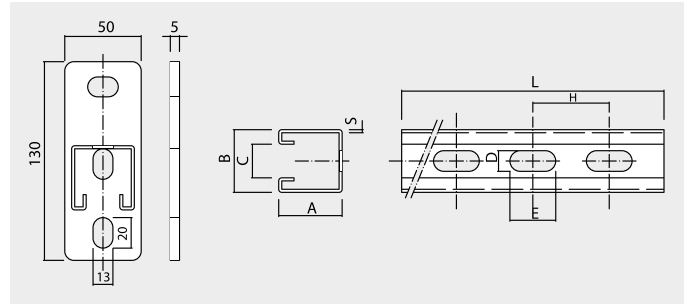

Características

- Para instalaciones medias.
- Perforación de 13,5 x 30 mm cada 50 [mm]
- Dentado de sierra que evita deslizamientos.



Perfil Strut 41x41x2 3 m. Galvanizado					Precios		Envase
L [mm]	BxAxS [mm]	C [mm]	DxE [mm]	H [mm]	Código	Precio €/u.	 (Uds)
3000	41x41x2	22	13,5x30	50	41413000P20	58,20	1

Soporte perfil Strut 41x41 SPE Cincado					Precios		Envase
L [mm]	BxAxS [mm]	C [mm]	DxE [mm]	H [mm]	Código	Precio €/u.	 (Uds)
200	41x41x2	22	10x20	50	4141200SPE	10,90	1
300	41x41x2	22	10x20	50	4141300SPE	15,50	1
450	41x41x2	22	10x20	50	4141450SPE	21,60	1
600	41x41x2	22	10x20	50	4141600SPE	24,00	1
750	41x41x2	22	10x20	50	4141750SPE	27,00	1
1000	41x41x2	22	10x20	50	41411000SPE	34,70	1

Soporte perfil Strut 41x41 SPE Galvanizado en caliente					Precios		Envase
L [mm]	BxAxS [mm]	C [mm]	DxE [mm]	H [mm]	Código	Precio €/u.	 (Uds)
600	41x41x2	22	10x20	50	HD4141600SPE	29,00	1
750	41x41x2	22	10x20	50	HD4141750SPE	30,60	1
1000	41x41x2	22	10x20	50	HD41411000SPE	39,40	1

SUJECIÓN

Espárrago perfil deslizante Strut EPS



Características

- Fácil colocación.
- Premontado para la instalación de abrazaderas u otros accesorios sobre perfil Strut.
- Se adapta a todas las medidas de perfiles y soportes.
- Cincado.

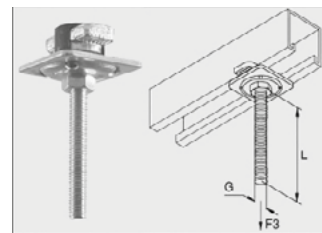

Instalación

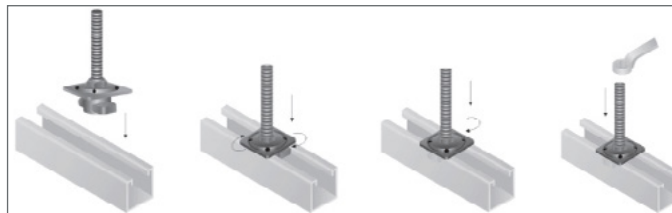

Paso 1

Paso 2

Paso 3

Paso 4

Espárrago perfil deslizante Strut EPS

Espárrago perfil deslizante Strut EPS				Precios		Envase
Ø [mm]	L [mm]	S [mm]	SW [mm]	Código	Precio €/100 u.	 (Uds)
M8	50	6	13	9418EPS	136,40	100
M10	50	6	17	94110EPS	150,00	50
M12	50	6	19	94112EPS	163,50	50

Tuerca rápida TSS



Características

- Fácil y rápido.
- Sistema de prefijación, incluso con el perfil en vertical para ajustar la instalación.
- Se adapta a todas las medidas de perfiles.
- Tuerca dentada para un fijación óptima.
- Cincado.



Instalación



Tuerca rápida TSS

Tuerca rápida TSS		Precios		Envase	Embalaje
Ø [mm]	Código	Precio €/100 u.	 (Uds)	 (Uds)	
M8	9418TSS	97,20	100	900	
M10	94110TSS	111,10	100	400	
M12	94112TSS	125,00	50	450	

Tuerca perfil Strut TS

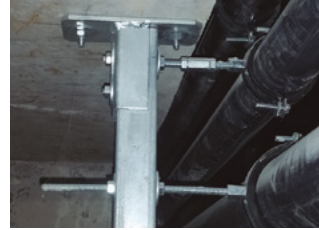

Características

- Con ranura dentadas para una mejor fijación en la pared interior del perfil.
- Tuerca válida para todas las medidas de perfiles
- Cincado.

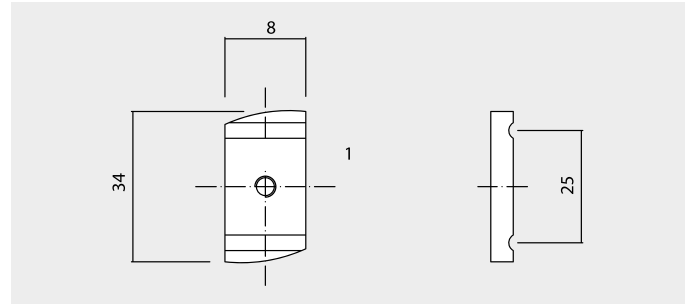

Tuerca perfil Strut TS		Precios		Envase	Embalaje
Ø [mm]	Para perfiles	Código	Precio €/100 u.	(Uds)	(Uds)
M6	41x41 / 41x21	9416TS	87,20	50	600
M8	41x41 / 41x21	9418TS	92,60	50	600

Soporte mural Strut SV



Características

- Pletina con perfil soldado y espárrago perfil pre-montado.
- Taladros colisos perpendiculares para facilitar el ensamblaje.
- Cincado.

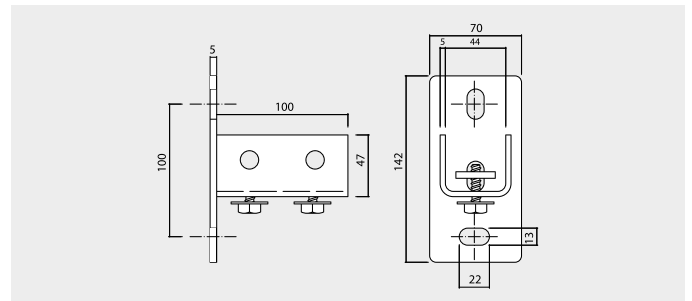

Soporte mural Strut SV Vertical			Precios		Envase
Ø [mm]	H [mm]	Para perfiles	Código	Precio €/u.	(Uds)
M10	47	41x41 / 41x21 / 40x60 / 38x40	941SV	18,20	10

Soporte mural Strut SH



Características

- Pletina con perfil soldado y espárrago perfil premontado.
- Taladros colisos perpendiculares para facilitar el ensamblaje.
- Cincado.

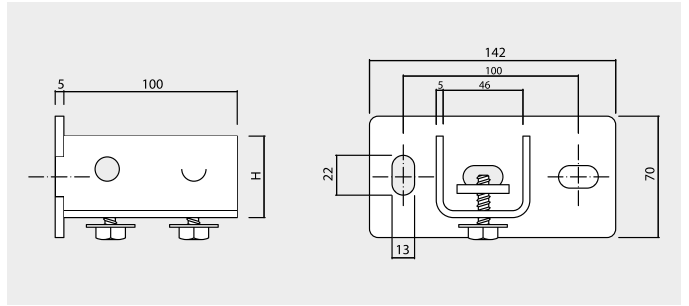

Soporte mural Strut SH Horizontal			Precios		Envase
Ø [mm]	H [mm]	Para perfiles	Código	Precio €/u.	 (Uds)
M10	47	41x41 / 41x21 / 40x60 / 38x40	941SH	18,20	10

Placa bloqueo Strut PRS



Características

- Acero cincado.
- Placa de bloqueo M8.

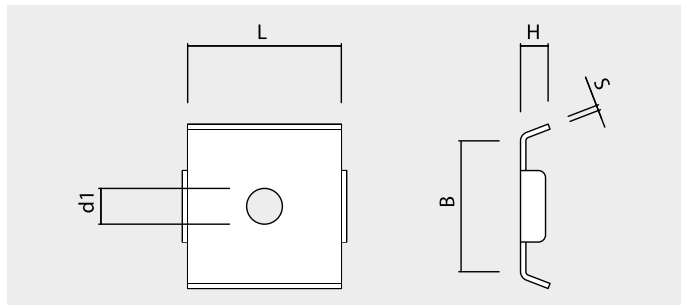

Placa bloqueo Strut PRS						Precios		Envase
H [mm]	B [mm]	S [mm]	L [mm]	d1 [mm]	Para perfiles	Código	Precio €/100 u.	 (Uds)
8	42	2	40	9	41x41/41x21	941PRS	136,10	100

Arandela para perfiles Strut AS



Características

- Arandelas planas para perfiles.
- Cincado.

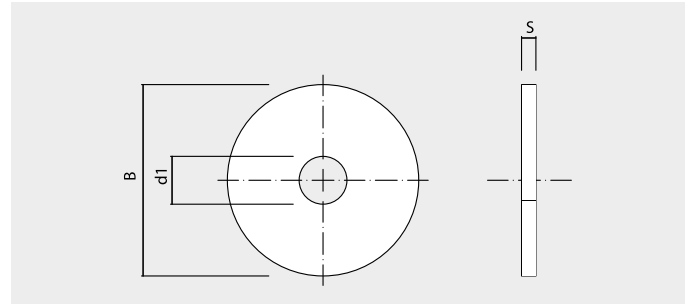

AS				Precios		Envase
Ø [mm]	B [mm]	d ₁ [mm]	S [mm]	Código	Precio €/100 u.	Envase (Uds)
M8	40	8,5	3	98AS	29,30	100
M10	40	10,5	3	910AS	27,80	100

Refuerzo consola RC



Características

- Multiplica por 2,5 la carga máx. recomendada.
- Adaptable a todos los soportes STRUT.
- Cincado.

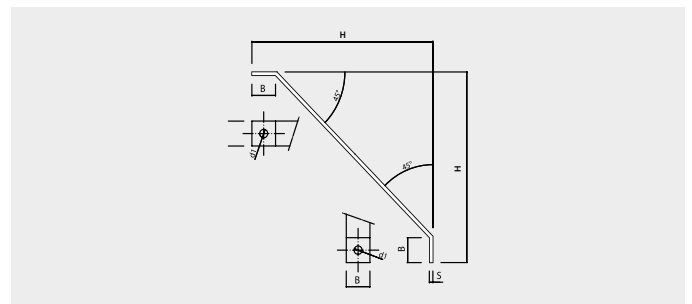

Refuerzo consola RC				Precios		Envase
H [mm]	B [mm]	S [mm]	d1 [mm]	Código	Precio €/100 u.	Envase (Uds)
260	40	5	15	9300RC	1023,20	5

Garra para viga Strut CRAP



Características

- Para perfil 41x41 y 41x21.
- 6 mm de espesor.
- Tuercas y arandelas incluidas.
- Carga máx. recomendada 4500 N.
- Cincado.

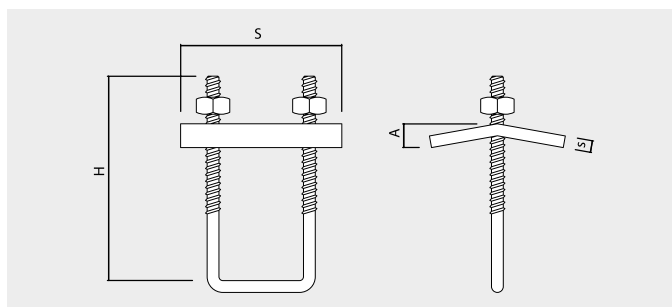

Garra para viga Strut CRAP					Precios		Envase
Ø [mm]	L [mm]	H [mm]	S [mm]	Para perfil	Código	Precio €/100 u.	(Uds)
M8	105	86	6	41x41/41x21	941CRAP	314,40	25

Escuadra 90° para perfiles Strut ESC



Perfil Strut 41x21x2

Perfil Strut 41x21x2

Perfil Strut 41x21x2

Perfil Strut 41x21x2



Características

- Sistema universal de ensamblaje en perfiles.
- Cincado.

Escuadra 90° para perfiles Strut ESC				Precios		Envase
	Agujeros	Ángulo	Dimensiones	Código	Precio €/100 u.	(Uds)
Escuadra 90° / 2	2	90°	50x40x5	9412ESC	154,70	25
Escuadra 90° / 3	3	90°	105x40x5	9413ESC	235,20	20
Escuadra 90° / 4	4,00	90°	105x40x5	9414ESC	265,20	20
Escuadra 90° / REFOR	4,00	90°	-	9414ESCR	692,30	25

Perfil y soporte 27x18



Perfil 27x18

Soporte perfil 27x18 SPE

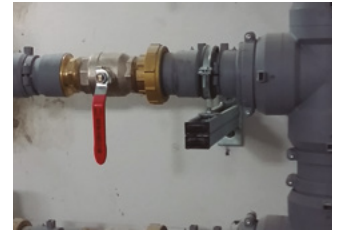

Características

- Fijación de abrazaderas con espárrago perfil EPR.
- Para fijación mural horizontal de tubos y bandejas.
- Soporte con pletina de 110x40x4,5 mm con agujero coliso horizontal y vertical de 13x21 [mm]

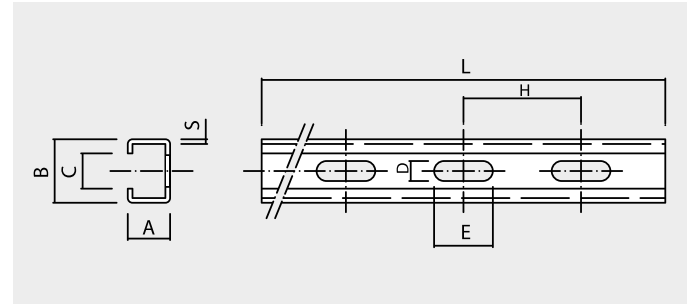

Perfil 27x18 Galvanizado						Precios		Envase
L [mm]	BxAxS [mm]	C [mm]	D1xE [mm]	D [mm]	H [mm]	Código	Precio €/u.	(Uds)
2000	27x18x1,2	15	8x20	10	50	2718PSTD	17,30	10

Soporte perfil 27x18 SPE Cincado					Precios		Envase
L [mm]	BxAxS [mm]	C [mm]	DxE [mm]	H [mm]	Código	Precio €/u.	(Uds)
200	27x18x1,2	15	8x24	50	92718200SPE	7,00	20
300	27x18x1,2	15	8x24	50	92718300SPE	7,40	20

SUJECIÓN

Perfil y soporte 28x30



Perfil 28x30



Soporte perfil 28x30 SPE



Características

- Fijación de abrazaderas con espárrago perfil EPR.
- Para fijación mural horizontal de tubos y bandejas.
- Soporte con pletina de 110x40x4,5 mm con agujero.

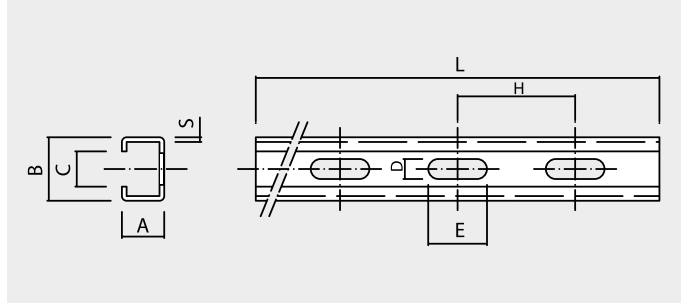

Perfil 28x30 Galvanizado						Precios		Envase
L [mm]	BxAxS [mm]	C [mm]	D ₁ xE [mm]	O [mm]	H [mm]	Código	Precio €/u.	Uds
2000	28x30x2	14	10,2x20	10	50	2830PSTD	32,10	6
3000	28x30x2	14	10,2x20	10	50	28303000PSTD	48,70	1

Soporte perfil 28x30 SPE Cincado					Precios		Envase
L [mm]	BxAxS [mm]	C [mm]	DxE [mm]	H [mm]	Código	Precio €/u.	Uds
400	28x30x1,5	15	8,5x25	50	2830400SPE	9,80	1

Perfil 30x13



Características

- Fijación de abrazaderas con espárrago perfil EPR.

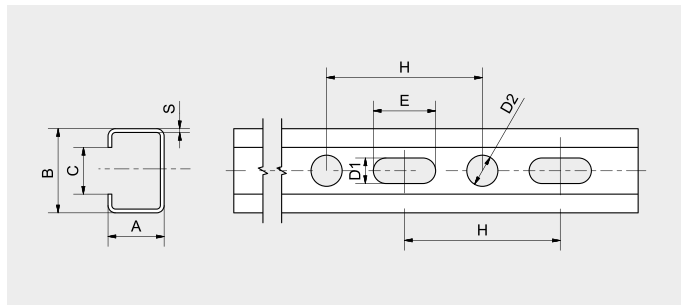

Perfil 30x13 Galvanizado						Precios		Envase
L [mm]	BxAxS [mm]	C [mm]	D ₁ xE [mm]	D ₂ [mm]	H [mm]	Código	Precio €/u.	Uds
2000	30x13x1,2	15	8x20	10	50	3013PSTD	17,70	12

Perfil 35x13



Características

- Fijación de abrazaderas con espárrago perfil EPR.

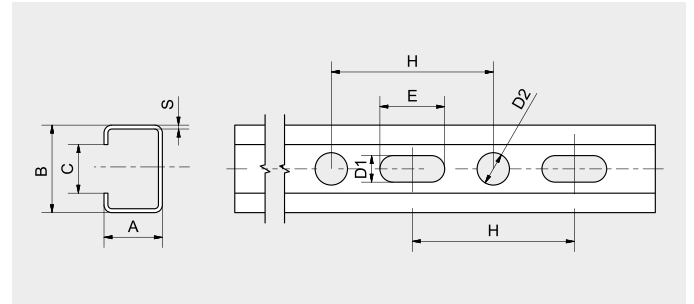

Perfil 35x13 Galvanizado						Precios		Envase
L [mm]	BxAxS [mm]	C [mm]	D1xE [mm]	D2 [mm]	H [mm]	Código	Precio €/u.	Envase (Uds)
2000	35x13x1,2	15,5	8x20	10	50	3513PSTD	19,60	12

Perfil 35x18



Características

- Fijación de abrazaderas con espárrago perfil EPR.
- Ideal para montaje de abrazadera MULTITUB.

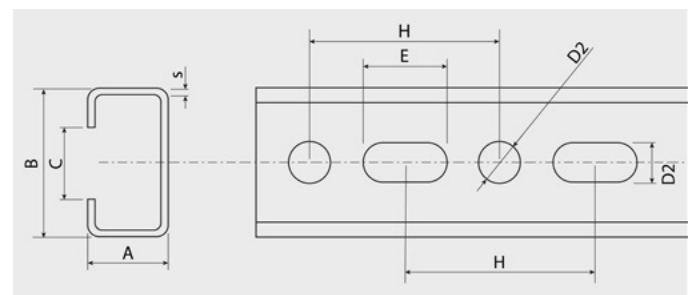

Perfil T2000P Galvanizado						Precios		Envase
L [mm]	BxAxS [mm]	C [mm]	D1xE [mm]	D2 [mm]	H [mm]	Código	Precio €/u.	Envase (Uds)
2000	35x18x1,5	16,5	10x20	10	18	T2000P	27,00	10

Perfil y soporte 38x40



Perfil 38X40

Soporte perfil 38x40 SPE



Características

- Fijación de abrazaderas con espárrago perfil EPR.
- Disponible en largos de 2 y 3 m.
- Para fijación mural horizontal de tubos y bandejas.
- Soporte con pletina de 130x50x5 mm con agujero.
- Coliso horizontal y vertical de 12x20 [mm]
- Admite MT.

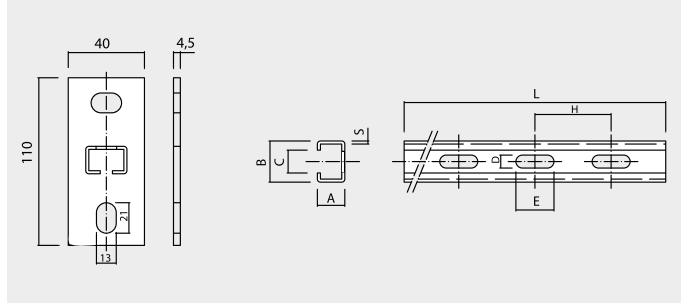

Perfil 38X40 Galvanizado						Precios		Envase
L [mm]	BxAxS [mm]	C [mm]	D1xE [mm]	O [mm]	H [mm]	Código	Precio €/u.	Uds
2000	38x40/2000	38x40x2	12x20	10	50	3840PSTD	50,30	6
3000	38x40/3000	38x40x2	12x20	10	50	38403000PSTD	76,20	6

Soporte perfil 38x40 SPE Cincado					Precios		Envase
L [mm]	BxAxS [mm]	C [mm]	DxE [mm]	H [mm]	Código	Precio €/u.	Uds
200	38x40x2	17	12x20	50	93840200SPE	10,00	10
300	38x40x2	17	12x20	50	93840300SPE	12,10	10
400	38x40x2	17	12x20	50	3840400SPE	14,90	6
500	38x40x2	17	12x20	50	3840500SPE	17,60	6
600	38x40x2	17	12x20	50	3840600SPE	20,20	6
800	38x40x2	17	12x20	50	3840800SPE	21,60	1

Perfil 40x20

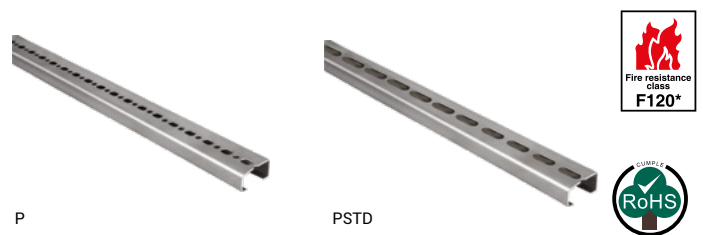

P

PSTD



Características

- Perfil P. Fijación directa con tornillo FT, BT y TRBFT.
- Perfil PSTD 10x20 troquel estándar.
- Versátil, permite instalación en ambos lados.

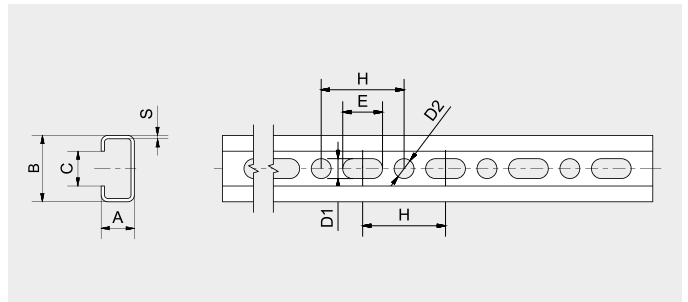

Perfil 40x20 Galvanizado						Precios		Envase
L [mm]	BxAxS [mm]	C [mm]	D1xE [mm]	D2 [mm]	H [mm]	Código	Precio €/u.	Uds
2000	40x20x1,5	24,5	8x12	6	25	4020P	27,90	10
2000	40x20x1,5	24,5	10x30	-	50	4020PSTD	27,90	10

Perfil 2000 PG

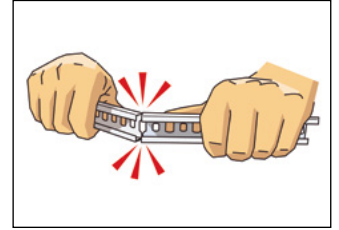

Características

- Precorte cada 100 [mm] que permite sección manual.
- Multitud de instalaciones:
 - Abrazaderas de plástico AN, ABM, ABT, MC
 - Bridas de nylon
 - Conductos
- Posibilidad de fijación con pistolas de gas.

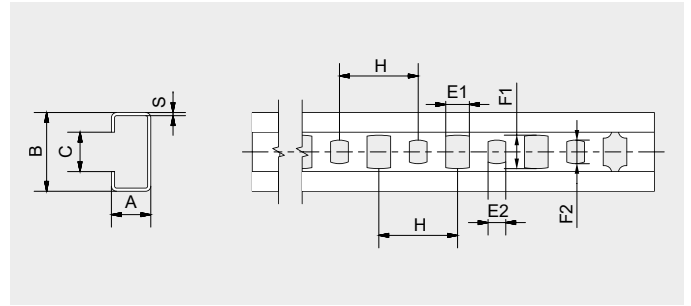

Perfil 2000PG Galvanizado

						Precios		Envase
L [mm]	BxAxS [mm]	C [mm]	E1xF1 [mm]	E2xF2 [mm]	H [mm]	Código	Precio €/u.	Uds
2000	20x10x0,8	10	6x8,5	4,5x6	20	2000PG	9,20	20

* Para la venta individual (etiqueta y código de barra por perfil)

Perfil 2000 PB



Características

- Fijación directa con tornillo FT.
- Versátil, permite instalación en ambos lados.
- Acero galvanizado sendzimir.
- Multitud de instalaciones:
 - Abrazaderas de plástico.
 - Bridas
 - Conducto

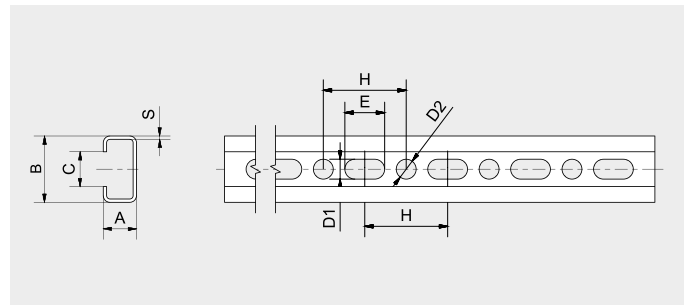

Perfil 2000PB Galvanizado

						Precios		Envase
L [mm]	BxAxS [mm]	C [mm]	D1xE [mm]	D2 [mm]	H [mm]	Código	Precio €/u.	Uds
2000	20x10x1	10,5	6x12	6	25	2000PB	11,90	20

* Para la venta individual (etiqueta y código de barra por perfil)

Perfil 1000 PVC

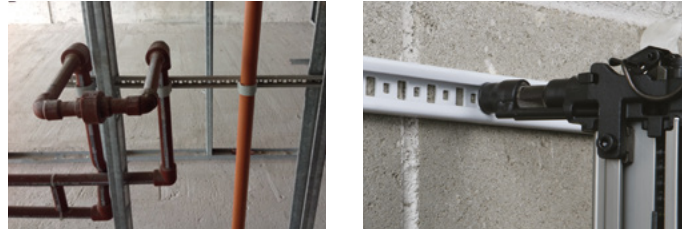

Características

- Rápido y cómodo: no requiere herramientas para el corte.
- Precorte cada 100 [mm]
- Para sujeción de abrazaderas en serie AN, ABM, ABT, MC, SC y SCD.
- Posibilidad de fijación con clavadora a gas.
- El troquelado en la base permite fijar bridas hasta 9 mm de ancho.
- PVC.

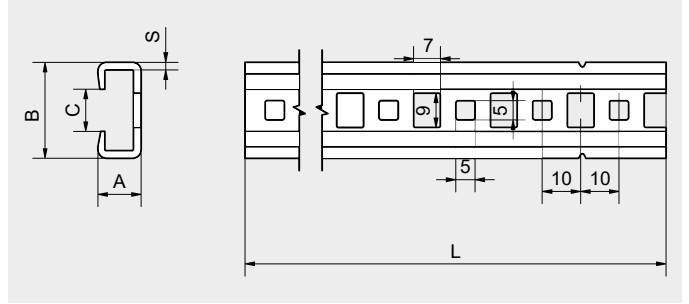

Perfil 1000 PVC			Precios		Envase
L [mm]	BxAxS [mm]	C [mm]	Código	Precio €/u.	Envase (Uds)
1.000	25 x 11,5 x 2	11	P1000PVC	4,70	30

Perfil PO / TPO

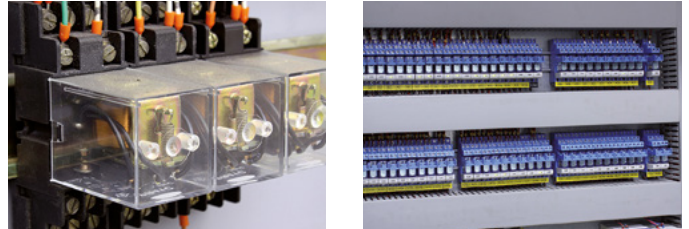

Características

- Sin Cr VI, cumple normativa ROHS. Agujeros colisos. Para la fijación de automatismos. Según norma EN 60715.

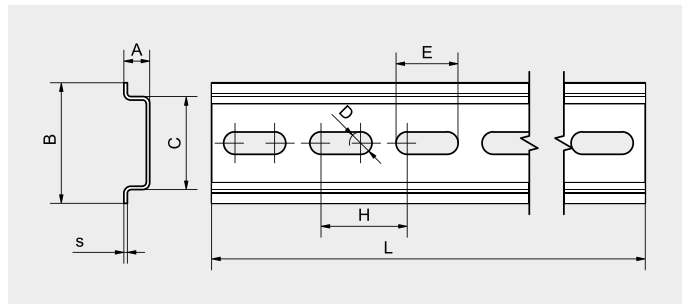

Perfil PO / TPO Galvanizado					Precios		Envase
L [mm]	BxAxS [mm]	C [mm]	D1xE [mm]	H [mm]	Código	Precio €/u.	Envase (Uds)
2000	35x7,5x1	27	6,5x18	25	3575TPO	10,90	20
2000	35x7,5x1	27	-	-	3575PO	10,50	20
2000	35x15x1	27	6,5x18	25	3515TPO	14,30	10
2000	35x15x1	27	-	-	3515PO	14,10	10

Perfil multitub PTTR



Características

- Disponible en diferentes medidas para una correcta aplicación.
- Ideal para la fijación de cables en túneles combinación con abrazaderas MULTITUB.
- Dispone de un troquelado lateral con cantos redondeados y coliso $\varnothing 12 \times 20$ para facilitar el montaje con BAP.
- Consultar otros acabados.
- Instalaciones en túneles con limitación de espacio.

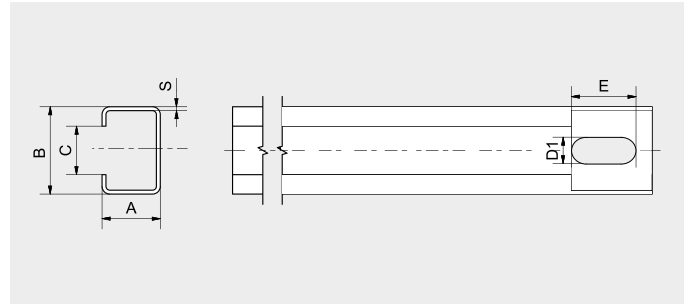

Perfil multitub PTTR Galvanizado

Perfil multitub PTTR Galvanizado				Precios		Envase
L [mm]	BxAxS [mm]	C [mm]	D1xE [mm]	Código	Precio €/u.	 (Uds)
250	35 x 18 x 1.5	16,5	12x20	250PTTR	4,30	20
400	35 x 18 x 1.5	16,5	12x20	400PTTR	6,10	20
500	35 x 18 x 1.5	16,5	12x20	500PTTR	7,70	20
600	35 x 18 x 1.5	16,5	12x20	600PTTR	10,10	20
800	35 x 18 x 1.5	16,5	12x20	800PTTR	11,10	10
1000	35 x 18 x 1.5	16,5	12x20	1000PTTR	13,30	10

Abrazadera multitub MT y MTTE





MTTE



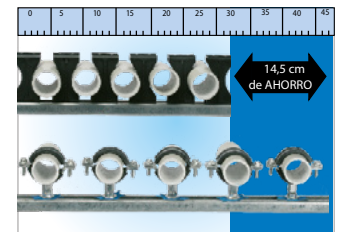

MT



Cajas

MT					Precios		Envase	Embalaje
\varnothing [mm]	L [mm]	H [mm]	B [mm]	d_s [mm]	Código	Precio €/100 u.	 (Uds)	 (Uds) Tornillo
8-36	23	36	26	M8	94836MT	132,90	100	600 DIN84
14-48	26	45	26	M8	941448MT	157,60	100	- DIN84
24-72	38	70	38	M8	942472MT	217,20	100	- DIN84
60-90	70	100	34	M8	946090MT	493,90	50	- DIN912

MTTE					Precios		Envase	Embalaje
\varnothing [mm]	L [mm]	H [mm]	B [mm]	d_s [mm]	Código	Precio €/100 u.	 (Uds)	 (Uds)
8-36	16,5	34	18	M4	94836MTTE	109,30	100	900

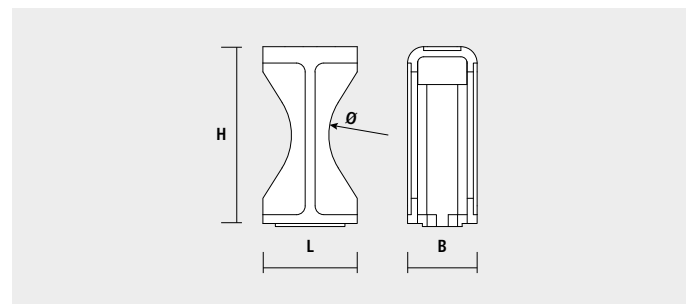

Espárrago perfil rápido EPR

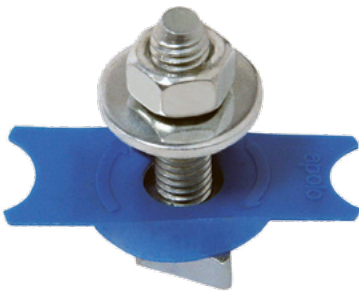

Características

- Polivalente: para cualquier tipo de perfil metálico de regata de 12 hasta 18 [mm]
- Rápido, en dos pasos: introducir y girar.
- Cómodo: las dos alas laterales permiten sujetar de forma más fácil.
- Se agarra al perfil con un giro de 90°.
- Permite fijar directamente varilla. Al ser desmontable puede fijar la base y unir directamente la varilla.
- M6x35/121 y M8x35/121 - compatibles con perfil 27x18, 28x30, 30x13 y 35x13.
- M6x35/162 y M8x35/162 - compatibles con T2000P y 38x40.

Instalación

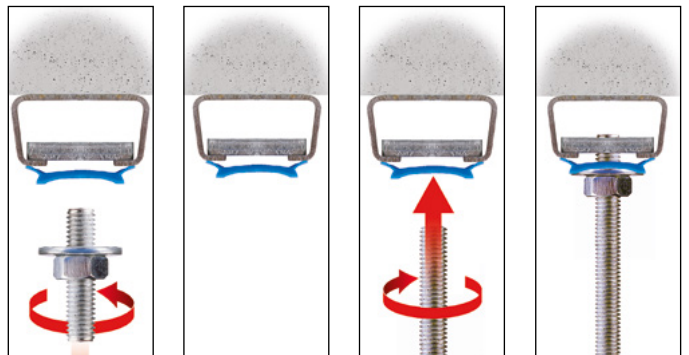

Extraer el espárrago previamente fijado.

El soporte permanece fijado al perfil.

Introducir otro elemento de fijación.

Bajar varilla

Espárrago perfil EPR	Precios		Envase	Embalaje
	Código	Precio €/100 u.	 (Uds)	 (Uds)
M6x35/12	963512EPR	111,10	100	900
M6x35/16	963516EPR	123,20	100	900
M8x35/12	983512EPR	129,20	50	450
M8x35/16	983516EPR	143,00	50	450

Espárrago perfil EP



Características

- Espárrago remachado en la tuerca.
- Arandela de \varnothing 35 [mm]
- Premontado, permite una fijación rápida de abrazaderas y perfiles.
- Cincado.

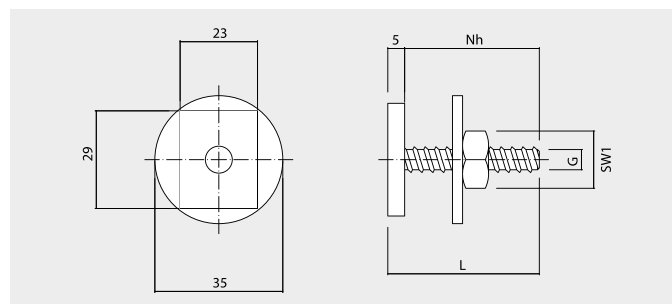

Espárrago perfil EP

Espárrago perfil EP				Precios		Envase	Embalaje
\varnothing [mm]	L [mm]	Nh [mm]	Para perfil	Código	Precio €/100 u.	(Uds)	(Uds)
M6	-	25	2000PG, 2000PB, 1000PVC	9625EP	92,90	100	1200
M8	40	35	38x40	9840EP	99,40	100	-
M10	55	40	38x40	91040EP	107,00	100	-
M10	-	25	38x40, T2000P	91025EP	205,40	25	450

* Hasta agotar existencias.

Tuerca perfil TS

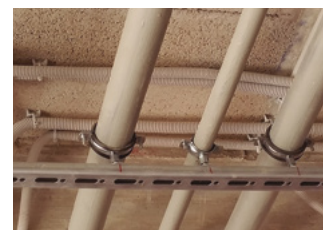

Características

- Cincado.
- Grosor 5 mm.

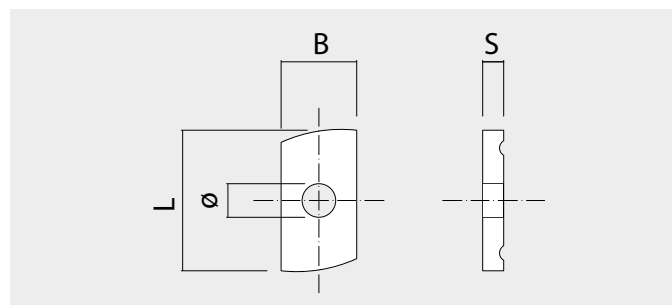

Tuerca perfil TS

Tuerca perfil TS					Precios		Envase	Embalaje
\varnothing [mm]	L [mm]	B [mm]	S [mm]	Para perfil	Código	Precio €/100 u.	(Uds)	(Uds)
M8	34	18	5	38x40	9388TS	51,90	100	1200
M10	34	18	5	38x40	93810TS	51,90	100	1200

Tornillo directo a perfil FTBT



Características

- El sistema de fijación más rápido de bandejas sobre perfiles y soportes metálicos.
- Punta Torx 30 incluida en cada caja.
- Tornillo con rosca FT que evita el aflojamiento del tornillo pues trabaja como macho de roscar. Las tuercas no son necesarias.
- Cabeza de \varnothing 13.5 [mm]
- Instalable en toda la nueva gama de perfiles.

Tornillo directo a perfil FTBT		Precios		Envase	Embalaje
	Dimensiones $d_s \times L_s$	Código	Precio €/ 100.	(Uds)	(Uds)
Fastite M7x20 Torx 30	M7x20	9720FTBT	39,30	100	1800

Información Técnica

Grosor de chapa* [mm]	Resistencia recomendada [kg]
1	50
1.5	90
2	130

Tornillo directo perfil TRBFT



Características

- El sistema de fijación más rápido en perfiles metálicos .
- No se afloja. Evita el uso de tuercas y arandelas.
- Extruye el material para conseguir una mayor resistencia.
- Versátil. Dos tipos de rosca métricas.
- Tornillo doble rosca: FT M7x12 y métrica, M8x15 o M6x6.
- Cincado.
- Instalación con la Llave Torab ST M8.
- Montaje de abrazaderas M6 y M8 en perfiles.

Instalación

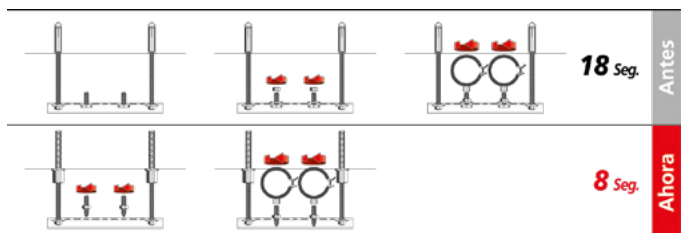

Tornillo directo perfil TRBFT		Precios		Envase	Embalaje
Dimensiones [mm]	Código	Precio €/ 100 u.	(Uds)	(Uds)	
7x12	966TRBFT	55,50	100	1800	
7x12	9815TRBFT	97,20	100	1800	
4x9	966TRBFTPG	35,00	100	1800	

Soporte mural SV



Características

- Cincado.
- Sin tornillos.

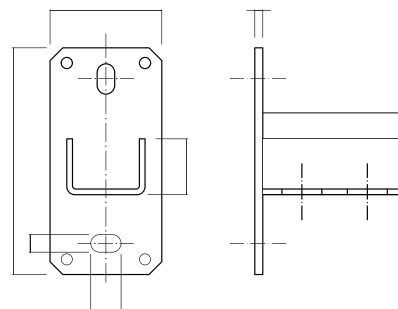

Soporte mural SV	Precios		Envase
Perfil [mm]	Código	Precio €/u.	 (Uds)
27x18 / 28x30 / 30x13	927SV	8,40	10
38x40 / 40x60	938SV	12,90	10

Soporte mural SH

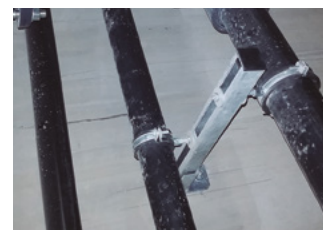

Características

- Cincado.
- Sin tornillos.

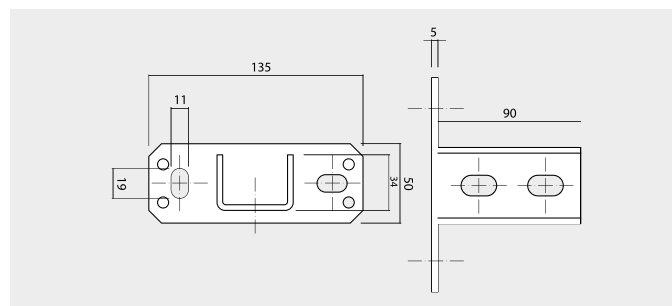

Soporte mural SH	Precios		Envase
Perfil [mm]	Código	Precio €/u.	 (Uds)
27x18 / 28x30 / 30x13	927SH	9,00	10
38x40 / 40x60	938SH	15,40	10

Placa bloqueo PRS



Características

- Acero cincado.
- Placa de bloqueo M8.

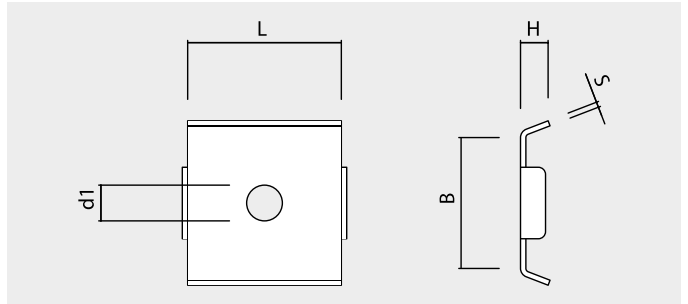

Placa bloqueo PRS							Precios		Envase	Embalaje
Ø [mm]	D ₁ [mm]	D [mm]	S [mm]	L [mm]	K [mm]	Para perfil	Código	Precio €/100 u.	(Uds)	(Uds)
M8	11	30,50	3	24	11	38x40	938PRS	92,60	50	600

Garra para viga CRAP



Características

- Para instalaciones bajo viga sin agujerear ni soldar.
- Cincado.

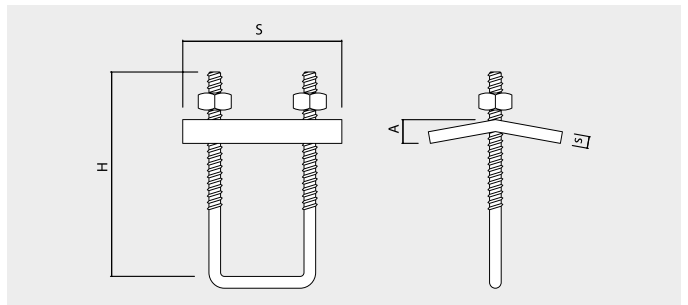

Garra para viga CRAP						Precios		Envase
Ø [mm]	S [mm]	H [mm]	s [mm]	A [mm]	Para perfil	Código	Precio €/100 u.	(Uds)
M8	80	100	4	< 20	38x40	938CRAP	594,60	20

Soporte VT / HT



Características

- Para la fijación de perfiles 27/18 y 28/30.
- Soldadura continua.
- Tornillería incluida.
- Cincado.

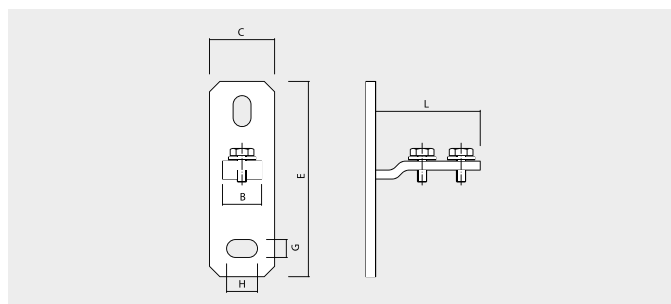

Soporte VT / HT

Soporte VT / HT						Precios		Envase
Ø [mm]	C [mm]	E [mm]	Gxh [mm]	L [mm]	Para perfil	Código	Precio €/u.	 (Uds)
M10	45	120	10x20	55	27/18 y 28/30	9VTE	297,60	25
M10	45	120	10x20	55	27/18 y 28/30	9HTE	324,10	25



Tapón perfil TPP



Características

- Canto redondeado.
- Protege de la corrosión a los extremos del perfil.

Tapón perfil TPP

Tapón perfil TPP		Precios		Envase	Embalaje
Para perfiles	Color	Código	Precio €/ 100 u.	 (Uds)	 (Uds)
40 x 20	Negro	944020TPP	65,10	100	900
27 x 18	Negro	942718TPP	46,10	100	900
28 x 30	Negro	942830TPP	69,10	100	900
38 x 40	Negro	943840TPP	85,90	100	450

**Infórmate de nuestras
estructuras y fijaciones solares
para viviendas**

www.celofixings.es

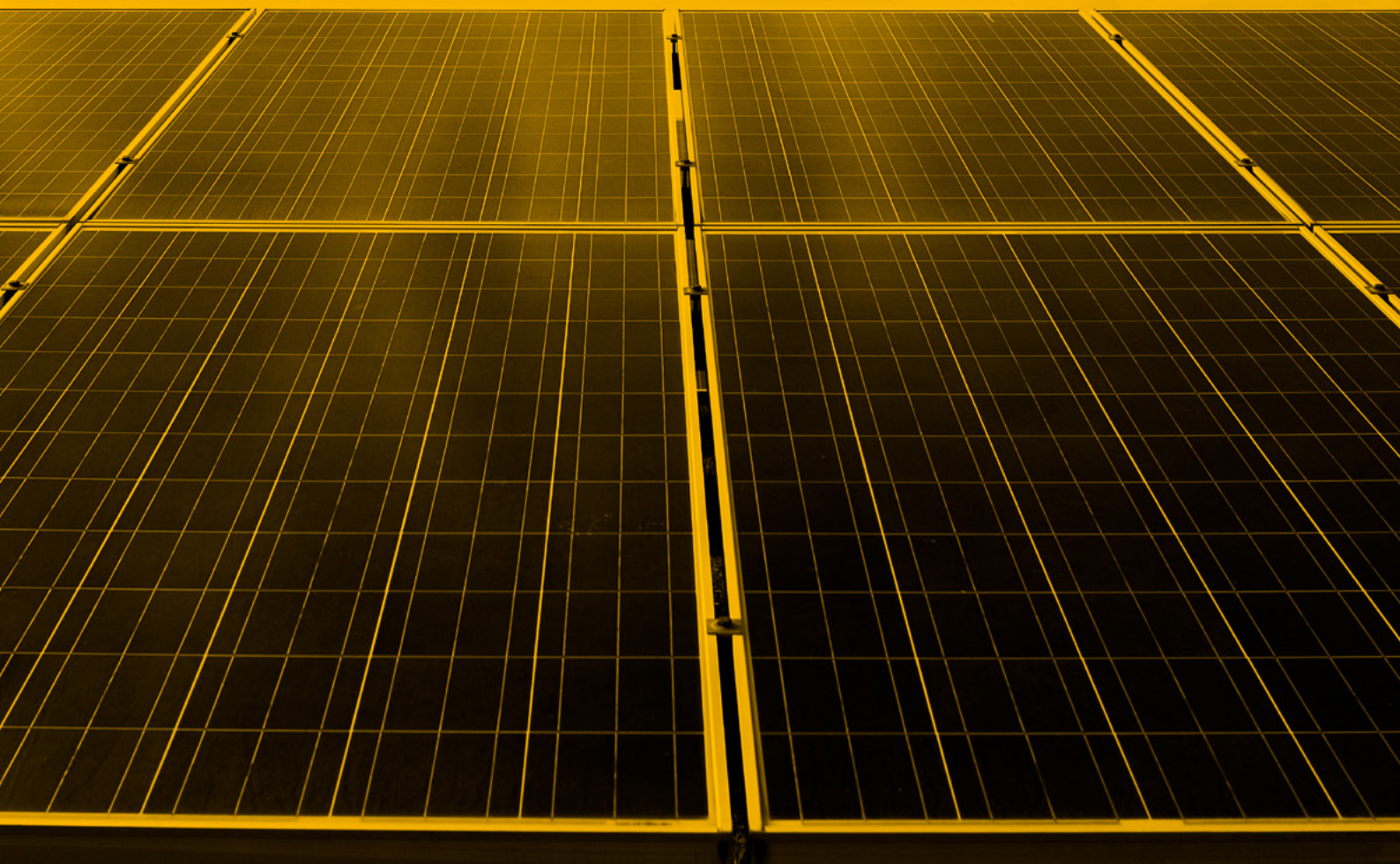

Clavadora a gas y accesorios

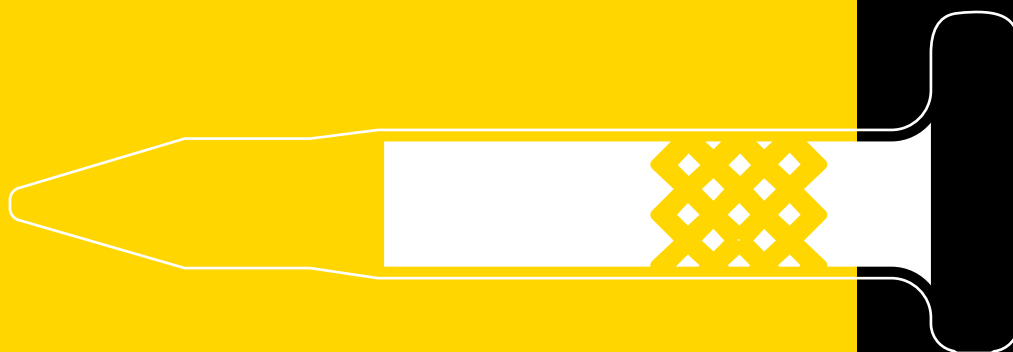

Clavadora a gas FORCE ONE	210	Grapa de plástico FPD	219
Clavos de acero XHA	211	Gapa de plástico FP	220
Bombona gas GASFONE	211	Abrazadera metálica para mazos de cables CHS	221
Abrazadera Abranyl® ABT	212	Grapa metálica DFT	222
Abrazadera Multiclip UT	213	Grapa metálica PFT	222
Base brida TBB	214	Sujeción cables WSC/WDC	223
Base brida lateral TBBL	214	Suspensión cable AAT	223
Base brida doble TBBD	215	Clavadora a gas FOX	224
Base brida metálica TBM	215	Clavos de acero TKA	225
Base con brida incorporada TBT	216	Bombona gas FOX	225
Arandela plástica Ø16mm AP	216	Cinta textil TXS	226
Espárrago roscado ATR	217	Arandela plástica Ø30mm AP	227
Arandela AW	217		
Tuerca roscada ATV	218		
Sujeción cables TPC-TPLC	219		

Clavadora a gas FORCE ONE



NOVEDAD



Ventajas

- La herramienta más fiable y potente para aplicaciones exigentes.
- Compacta y ligera, permite un buen uso bajo techo.
- El gas va en posición central para un mejor equilibrio, además, se introduce con mayor facilidad, dejándolo caer en la cavidad.
- Facilidad de mantenimiento, con herramienta incluida para desatascar clavos.
- Protección contra el polvo de alto rendimiento para evitar el desgaste interno.

Aplicaciones:

- Fijación de cables, tubo rígido y tubo flexible.
- Fijación de accesorios suspendidos como varilla y manguito.
- Fijación de canaletas y cajas de empalme.
- Fijación de perfil metálico para cartón yeso.

Adecuado para materiales

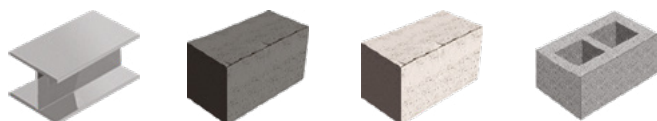

FORCE ONE	Precios	Envase
Código	Precio €/u.	(Uds)
FONE20	1009,00	1
FONE40	1009,00	1

FONE20: cargador de 20 clavos
FONE40: cargador de 40 clavos

Información técnica

	FONE
Medidas generales (DxAxL)	334x124x365 mm
Peso de la herramienta	3,6 Kg (incluye batería y gas)
Retorno automático de la boca	Si
Potencia de clavado	105 J
Capacidad de cargador	20 o 40 clavos
Rango de longitud de clavo	13-38 [mm]



Boca estrecha para perfiles.



Boca reforzada.



Regulador profundidad



Diseño ergonómico



Descubre el sistema de clavadora a gas FORCE ONE

Contenido maletín



- 1 clavadora a gas FORCE ONE.
- 1 cargador de 20 o 40 clavos.
- 2 baterías.
- 1 cargador de batería.
- 2 llaves allen (4 y 5).
- 1 herramienta de desatasco de clavos.
- Gafas de seguridad.
- Tapones protectores oído.
- Manual de usuario.

Clavos de acero XHA

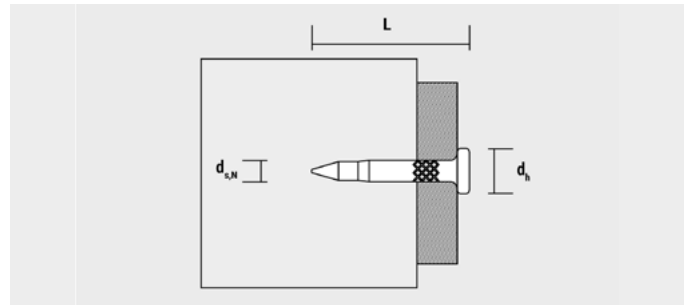

Características

- Clavos reforzados para hormigón duro y viga de acero.
- Las cajas que contienen 800 clavos incluyen una bombona de gas para disparar hasta 1.000 clavos.
- Las cajas que contienen 1.000 clavos incluyen una bombona de gas para disparar hasta 1.200 clavos.

Cajas

XHA Para FORCE ONE			Precios		Envase	Embalaje
d _s [mm]	L _s [mm]	d _h [mm]	Código	Precio €/100 u.	(Uds)	(Uds)
3	13	6,3	913800XHA	37,30	800	4000
3	17	6,3	917800XHA	33,80	800	4000
3	22	6,3	922800XHA	34,20	800	4000
3	27	6,3	927800XHA	36,30	800	4000
3	32	6,3	932800XHA	40,90	800	4000
3	38	6,3	938800XHA	43,30	800	4000

XHA Para AGII			Precios		Envase	Embalaje
d _s [mm]	L _s [mm]	d _h [mm]	Código	Precio €/100 u.	(Uds)	(Uds)
3	13	6,3	9131000XHA	37,30	1000	5000
3	17	6,3	9171000XHA	33,80	1000	5000
3	22	6,3	9221000XHA	34,20	1000	5000
3	27	6,3	9271000XHA	36,30	1000	5000
3	32	6,3	9321000XHA	40,90	1000	5000
3	38	6,3	9381000XHA	43,30	1000	5000



Test center FORCE ONE

Potencia tu punto de venta con nuestro test center.

Más información a info@celofixings.es o contacta con nuestro comercial.

SUJECIÓN

Bombona gas GASFONE



FORCE ONE

Características

- La bombona de gas para la FORCE ONE puede disparar 1000 clavos.

Bombona a gas FORCE ONE	Precios		Envase	Embalaje
	Código	Precio € / u.	(Uds)	(Uds)
Bombona a gas FORCE ONE	9GASFONE	63,10	1	1



Abrazadera Abranyl® ABT



Características

- Multidímetro, una medida cubre tres diámetros.
- Rapidez de instalación.
- Compatible con clavadora FORCE ONE.
- Montaje con perfil 20x10 (1000PVC / 2000PG / 2000PB).
- Marcaje de alineado.
- Más reforzada (20 mm de ancho).
- Libre de halógenos.

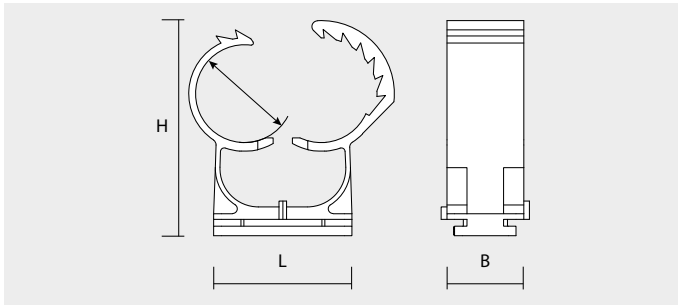

Cajas

ABT Gris				Precios		Envase	Embalaje
Ø [mm]	H [mm]	L [mm]	B [mm]	Código	Precio €/100 u.	(Uds)	(Uds)
14-18	35,6	24	16	918ABT	48,40	100	600
20-25	45,5	29	16	925ABT	57,90	50	450
25-32	53,6	36	16	932ABT	72,70	50	300
35-42	66,4	45	16	942ABT	116,80	25	150

ABT Blanco				Precios		Envase	Embalaje
Ø [mm]	H [mm]	L [mm]	B [mm]	Código	Precio €/100 u.	(Uds)	(Uds)
14-18	35,6	24	16	9118ABT	53,20	100	600
20-25	45,5	29	16	9125ABT	63,90	50	450
25-32	53,6	36	16	9132ABT	80,00	50	300
35-42	66,4	45	16	9142ABT	128,50	25	150

ABT Negro				Precios		Envase	Embalaje
Ø [mm]	H [mm]	L [mm]	B [mm]	Código	Precio €/100 u.	(Uds)	(Uds)
14-18	35,6	24	16	9418ABT	53,20	100	600
20-25	45,5	29	16	9425ABT	63,90	50	450
25-32	53,6	36	16	9432ABT	80,00	50	300
35-42	66,4	45	16	9442ABT	128,50	25	150

Color negro resistente a los rayos UV.

Información Técnica

Ø [mm]	Ø Tubos		
	Hierro	Cobre	Plástico
14-18	3/8"	14-15-18	16
20-25	1/2"	22	20-25
25-32	3/4"	28	32
35-42	1"-1/4"	35-42	40-42

Instalación



Bolsas

ABT Gris		Precios		Envase	Embalaje	Embalaje
Ø [mm]	Código	Precio €/Bolsa	(Uds)	(Bolsas)	(Uds)	
14-18	18ABT	4,00	6	15	90	
20-25	25ABT	4,90	6	15	90	
25-32	32ABT	6,00	6	15	90	
35-42	40ABT	8,10	6	15	90	

Abrazadera Multiclip UT



Características

- Doble sistema de unión lateral para montaje en serie.
- Marcaje de alineado.
- Compatible con clavadora FORCE ONE.
- Montaje con perfil 20x10 (2000PG/PB/PVC).
- Libre halógenos.

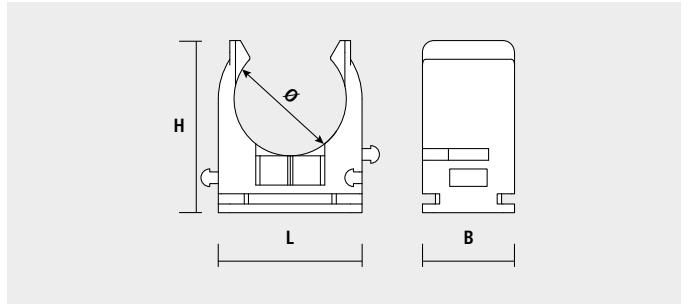

Cajas

UT Gris				Precios		Envase	Embalaje
Ø [mm]	H [mm]	L [mm]	B [mm]	Código	Precio €/100 u.	(Uds)	(Uds)
16	25,5	23	16	916UT	33,00	100	900
20	29,5	25	16	920UT	40,20	100	900
25	34	30,5	16	925UT	48,80	100	900
32	42	38	16	932UT	59,10	50	450
40	50	46	16	940UT	78,30	50	300

Información Técnica

Ø [mm]	Ø Tubos
	Cobre
16	16
20	20
25	25
32	32
40	40

Instalación



SUJECIÓN

Base brida TBB

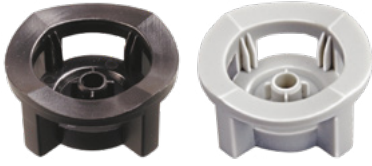

Características

- No hace falta orientarla, apertura por los cuatro costados.
- Admite bridas de hasta 10 mm de ancho.
- Mejor asentamiento de los tubos por su geometría curva.
- Libres de halógenos.

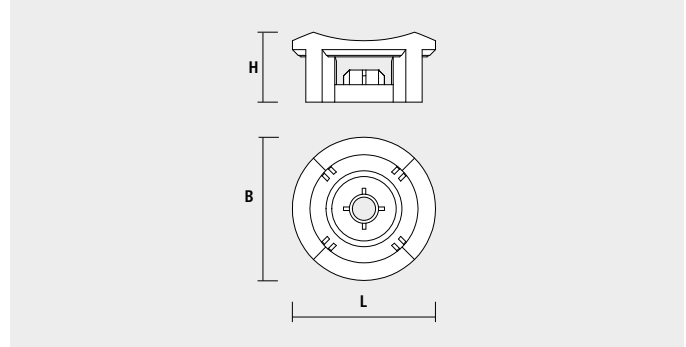

Cajas

TBB Modelo para FORCE ONE y AG				Precios		Envase	Embalaje
H [mm]	L [mm]	B [mm]	Color	Código	Precio €/100 u.	(Uds)	(Uds)
13	24,5	24,5	Negro	9TBB	18,60	100	1200
13	24,5	24,5	Gris	9GRTBB	20,50	100	1200

Instalación



Base brida lateral TBBL



Características

- Accesorio base brida para clavadora a gas con brida incorporada de 4,8x240 mm.
- Brida móvil, se puede adaptar a la posición del tubo.
- Superficie curvada para un mejor asentamiento del tubo.
- Marca para facilitar el alineamiento.

Cajas

TBBL				Precios		Envase	Embalaje
H [mm]	L [mm]	B [mm]	Color	Código	Precio €/100 u.	(Uds)	(Uds)
10	33	20	Negro	94TBBL	43,70	200	-
10	33	20	Gris	9TBBL	43,70	200	-

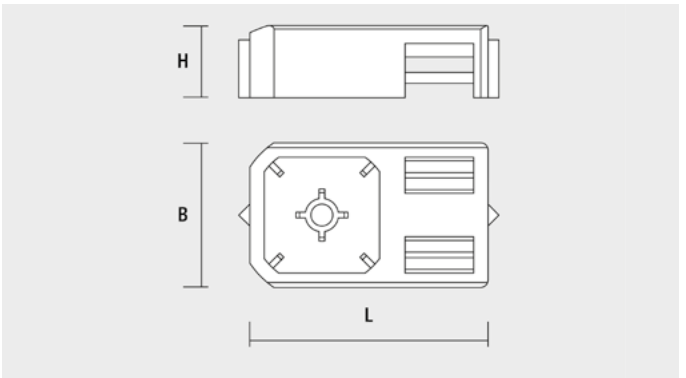

Instalación



Base brida doble **TBBD**



Características

- Admite bridas hasta 10 mm de ancho.
- Marca para alinear en la base para facilitar la instalación.
- Superficie curvada para asegurar un mejor asentamiento del tubo.
- Ideal para instalaciones de dos tubos en paralelo.

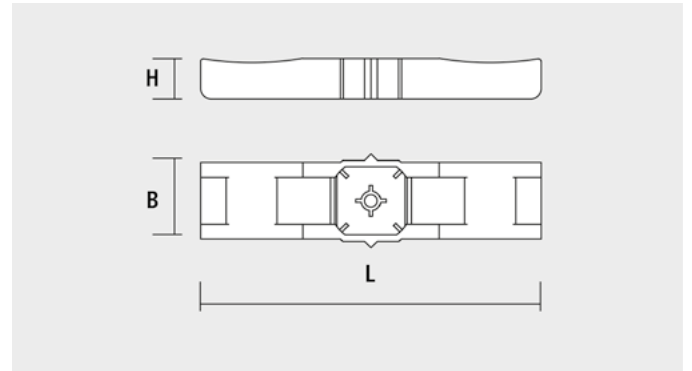

Cajas

TBBD				Precios		Envase	Embalaje
H [mm]	L [mm]	B [mm]	Color	Código	Precio €/100 u.	(Uds)	(Uds)
9,5	80	18	Negro	9TBBD	45,80	100	600

Base brida metálica **TBM**



Características

- Dispone de dos colisos para pasar cable, brida nylon o brida metálica de hasta 13 mm.
- Contiene agujero de Ø 6 mm para fijar con taco y tornillo.
- Marca para centrar el segundo disparo.

Cajas

TBM				Precios		Envase	Embalaje
H [mm]	L [mm]	B [mm]	Código	Precio €/100 u.	(Uds)	(Uds)	
12,5	51	25	9TBM	61,40	100	900	

Instalación

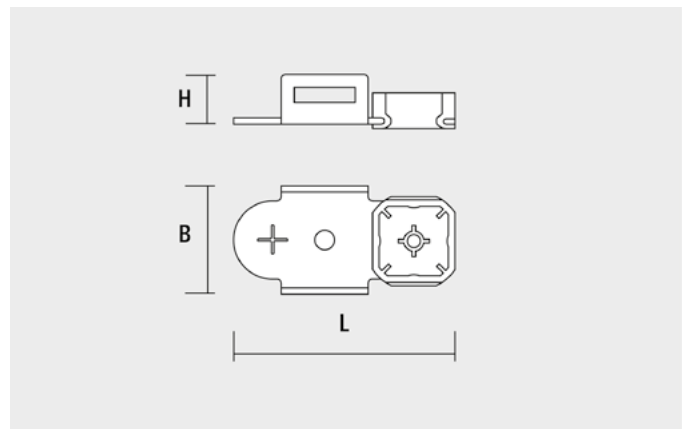

Instalación



Base con brida incorporada **TBT**

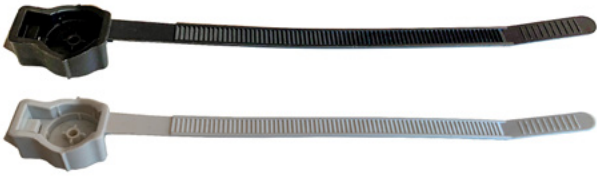

Características

- Cómodo y rápido accesorio de clavadora para fijar tubos.
- Versátil permite fijar tubos de 16 mm a 32 mm.
- Temperatura de instalación -15 °C a +35 °C.
- Resiste temperaturas -40 °C a +85 °C.
- Ajuste a la punta de la clavadora mediante un clip de fricción para un manejo sencillo.
- Resistencia a la tracción 360 N.

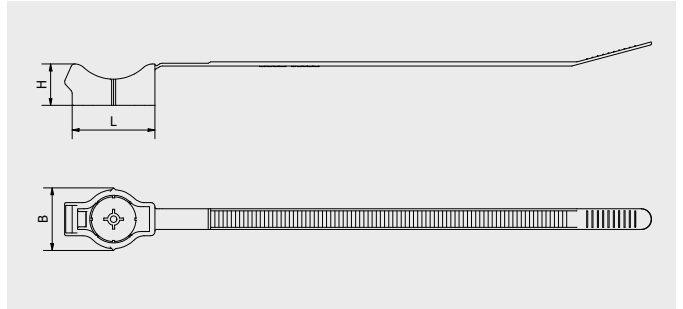

Cajas

TBT					Precios		Envase	Embalaje
H [mm]	L [mm]	B [mm]	Long. Brida [mm]	Color	Código	Precio €/100 u.	(Uds)	(Uds)
15	30	22,7	170	Negro	432TBT	34,00	100	400
15	30	22,7	170	Gris	32TBT	34,00	100	400

Arandela plástica Ø16 mm **AP**



Características

- Arandela plástica de Ø16 mm para fijar sobre materiales plásticos.

Aplicación

- Fijación de canaletas.
- Fijación de cajas de empalme.

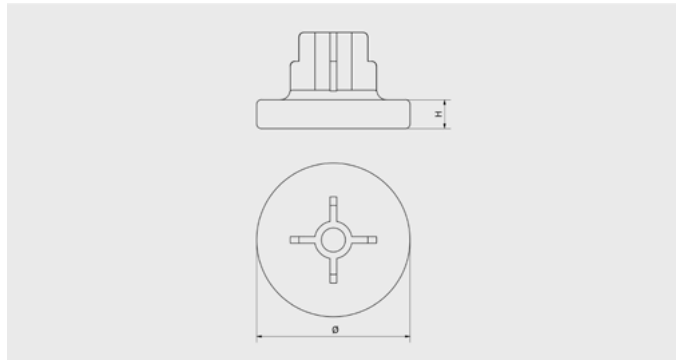

AP		Precios		Envase	Embalaje
H [mm]	Ø [mm]	Código	Precio €/100 u.	(Uds)	(Uds)
3	16	16AP	14,70	100	1000

Espárrago roscado **ATR**

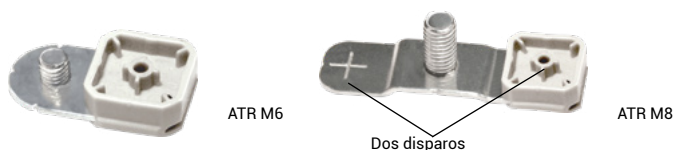

*En combinación con clavo XHA22

Características

- Rapidez de instalación: 10 seg. M6 y 12 seg. M8
- Espárrago soldado garantiza mayor resistencia.
- Marca de alineado en parte metálica.
- Rosca M6 y M8.

Cajas

ATR M6 y M8					Precios		Envase	Embalaje
Ø [mm]	L [mm]	H [mm]	B [mm]	Tornillo	Código	Precio €/100 u.	(Uds)	(Uds)
M6	36	8	20,5	M6x6,5	9TR6	44,80	100	900
M8	64	8	20,5	M8x10	9TR8C	73,60	100	900
M8	64	8	20,5	M8x16	9TR8L	77,60	100	900

ATR M6 y M8			
Ref.	Rosca	Long. espárrago	Resist. recom.
9TR6	M6	6,5	30 Kg
9TR8	M8	10/16	50 kg

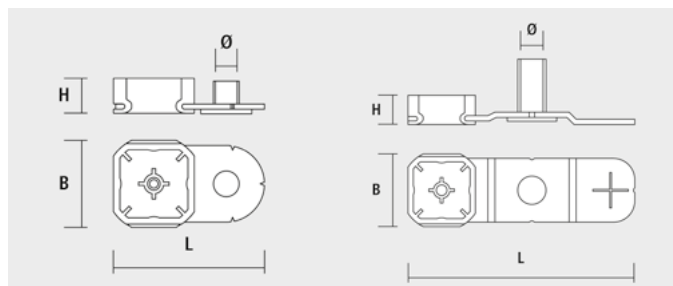

Instalación

ATR 6



ATR 8



Arandela **AW**

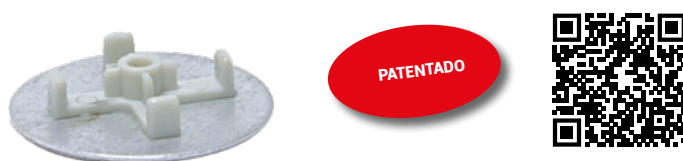

Características

- Queda fijado en la boca y amortigua el impacto del clavo.
- Disponible en: Ø15 y Ø25.

Cajas

AW			Precios		Envase	Embalaje
Ø [mm]	H [mm]	tm [mm]	Código	Precio €/100 u.	(Uds)	(Uds)
15	5	1,0	915AW	20,70	200	3.600
25	5	0,8	925AW	22,70	200	3.600

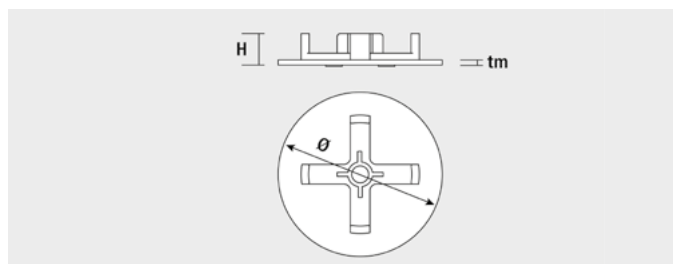

Instalación



SUJECIÓN

Tuerca roscada **ATV**



ATV M4/5/6

ATV M8



ATV M8 Standard



ATV M6



ATV M8



*En combinación con clavo XHA22

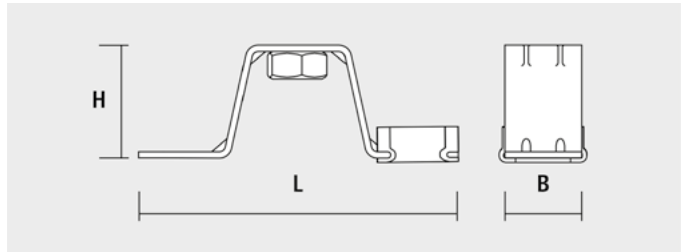
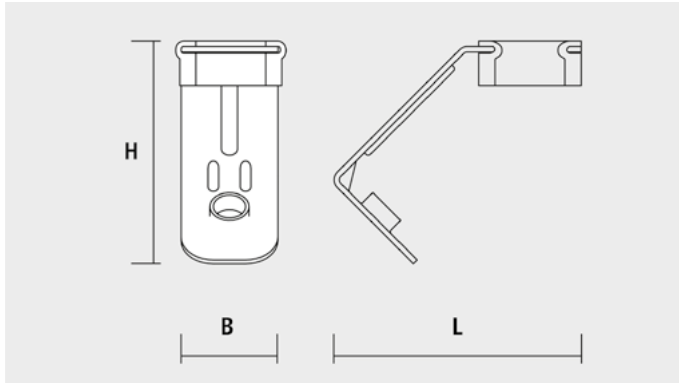

Características

- Rapidez de instalación: 10 segundos M6 y 12 segundos M8.
- En M8 posibilidad de regulación manual.
- Cincado.

Cajas

ATV M6 y M8				Precios		Envase	Embalaje
Ø [mm]	L [mm]	H [mm]	B [mm]	Código	Precio €/100 u.	(Uds)	(Uds)
M4	46	41	18	9TV4	52,60	100	600
M5	46	41	18	9TV5	63,70	100	600
M6	46	41	18	9TV6	73,60	100	600
M8	75	26,5	18	9TV8	129,20	50	450
M8	75	26,5	18	9TVS8	109,50	50	450

Instalación

ATV 4, 5, 6



ATV 8



Sujeción cables TPC - TPLC



TPC



TPLC

PATENTADO

Características

- Para cables 9 x 25.

Cajas

TPC - TPLC				Precios		Envase	Embalaje
Cables	L [mm]	H [mm]	B [mm]	Código	Precio €/100 u.	(Uds)	(Uds)
6x17	44	6	22	9TPC	21,10	100	900
9x25	64,5	11	30	9TPLC	42,20	100	900

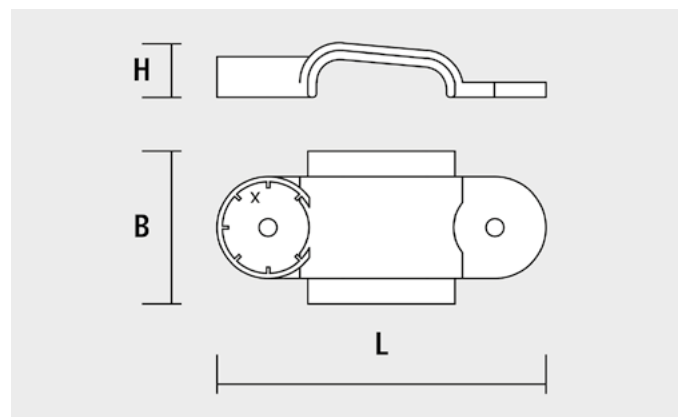

Instalación



Grapa de plástico FPD



PATENTADO

Características

- Multimétrica: cada grapa sujeta 3 diámetros de tubo.
- La grapa clipa el tubo.
- Marcaje de alineado*.
- Rapidez de instalación: 3 segundos.
- Se puede fijar con cualquier clavadora de gas.
- Libre de halógenos.

Cajas

FPD				Precios		Envase	Embalaje
Ø [mm]	L [mm]	H [mm]	B [mm]	Código	Precio €/100 u.	(Uds)	(Uds)
16-18	41,5	18,5	23	916FPD	37,20	100	900
20-22	43,5	20,5	23	920FPD	41,40	50	450
25-28	45,5	22,5	23	925FPD	70,40	50	450

Información Técnica

Ø [mm]	Ø Tubos		
	Cobre	Hierro	Plástico
16-18	18	3/8"	16
20-22	22	1/2"	20
25-28	28	3/4"	25

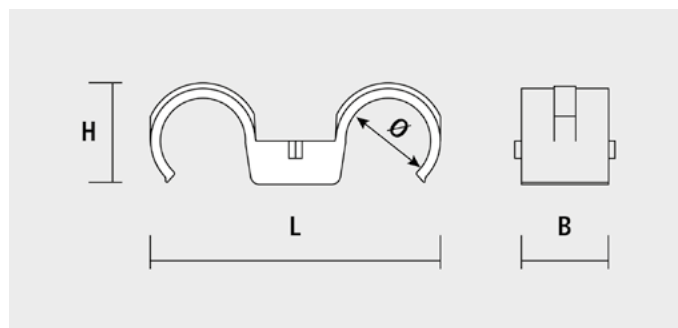

Instalación



Grapa de plástico FP



Características

- La grapa clipa el tubo.
- Rapidez de instalación: 3 segundos.
- Se puede fijar con cualquier clavadora de gas.
- Libre de halógenos

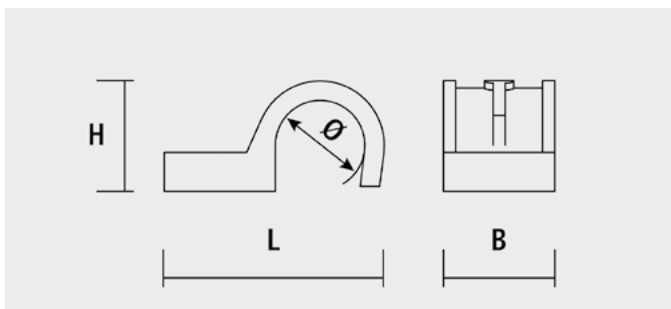

Cajas

FP				Precios		Envase	Embalaje
Ø [mm]	L [mm]	H [mm]	B [mm]	Código	Precio €/100 u.	(Uds)	(Uds)
16	41,5	18,5	23	916FP	22,30	100	900
18	43,5	20,5	23	918FP	24,90	100	900
20	45,5	22,5	23	920FP	26,80	100	600
22	47,5	24,5	23	922FP	29,30	100	600
25	50,5	27,5	23	925FP	30,60	100	600
28	53,5	30,5	23	928FP	36,20	100	600
32	57,5	34,5	23	932FP	39,20	50	450

Información Técnica

Ø [mm]	Ø Tubos		
	Cobre	Hierro	Plástico
16	-	-	16
18	18	3/8"	-
20	-	-	20
22	22	1/2"	-
25	-	-	25
28	28	3/4"	-
32	-	-	32

Instalación



Abrazadera metálica para mazos de cables CHS



94741CHS



93587CHS

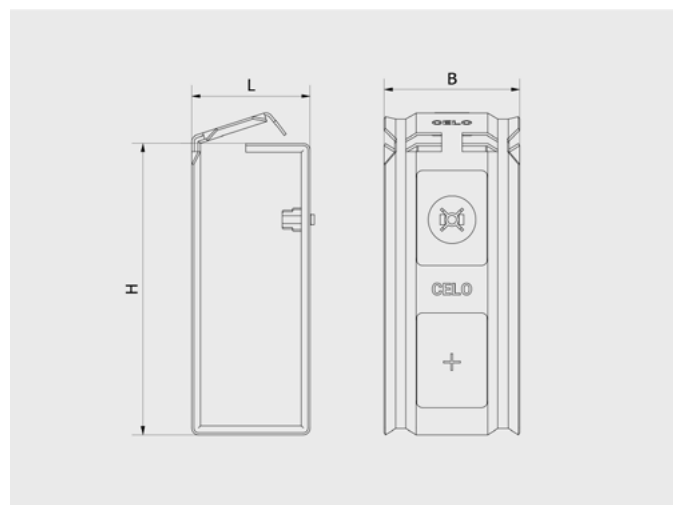
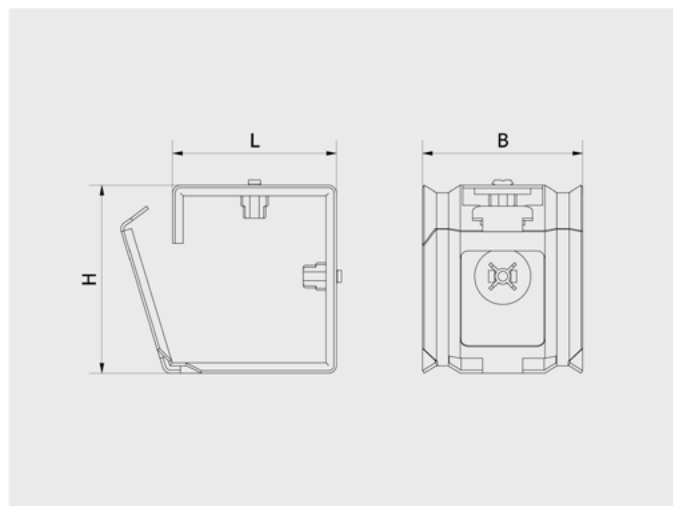

Características

- Rápido sistema de instalar cables de diferentes grosores.
- Permite ampliar la instalación fácilmente gracias a la acceso lateral de la abrazadera.
- Se puede utilizar tanto en techo como en paredes.
- Ajuste a la punta de la clavadora mediante un clip de fricción para un manejo sencillo.
- Homologada al fuego.
- Abrazadera de acero galvanizado.
- Sistema con suficiente distancia de separación para una instalación económica.

Aplicación

- Instalación de mazos de cables.
- Instalación de cables en vías de escape.
- Iluminación de emergencia, sistema de ventilación de humos, sistema de aspersores, ascensores de bomberos, etc.

CHS			Precios		Envase	Embalaje
H [mm]	L [mm]	B [mm]	Código	Precio €/100 u.	(Uds)	(Uds)
41	47	40	94741CHS	89,60	100	-
87	35	40	93587CHS	106,60	50	-

Cargas recomendadas F_{Rec} [kN]

Distancia entre abrazaderas [cm]	30	40	50	60	70	80
Carga máx. rec. por abrazadera [kg] ≤	≤ 6 (1)	≤ 4,5	≤ 3,6	≤ 3	≤ 2,6	≤ 2,3

⁽¹⁾ La capacidad máxima de carga es de 6 kg/m. Se recomienda instalar con una separación de 30 cm a 60 cm, dependiendo de la rigidez del cable.

Instalación

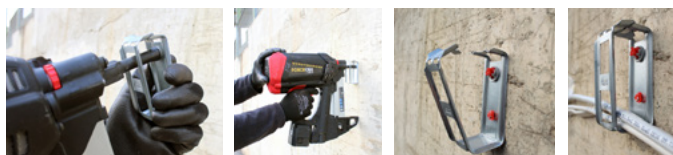

SUJECIÓN

Grapa metálica DFT

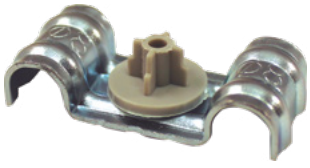

*En combinación con clavo XHA 17 / 22



Características

- La grapa clipa el tubo / cable.
- Rapidez de instalación: 3 segundos.
- Homologada al fuego.

Cajas

DFT				Precios		Envase	Embalaje
Ø [mm]	L [mm]	H [mm]	B [mm]	Código	Precio €/100 u.	(Uds)	(Uds)
6	37	7,5	17	96DFT	31,50	100	1.800
8	40	9	17	98DFT	34,70	100	900
10	44	11	17	910DFT	36,20	100	900
12	48	13	17	912DFT	38,50	100	900

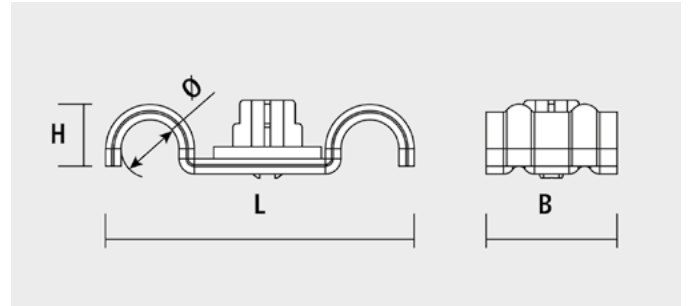

Información Técnica

Ø [mm]	Ø Tubos	
	Cobre	Hierro
6	6	-
8	8	-
10	10	1/8"
12	12	-

Instalación



Grapa metálica PFT



*En combinación con clavo XHA 17 / 22



Características

- La grapa clipa el tubo / cable.
- Rapidez de instalación: 3 segundos.
- Homologada al fuego.

Cajas

PFT				Precios		Envase	Embalaje
Ø [mm]	L [mm]	H [mm]	B [mm]	Código	Precio €/100 u.	(Uds)	(Uds)
6	26,0	7,5	17	96PFT	26,10	100	1.800
8	27,5	9,0	17	98PFT	27,20	100	1.800
10	29,5	11,0	17	910PFT	29,30	100	1.800
12	31,5	13,5	17	912PFT	32,10	100	1.800
14	33,5	15,5	17	914PFT	34,80	100	1.800

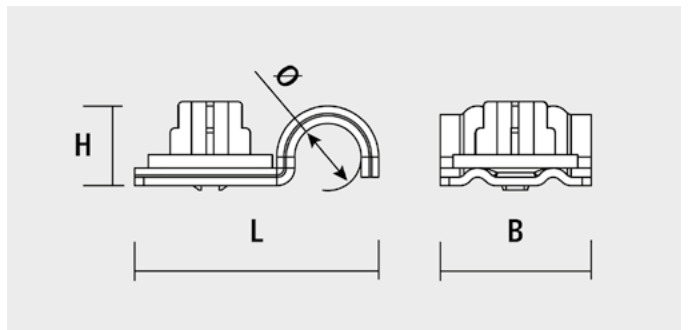

Información Técnica

Ø [mm]	Ø Tubos	
	Cobre	Hierro
6	6	-
8	8	-
10	10	1/8"
12	12	-
14	14	-

Instalación



Sujeción cables WSC / WDC

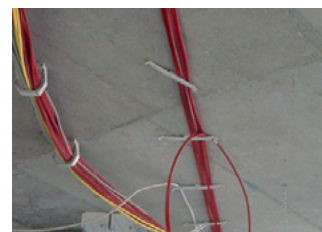

Características

- Posibilidad de montaje con taco y tornillo (FX6 + TG32).
- Fácil introducción de los cables y correcta fijación gracias al efecto pinza.
- Libre de halógenos. Rohs conforme.
- Fijación de cables en suelos técnicos y bajo techo.

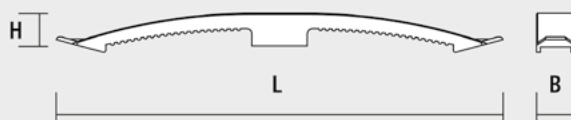
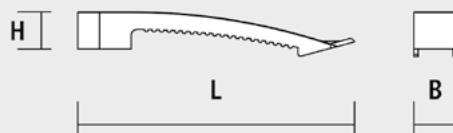

Cajas

WSC /WDC				Precios		Envase	Embalaje
Denom.	L [mm]	H [mm]	B [mm]	Código	Precio €/100 u.	(Uds)	(Uds)
WSC	127	17	20	9WSC	101,30	100	900
WDC	234	17	20	9WDC	155,40	50	450

Instalación

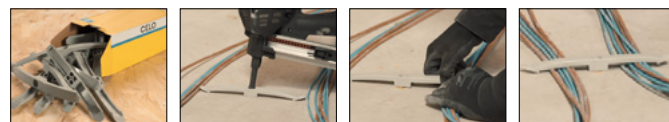

Suspension cable AAT



*En combinación con clavo XHA 17 / 22



Características

- Rapidez de instalación 10-15 segundos.
- Agujero de 7 mm.
- Fijación de cables de acero para suspensión de carteles y luminarias. Fijación de falsos techos.

Cajas

AAT			Precios		Envase	Embalaje
L [mm]	H [mm]	B [mm]	Código	Precio €/100 u.	(Uds)	(Uds)
27	26	18	9AAT	46,40	100	900

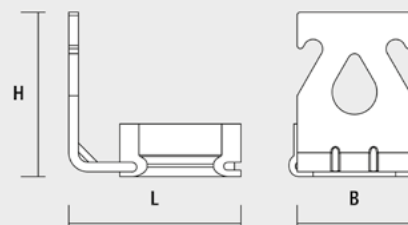
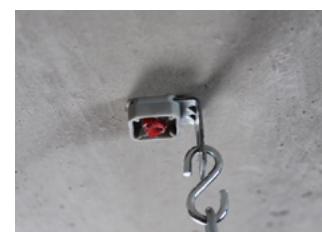

Instalación



Clavadora a gas FOX



Ventajas

- Dos veces más rápida que las clavadoras eléctricas.
- Más ligera que las clavadoras eléctricas.
- Asegura siempre la misma profundidad de clavado, para una fijación de calidad.
- Buena accesibilidad en cualquier zona gracias a un diseño de boca delgada.

Aplicaciones:

- Perfiles metálicos para fijar cartón yeso.
- Fijación de hueveras y malla.
- Fijación de cinta textil.

Adecuado para materiales

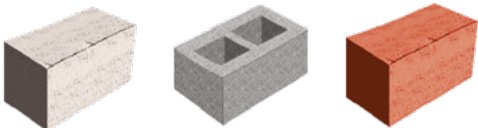

Protección contra el polvo



Ajuste de profundidad



Gancho ajustable



Diseño ergonómico

FOX	Precios	Envase
Código	Precio €/u.	(Uds)
FOX40	642,00	1

Información técnica

Características	Datos técnicos
Alto	385 mm
Ancho	130 mm
Profundidad	327 mm
Peso	3,8 Kg (incluye batería y gas)
Capacidad cargador	FOX 20: 20 + 2 clavos* FOX 40: 40 + 2 clavos*
Tipo de batería	Batería de Li-iON
Capacidad de la batería	2.500 mAh
Cargador de conexión	100-240V AC. (50 o 60Hz)
Tiempo de carga	90 min de carga completa
Rango de temperatura de uso	0°C a 50°C

* Debe haber al menos 2 clavos en el cargador, de lo contrario no se puede disparar la clavadora.



Contenido maletín

- 1 x clavadora a gas FOX
- 1 x gafas protectoras
- 2 x tapones
- 2 x baterías de li-ion
- 1 x cargador
- 1 x maletín
- 1 x manual de seguridad

Clavos de acero TKA

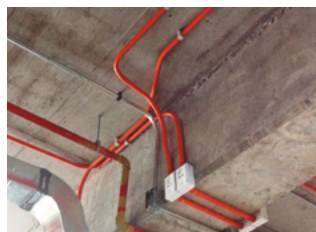

Características

- Las cajas que contienen 1.000 clavos incluyen una bombona de gas para disparar hasta 1.200 clavos.

Cajas

TKA para FOX			Precios		Envase	Embalaje
d_s [mm]	L_s [mm]	d_h [mm]	Código	Precio € / 100 u.	(Uds)	(Uds)
2,6	15	6,3	9151000TKA	27,30	1000	5000
2,6	19	6,3	9191000TKA	24,00	1000	5000
2,6	25	6,3	9251000TKA	24,00	1000	5000
2,6	30	6,3	9301000TKA	27,30	1000	5000
2,6	40	6,3	9401000TKA	32,70	1000	5000

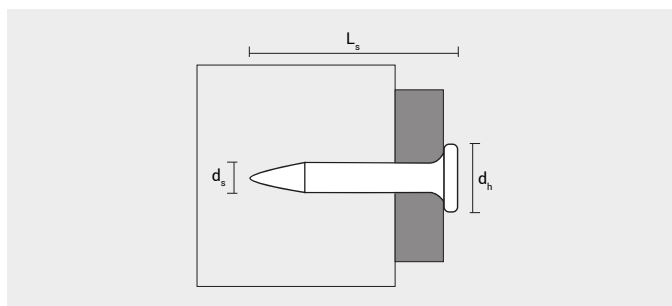

Bombona gas FOX



FOX



Características

- La bombona de gas para la FOX puede disparar 1200 clavos.

Bombona a gas para FOX	Precios		Envase	Embalaje
	Código	Precio € / u.	(Uds)	(Uds)
Bombona a gas FOX	91GASA	63,10	1	20

* Válvula adaptable a bombona para disparos en altitud (+2500 metros).

Cinta textil **TXS**



Características

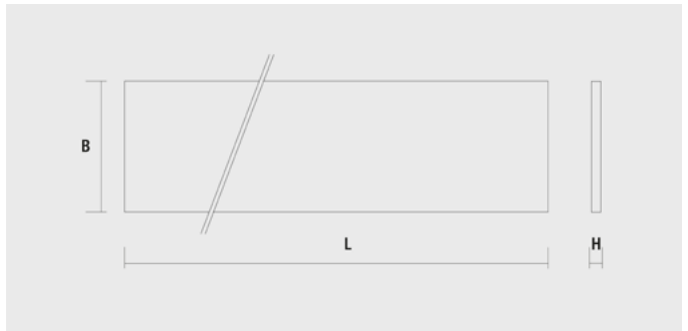

- Fijación rápida y rentable, se pueden sujetar varios tubos o conductos a la vez.
- No daña el tubo gracias a la ausencia de bordes.
- Posibilidad de fijar varias tuberías o conductos al suelo en paralelo.
- Evita la rotura del tubo coarrugado cuando se estira del tubo.
- Resistente al óxido.
- La medida de 19 mm está fabricada en PS (Poliestireno) y resiste a temperaturas de -40 °C a +170 °C con una carga máxima de 5 kN.
- La medida de 15 mm está fabricada en PP (Polipropileno) y resiste a temperaturas de -10 °C a +120 °C con una carga máxima de 2 kN.
- Resistente al óxido.
- Rollos de 10 metros.





Aplicación

- Mazos de cables y conductos.
- Tuberías ligeras.
- Fijación de tubos a suelos para instalaciones de fontanería y calefacción.

Cajas

TXS Negro			Precios		Envase	Embalaje
L [mm]	H [mm]	B [mm]	Código	Precio € / rollo	 (Uds)	 (Uds)
10.000	1,25	19	9419TXS	12,90	1	8

TXS Gris			Precios		Envase	Embalaje
L [mm]	H [mm]	B [mm]	Código	Precio € / rollo	 (Uds)	 (Uds)
10.000	1,00	15	915TXS	9,90	1	10

Arandela plástica Ø30 mm AP





Características

- Arandela blanda para la fijación de membranas resistentes al agua en hormigón o mampostería.
- Mayor superficie de carga que incrementa la calidad de la fijación del material.

Aplicación

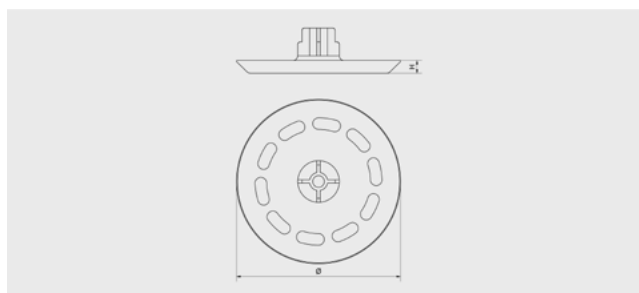
- Fijación de membranas, plásticos o materiales frágiles.
- Fijación de mallas de alambre.
- Fijación de aislantes de bajo espesor.



AP		Precios		Envase	Embalaje
H [mm]	Ø	Código	Precio €/100 u.	 (Uds)	 (Uds)
2,75	35,5	30AP	18,00	100	-

Tornillería

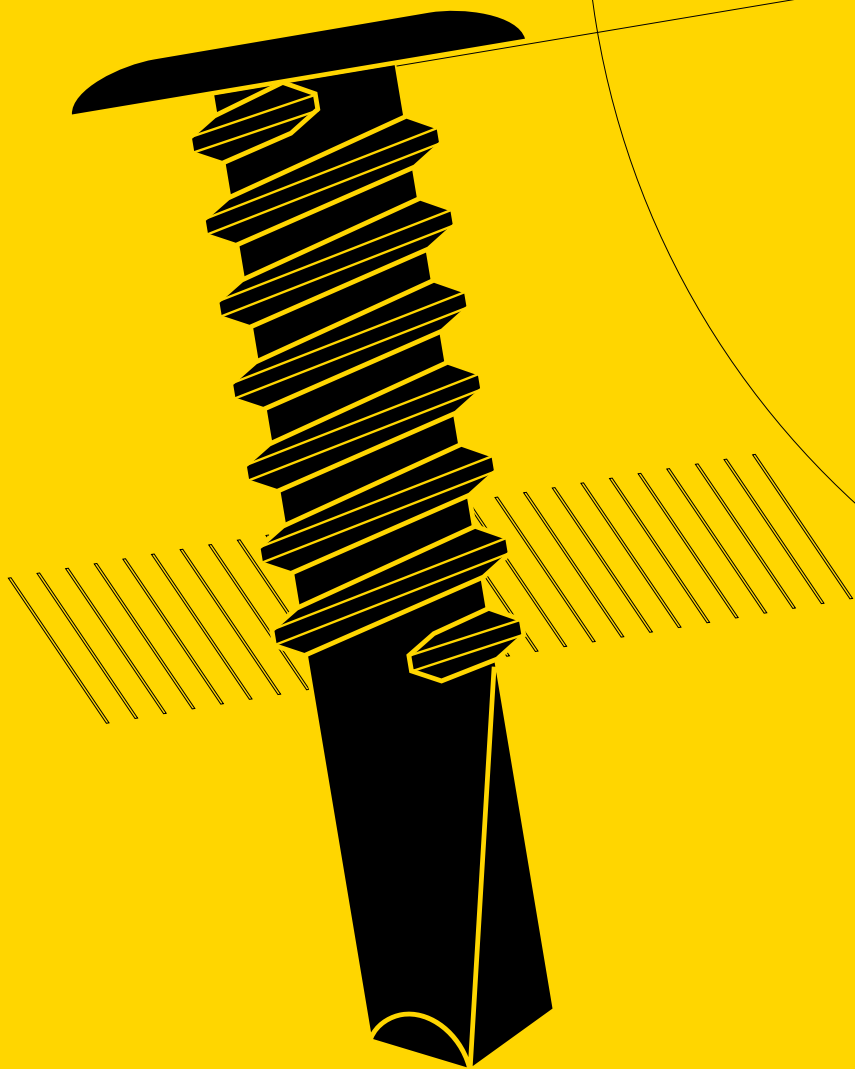

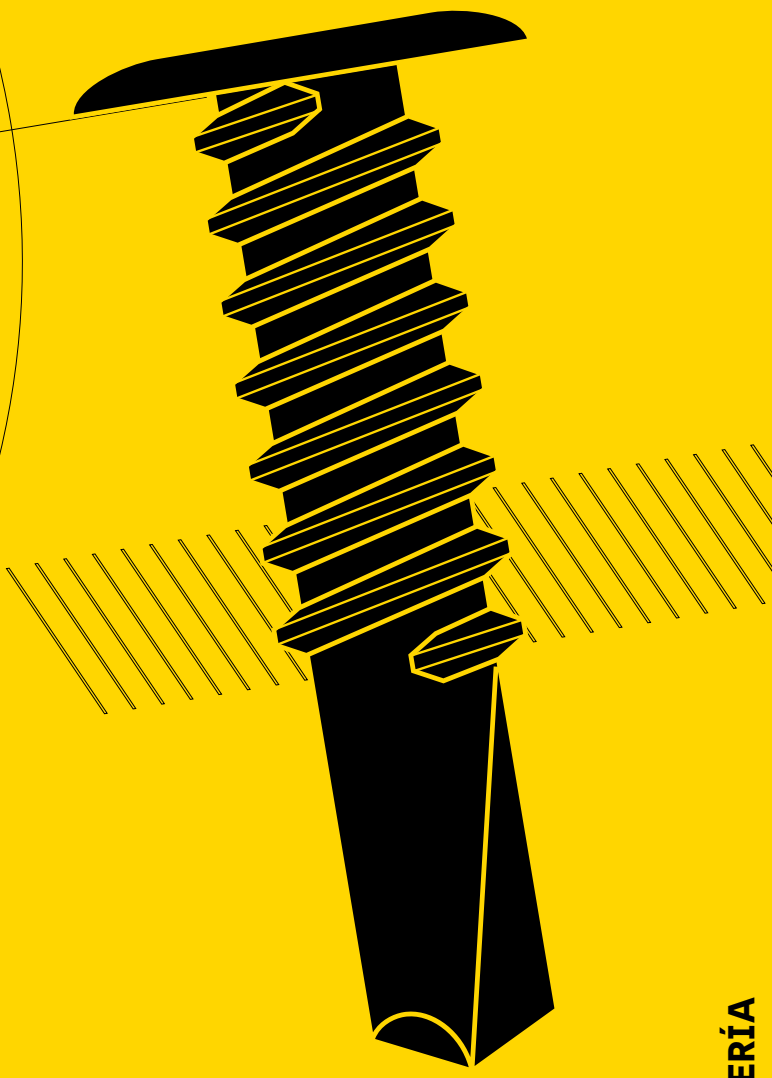

TORNILLERÍA

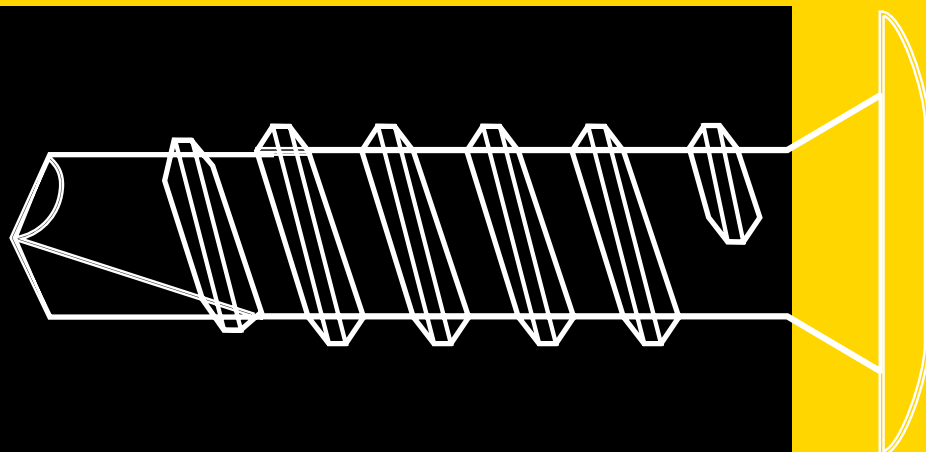

Tornillos rosca chapa y punta broca

Tornillo DIN 7981	232
Tornillo DIN 7981F	235
Tornillo TORX® 7049	236
Tornillo DIN 7982	237
Tornillo DIN 7982F	239
Tapón estrella zamak TZ	240
Tornillo DIN 7983	241
Tornillo CH88H	242
Tornillo cabeza alomada SIT 7049S	243
Tornillo cabeza avellanada SIT 7061	244
Tornillo cabeza botón BTN	244
Tornillo cabeza reducida FCE	245
Tornillo cabeza extraplana CE	246
Tornillo cabeza extraplana FM	247
Tapón extraplano EFM	247
Tornillo cabeza baja FS	248
Tornillo para tapón NICE	249
Tapón pincho NICEN / NICEC / NICEB	249
Tornillo cabeza envolvente CAHP	250
Tornillo panel sandwich PG	251
Tapón embellecedor CAT/ Tapón envolvente T12	251
Tornillo DIN 7981-0	252
Tornillo junquillo ranura CHJ/RJ/CHJH	253
Tornillo unión de montantes PV70	253
Tornillo broca cabeza extraplana CET	254

Tornillo broca cabeza ancha 75HA	255
Tornillo broca alomado SIT® A85S	256
Tornillo broca avellanado SIT A61S	257
Tornillo DIN 7504N	258
Tornillo broca reducida ALUN	260
Tapón embellecedor TN	261
Tornillo DIN 7504P	262
Tornillo DIN 7504K	263
Tornillo 7301	264
Tornillo broca TX inviolable A85TI	265
Tornillo broca botón BTT	266
Tornillo broca cabeza baja FST	267
Tornillo broca reducida ALFST	268
Tornillo broca paso fino HM	269
Tornillo broca reducida ALUH	270
Tornillo matrícula TECPLAS	270
Punta broca p/montantes PV72	271
Tapón unión de montantes PV71	271
Tornillo para perfil de PVC RH/KO/VK/TY	271
Tornillo para PVC, rosca chapa punta broca PVS	272
Tornillo para PVC, rosca métrica punta broca PVM	272
Tornillo para PVC, rosca plástico PVP	273
Diámetros del agujero para tornillos rosca chapa	274

Tornillo DIN 7981



Cincado

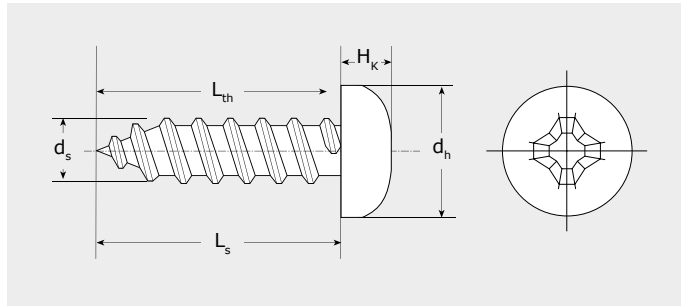

d_s : Diámetro tornillo L_{th} : Parte roscada. H_k : Altura de cabeza.
 L_s : Longitud tornillo. d_h : Diámetro cabeza.

Características

- Cabeza alomada.
- Impronta Philips (PH).
- Punta forma C.

Cajas

DIN 7981 Cincado						Precios		Envase	Embalaje
d_s [mm]	L_s [mm]	L_{th} [mm]	d_h [mm]	H_k [mm]	Impronta	Código	Precio €/100 u.	(Uds)	(Uds)
2,2	6,5	T	4,2	1,8	PH1	922657981	2,30	1.000	24.000
	9,5					922957981	2,30	1.000	24.000
	13					922137981	2,40	1.000	24.000
	16					922167981	2,40	1.000	24.000
2,9	6,5	T	5,6	2,2	PH1	929657981	1,60	1.000	24.000
	9,5					929957981	1,60	1.000	24.000
	13					929137981	1,70	1.000	24.000
	16					929167981	1,90	1.000	12.000
	19					929197981	2,20	1.000	12.000
	22					929227981	2,40	1.000	12.000
	25					929257981	2,60	500	60.000
3,3	9,5	T	6,2	2,3	PH2	933957981	1,80	1.000	24.000
	16					933167981	2,20	500	12.000
	25					933257981	2,20	500	6.000
3,5	6,5	T	6,9	2,6	PH2	935657981	1,90	1.000	24.000
	9,5					935957981	1,60	1.000	24.000
	13					935137981	1,70	500	12.000
	16					935167981	2,10	500	12.000
	19					935197981	2,50	500	6.000
	22					935227981	2,80	500	6.000
	25					935257981	3,20	250	6.000
	32					935327981	3,70	250	6.000
	38					935387981	4,20	250	3.000
3,9	6,5	T	7,5	2,8	PH2	939657981	2,20	500	12.000
	9,5					939957981	2,20	500	12.000
	13					939137981	2,30	500	12.000
	16					939167981	2,50	500	6.000
	19					939197981	2,80	500	6.000
	22					939227981	3,20	250	6.000
	25					939257981	3,60	250	6.000
	32					939327981	4,10	250	3.000
	38					939387981	4,50	250	3.000
	45					939457981	5,90	250	3.000
4,2	9,5	T	8,2	3,05	PH2	942957981	2,30	500	12.000
	13					942137981	2,30	500	12.000
	16					942167981	2,70	500	6.000
	19					942197981	3,00	500	6.000
	22					942227981	3,50	250	6.000
	25					942257981	3,50	250	6.000
	32					942327981	4,50	250	3.000
	38					942387981	5,30	250	3.000
	45					942457981	6,50	250	2.000
	50					942507981	8,10	250	2.000
	60					942607981	10,30	250	1.500
70					942707981	11,70	250	2.000	
4,8	9,5	T	9,5	3,55	PH2	948957981	3,60	500	6.000
	13					948137981	3,50	500	6.000
	16					948167981	3,80	250	6.000
	19					948197981	4,20	250	6.000
	22					948227981	4,50	250	3.000
	25					948257981	4,50	250	3.000
	32					948327981	5,70	250	3.000
	38					948387981	6,50	500	3.000
	38					948387981200	7,10	200	2.400

Cajas

DIN 7981 Cincado						Precios		Envase	Embalaje
d_s [mm]	L_s [mm]	L_{th} [mm]	d_h [mm]	H_k [mm]	Impronta	Código	Precio €/100 u.	(Uds)	(Uds)
4,8	45	T	9,5	3,55	PH2	948457981	8,40	250	1.500
	50					948507981	9,60	250	1.500
	50					948507981100	10,60	100	1.200
	60					948607981	11,90	250	2.000
	70					948707981	13,60	100	800
	80					948807981	18,10	100	1.200
	90	P				948907981	23,30	100	400
	100					9481007981	25,80	100	800
	110					9481107981	30,80	100	800
	120					9481207981	36,60	50	300
140					9481407981	61,60	100	400	
5,5	13	T	10,8	3,95	PH3	955137981	4,40	250	6.000
	16					955167981	4,80	250	6.000
	19					955197981	5,20	250	3.000
	22					955227981 ¹	5,90	250	3.000
	25					955257981	5,80	250	3.000
	32					955327981	7,80	250	3.000
	38					955387981	8,40	250	2.000
	45					955457981	9,80	250	1.500
	50					955507981	10,90	250	1.500
	50					955507981100	12,00	100	1.600
	60					955607981	15,70	100	800
	70					955707981	17,80	100	1.200
80					955807981	24,00	100	1.200	
90	P				955907981	26,50	100	400	
100					9551007981	31,40	100	800	
120					9551207981	45,50	100	800	
6,3	16	T	12,5	4,55	PH3	963167981	6,80	250	3.000
	19					963197981	7,50	250	3.000
	25					963257981	9,20	250	3.000
	32					963327981	11,40	250	1.500
	38					963387981	12,60	250	1.500
	50					963507981	17,30	250	1.200
	60					963607981	20,70	100	600
	70					963707981	22,80	100	600
80					963807981	33,90	100	600	

T Rosca total
 P Rosca parcial
¹ No cumple la normativa RoHS



Cincado Negro

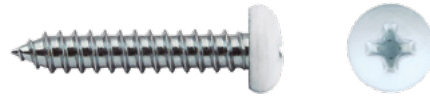

Lacado Blanco



Cajas

DIN 7981 Cincado Negro						Precios		Envase	Embalaje
d _s [mm]	L _s [mm]	L _{th} [mm]	d _h [mm]	H _k [mm]	Impronta	Código	Precio €/100 u.	(Uds)	(Uds)
2,9	9,5	T	5,6	2,2	PH1	9N29957981	2,30	1.000	24.000
	13					9N29137981	2,50	1.000	24.000
	16					9N29167981	2,70	1.000	12.000
	19					9N29197981	3,10	1.000	12.000
	22					9N29227981	3,70	1.000	12.000
3,5	6,5	T	6,9	2,6	PH2	9N35657981	2,80	1.000	24.000
	9,5					9N35957981	2,40	1.000	24.000
	13					9N35137981	2,50	500	12.000
	16					9N35167981	3,10	500	12.000
	19					9N35197981	3,80	500	6.000
	25					9N35257981	4,80	250	6.000
	38					9N35387981	6,40	250	3.000
3,9	9,5	T	7,5	2,8	PH2	9N39957981	3,20	500	12.000
	13					9N39137981	3,60	500	12.000
	16					9N39167981	3,80	500	12.000
	19					9N39197981	4,30	500	6.000
	25					9N39257981	5,20	250	6.000
4,2	9,5	T	8,2	3,05	PH2	9N42957981	3,60	500	12.000
	13					9N42137981	3,60	500	12.000
	16					9N42167981	4,10	500	6.000
	19					9N42197981	4,40	500	6.000
	22					9N42227981	5,20	250	6.000
	25					9N42257981	5,20	250	6.000
	32					9N42327981	6,90	250	3.000
	38					9N42387981	8,10	250	3.000
4,8	13	T	9,5	3,55	PH2	9N48137981	5,20	500	6.000
	16					9N48167981	5,70	500	6.000
	19					9N48197981	6,40	500	6.000
	22					9N48227981	6,90	250	3.000
	25					9N48257981	7,30	250	3.000
	32					9N48327981	8,60	250	3.000
	38					9N48387981	9,80	250	3.000
	50					9N48507981	14,40	250	1.500
	60					9N48607981	17,90	250	1.500
	70					9N48707981	20,20	100	800
	90	P				9N48907981	34,80	100	1.200
5,5	16	T	10,8	3,95	PH3	9N55167981	7,20	250	6.000
	19					9N55197981	8,00	250	3.000
	22					9N55227981	8,90	250	3.000
	25					9N55257981	8,90	250	3.000
	38					9N55387981	12,70	250	2.000
	60					9N55607981	23,40	100	800
	70					9N55707981	26,60	100	1.200

T Rosca total
P Rosca parcial

Cajas

DIN 7981 Lacado Blanco						Precios		Envase	Embalaje
d _s [mm]	L _s [mm]	L _{th} [mm]	d _h [mm]	H _k [mm]	Impronta	Código	Precio €/100 u.	(Uds)	(Uds)
4,2	13	T	8,2	3,05	PH2	9W42137981	8,60	500	12.000
	16					9W42167981	8,90	500	6.000
	19					9W42197981	8,90	500	6.000
	25					9W42257981	10,70	250	6.000
	38					9W42387981	14,50	250	3.000
4,8	38	T	9,5	3,55	PH2	9W48387981	16,70	500	3.000
5,5	19	T	10,8	3,95	PH3	9W55197981 ¹	13,00	250	3.000
	22					9W55227981*	13,50	250	4.000
	25					9W55257981*	14,60	250	4.000
	50					9W55507981	26,60	250	1.500
	60					9W55607981*	32,00	100	800

T Rosca total
P Rosca parcial
¹ No cumple la normativa Rohs
* Hasta fin de existencias.



Acero Inoxidable A2









Cajas

DIN 7981 Acero Inoxidable A2						Precios		Envase	Embalaje
d _s [mm]	L _s [mm]	L _{th} [mm]	d _h [mm]	H _k [mm]	Impronta	Código	Precio €/100 u.	(Uds)	(Uds)
3,5	9,5	T	6,9	2,6	PH2	9X35957981	7,30	1000	24.000
	13					9X35137981	7,30	500	12.000
3,9	13	T	7,5	2,8	PH2	9X39137981	8,60	500	12.000
4,2	13	T	8,2	3,05	PH2	9X42137981	9,50	500	12.000
	16					9X42167981	10,40	500	6.000
	19					9X42197981	11,20	500	6.000
	22					9X42227981	13,00	250	6.000
	25					9X42257981	13,90	250	6.000
	38					9X42387981	17,90	250	3.000
	50					9X42507981	23,70	250	2.000
4,8	13	T	9,5	3,55	PH2	9X48137981	12,70	500	6.000
	16					9X48167981	14,50	250	6.000
	19					9X48197981	15,70	250	6.000
	25					9X48257981	18,40	250	3.000
	32					9X48327981	21,20	250	3.000
	38					9X48387981	23,10	500	3.000
	45					9X48457981	26,10	250	1.500
	50					9X48507981	30,20	250	1.500
	60					9X48607981	34,60	1.200	200
	70					9X48707981	44,80	100	800
	80					9X48807981	53,90	100	1.200
	90					9X48907981	70,00	400	50
	100					9X481007981	73,10	100	1.200
	120					9X481207981	75,50	50	300
5,5	13	T	10,8	3,95	PH3	9X55137981	18,40	250	6.000
	19					9X55197981	21,40	250	3.000
	25					9X55257981	24,50	250	3.000
	32					9X55327981*	28,50	250	4.000
	50					9X55507981	40,30	250	1.500
	60					9X55607981	49,70	100	800
	70					9X55707981	58,40	100	1.200

T Rosca total
P Rosca parcial
* Hasta fin de existencias.

Blister

DIN 7981 Cincado		Precios		Envase	Embalaje	Embalaje
d _s [mm]	L _s [mm]	Código	Precio €/Blister	 (Uds)	 (Blisters)	 (Uds)
3,5	9,5	735957981	3,20	45	10	450
	9,5	435957981	6,30	200	10	2000
	13	735137981	3,20	40	10	400
	13	435137981	6,30	160	10	1600
	16	735167981	3,20	35	10	350
3,9	19	735197981	3,20	30	10	300
	9,5	739957981	3,20	40	10	400
	13	739137981	3,20	35	10	350
	13	439137981	6,30	150	10	1500
	16	739167981	3,20	30	10	300
4,2	19	739197981	3,20	25	10	250
	25	739257981	3,20	20	10	200
	9,5	742957981	3,20	30	10	300
	13	742137981	3,20	25	10	250
	13	442137981	6,30	120	10	1200
	16	742167981	3,20	25	10	250
	16	442167981	6,30	120	10	1200
	19	742197981	3,20	20	10	200
	22	742227981	3,20	15	10	150
	25	742257981	3,20	15	10	150
	25	442257981	6,30	95	10	950
4,8	32	742327981	3,20	15	10	150
	32	442327981	6,30	60	10	600
	38	742387981	3,20	10	10	100
	13	448137981	6,30	110	10	1100
	13	748137981	3,20	20	10	200
	16	748167981	3,20	20	10	200
	19	748197981	3,20	15	10	150
	22	748227981	3,20	15	10	150
	25	748257981	3,20	15	10	150
	25	448257981	6,30	70	10	700
	32	748327981	3,20	10	10	100
32	448327981	6,30	60	10	600	
38	748387981	3,20	10	10	100	
38	448387981	6,30	50	10	500	
45	748457981	3,20	10	10	100	
50	748507981	6,30	8	10	80	
50	448507981	3,20	35	10	350	
5,5	16	755167981	3,20	15	10	150
	19	755197981	3,20	15	10	150
	25	755257981	3,20	10	10	100
	32	755327981	3,20	10	10	100
	38	755387981	3,20	10	10	100
	38	455387981	6,30	40	10	400
	45	755457981	3,20	5	10	50
	50	755507981	3,20	5	10	50
60	755607981	3,20	5	10	50	
60	455607981	6,30	25	10	250	

DIN 7981 Inox. A2		Precios		Envase	Embalaje	Embalaje
d _s [mm]	L _s [mm]	Código	Precio €/Blister	 (Uds)	 (Blisters)	 (Uds)
3,5	13	7X35137981	3,20	25	10	250
	19	7X35197981	3,20	20	10	200
4,2	13	7X42137981	3,20	20	10	200
	16	7X42167981	3,20	20	10	200
	19	7X42197981	3,20	15	10	150
	25	7X42257981	3,20	15	10	150
4,8	16	7X48167981	3,20	10	10	100
	19	7X48197981	3,20	10	10	100
	25	7X48257981	3,20	10	10	100
	38	7X48387981	3,20	5	10	50
	50	7X48507981	3,20	5	10	50
	60	7X48607981	3,20	5	10	50
5,5	19	7X55197981	3,20	10	10	100
	25	7X55257981	3,20	8	10	80
	32	7X55327981	3,20	5	10	50

Bolsas

DIN 7981 Cincado		Precios		Embalaje
d _s [mm]	L _s [mm]	Código	Precio €/100 u.	 (Uds)
2,2	5	2257981	2,20	5.000
	6,5	22657981	2,20	5.000
	8	2287981	2,20	5.000
	9,5	22957981	2,20	5.000
	16	22167981	2,40	5.000
2,9	5	2957981	1,90	5.000
	6,5	29657981	1,60	5.000
	8	2987981	1,50	5.000
	9,5	29957981	1,50	5.000
	13	29137981	1,70	5.000
	16	29167981	1,80	5.000
3,3	25	29257981	2,60	2.500
	6,5	33657981	1,90	5.000
	9,5	33957981	1,70	5.000
	13	33137981	1,80	5.000
	19	33197981	2,50	2.500
	22	33227981	2,80	2.500
3,5	9,5	35957981	1,60	5.000
	13	35137981	1,70	2.500
	16	35167981	2,10	2.500
	25	35257981	3,20	1.250
3,9	13	39137981	2,30	2.500
	13	48137981	3,50	1.250
4,8	16	48167981	3,80	1.250
	25	48257981	4,40	1.000

Tornillo DIN 7981F

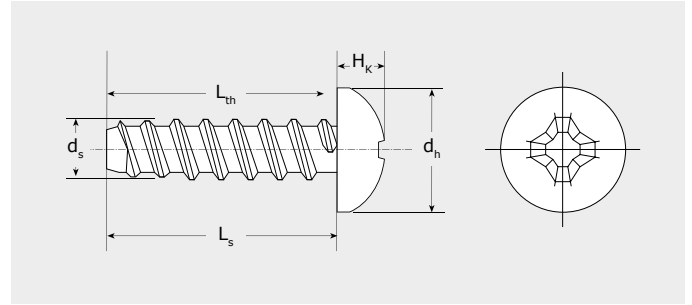

d_s : Diámetro tornillo L_{th} : Parte roscada. H_k : Altura de cabeza.
 L_s : Longitud tornillo. d_h : Diámetro cabeza.

Características

- Cabeza alomada.
- Impronta Philips (PH).
- Punta F.

Bolsas

DIN 7981F Cincado						Precios		Embalaje
d_s [mm]	L_s [mm]	L_{th} [mm]	d_h [mm]	H_k [mm]	Impronta	Código	Precio €/100 u.	 (Uds)
2,2	5	T	4,2	1,8	PH1	2257981F	3,60	5.000
	6,5					22657981F	3,60	5.000
	9,5					22957981F	3,60	5.000
2,9	6,5	T	5,6	2,2	PH1	29657981F	2,70	5.000
	8					2987981F	2,60	5.000
	9,5					29957981F	2,60	5.000
	13					29137981F	2,70	5.000
3,3	6,5	T	6,2	2,3	PH2	33657981F	3,50	5.000
3,5	6,5	T	6,9	2,6	PH2	35657981F	3,50	5.000
	9,5					35957981F	2,70	2.500
	13					35137981F	3,00	2.500
4,2	9,5	T	8,2	3,05	PH2	42957981F	4,20	2.500
	13					42137981F	4,10	2.500

T Rosca total

Tornillo TORX® 7049



Cincado



Características

- Cabeza alomada.
- Impronta TORX®.
- Punta forma C.

Cajas

TORX 7049 Cincado							Precios		Envase	Embalaje
d_s [mm]	L_s [mm]	L_{th} [mm]	d_h [mm]	H_k [mm]	Impronta	Código	Precio €/100 u.	Uds	Uds	
3,5	9,5	T	7	2,6	T15	935957049T	2,90	1.000	32.000	
	13					935137049T	3,20	500	16.000	
	25					935257049T*	5,90	250	8.000	
4,2	9,5	T	8	3,1	T20	942957049T	4,10	500	16.000	
	13					942137049T	4,30	500	16.000	
	32					942327049T*	8,10	250	4.000	
	50					942507049T*	16,60	250	2.000	
	90									
4,8	13	T	9,5	3,7	T25	948137049T	6,00	500	8.000	
	25					948257049T	7,70	250	4.000	
	32					948327049T	9,90	250	4.000	
	38					948387049T	11,30	250	2.000	
	45					948457049T	14,60	250	2.000	
	50					948507049T	17,40	250	2.000	
	60					948607049T	21,70	250	2.000	
5,5	25	T	11	4	T25	955257049T	10,70	250	4.000	
	32					955327049T*	14,00	250	4.000	
	60					955607049T*	28,30	100	800	
	70					955707049T*	32,40	100	800	



Cincado negro

TORX 7049 Cincado Negro							Precios		Envase	Embalaje
d_s [mm]	L_s [mm]	L_{th} [mm]	d_h [mm]	H_k [mm]	Impronta	Código	Precio €/100 u.	Uds	Uds	
5,5	25	T	11	4	T25	9N55257049T ¹	14,70	250	4.000	

- T Rosca total
¹ No cumple la normativa RoHS
 * Hasta fin de existencias.

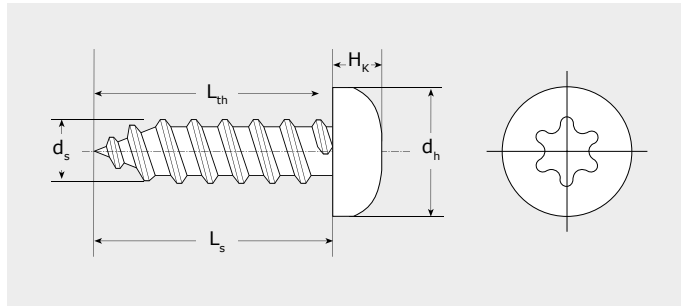

d_s : Diámetro tornillo L_{th} : Parte roscada. H_k : Altura de cabeza.
 L_s : Longitud tornillo. d_h : Diámetro cabeza.



Acero Inoxidable A2

TORX 7049 Acero Inoxidable A2							Precios		Envase	Embalaje
d_s [mm]	L_s [mm]	L_{th} [mm]	d_h [mm]	H_k [mm]	Impronta	Código	Precio €/100 u.	Uds	Uds	
3,5	16	T	7	2,6	T15	9X35167049T*	10,40	500	16.000	
4,8	19	T	9,5	3,7	T25	9X48197049T*	20,30	250	8.000	
	25					9X48257049T	23,70	250	4.000	
	38					9X48387049T	30,00	250	2.000	
	50					9X48507049T	39,20	250	2.000	
	60					9X48607049T	44,70	200	1.600	
5,5	50	T	11	4	T25	9X55507049T*	60,00	250	2.000	

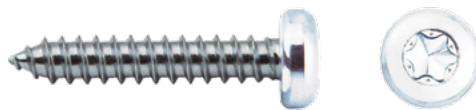

Lacado blanco

TORX 7049 Lacado Blanco							Precios		Envase	Embalaje
d_s [mm]	L_s [mm]	L_{th} [mm]	d_h [mm]	H_k [mm]	Impronta	Código	Precio €/100 u.	Uds	Uds	
4,8	38	T	9,5	3,7	T25	9W48387049T	27,60	250	2.000	

- T Rosca total
 * Hasta fin de existencias.

Tornillo DIN 7982



Cincado

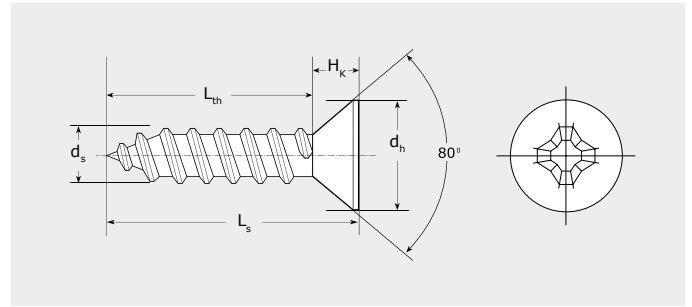

d_s : Diámetro tornillo L_{th} : Parte roscada. H_k : Altura de cabeza.
 L_s : Longitud tornillo. d_h : Diámetro cabeza.

Características

- Cabeza avellanada.
- Impronta Philips (PH).
- Punta forma C.

Cajas

DIN 7982 Cincado						Precios		Envase	Embalaje
d_s [mm]	L_s [mm]	L_{th} [mm]	d_h [mm]	H_k [mm]	Impronta	Código	Precio €/100 u.	(Uds)	(Uds)
2,9	6,5	T	5,5	1,7	PH1	929657982	1,80	1.000	32.000
	9,5					929957982	1,70	1.000	32.000
	13					929137982	1,90	1.000	32.000
3,5	9,5	T	6,8	2,1	PH2	935957982	1,90	1.000	32.000
	13					935137982	2,10	500	16.000
	16					935167982	2,50	500	16.000
	19					935197982	3,00	500	8.000
	22					935227982	3,60	500	8.000
	25					935257982	3,80	250	8.000
	32					935327982	4,40	250	8.000
	38					935387982	5,10	250	4.000
3,9	13	T	7,5	2,3	PH2	939137982	2,80	500	16.000
	16					939167982	3,00	500	16.000
	19					939197982	3,50	500	8.000
	22					939227982	3,80	250	8.000
	25					939257982	4,20	250	8.000
	32					939327982	4,90	250	4.000
4,2	13	T	8,1	2,5	PH2	939387982	5,50	250	4.000
	16					942137982	2,70	500	16.000
	19					942167982	3,20	500	8.000
	22					942197982	3,60	500	8.000
	25					942227982	4,10	250	8.000
	32					942257982	4,20	250	8.000
	38					942327982	5,50	250	4.000
4,8	13	T	9,5	3,0	PH2	942387982	6,40	250	4.000
	16					942457982	7,70	250	4.000
	19					942507982	9,40	250	2.000
	22					948167982	4,50	250	8.000
	25					948197982	5,10	250	8.000
	32					948227982	5,50	250	8.000
	38					948257982	5,20	250	4.000
	50					948327982	6,80	250	4.000
5,5	19	T	10,8	3,4	PH3	948387982	7,70	250	2.000
	25					948457982	10,00	250	2.000
	32					948507982	11,30	250	2.000
	38					948607982	14,00	250	2.000
	50					955197982	6,30	250	4.000
	50					955257982	7,00	250	4.000
	60					955327982	9,40	250	4.000
6,0	38		10,8	3,4	PH3	955387982	10,30	250	2.000
	50					955507982	13,00	250	2.000
	50					955607982	18,60	100	800
	60								

Bolsas

DIN 7982 Cincado		Precios		Embalaje
d_s [mm]	L_s [mm]	Código	Precio €/100 u.	(Uds)
2,2	6,5	22657982	2,70	5.000
	9,5	22957982	2,70	5.000
	13	22137982	2,80	5.000
2,9	9,5	29957982	1,70	5.000
	16	29167982	2,20	5.000
	19	29197982	2,50	2.500
3,3	13	33137982	2,20	5.000

Blister

DIN 7982 Cincado		Precios		Envase	Embalaje	Embalaje
d_s [mm]	L_s [mm]	Código	Precio €/Blister	(Uds)	(Blisters)	(Uds)
4,2	13	742137982	3,20	30	10	300
	16	742167982	3,20	25	10	250
	19	742197982	3,20	25	10	250
	25	742257982	3,20	20	10	200
	32	742327982	3,20	15	10	150
4,8	38	742387982	3,20	15	10	150
	19	748197982	3,20	20	10	200
	25	748257982	3,20	15	10	150



Cincado negro

Cajas

DIN 7982 Cincado Negro							Precios		Envase	Embalaje
d _s [mm]	L _s [mm]	L _{th} [mm]	d _h [mm]	H _k [mm]	Impronta	Código	Precio €/100 u.	(Uds)	(Uds)	
3,5	9,5	T	6,8	2,1	PH2	9N35957982 ¹	2,90	1.000	32.000	
3,9	9,5	T	7,5	2,3	PH2	9N39957982 ¹	4,00	500	16.000	
4,2	13	T	8,1	2,5	PH2	9N42137982 ¹	4,20	500	16.000	
	16					9N42167982 ¹	5,00	500	16.000	
	19					9N42197982 ¹	5,40	500	8.000	
	25					9N42257982 ¹	6,30	250	8.000	

T Rosca total

¹ No cumple la normativa Rohs



Lacado blanco

DIN 7982 Lacado Blanco							Precios		Envase	Embalaje
d _s [mm]	L _s [mm]	L _{th} [mm]	d _h [mm]	H _k [mm]	Impronta	Código	Precio €/100 u.	(Uds)	(Uds)	
4,2	19	T	8,1	2,5	PH2	9W42197982	9,70	500	8.000	

T Rosca total



Acero Inoxidable A2



DIN 7982 Acero Inoxidable A2							Precios		Envase	Embalaje
d _s [mm]	L _s [mm]	L _{th} [mm]	d _h [mm]	H _k [mm]	Impronta	Código	Precio €/100 u.	(Uds)	(Uds)	
3,5	13	T	6,8	2,1	PH2	9X35137982 ¹	7,70	500	16.000	
	19					9X35197982 ¹	8,60	500	8.000	
3,9	13	T	7,5	2,3	PH2	9X39137982 ¹	9,40	500	16.000	
	19					9X39197982 ¹	11,00	500	8.000	
4,2	13	T	8,1	2,5	PH2	9X42137982 ¹	10,70	500	16.000	
	16					9X42167982 ¹	11,40	500	8.000	
	19					9X42197982 ¹	12,50	500	8.000	
	25					9X42257982 ¹	15,40	250	8.000	
	32					9X42327982 ¹	17,20	250	4.000	
	38					9X42387982 ¹	20,00	250	4.000	
	50					9X42507982 ¹	24,50	250	2.000	
4,8	13	T	9,5	3,0	PH2	9X48137982 ¹	14,90	500	8.000	
	19					9X48197982 ¹	18,30	250	8.000	
	25					9X48257982 ¹	21,30	250	4.000	
	32					9X48327982 ¹	24,70	250	4.000	
	38					9X48387982 ¹	26,90	250	2.000	
	45					9X48457982 ¹	30,20	250	2.000	
5,5	13	T	10,8	3,4	PH3	9X55137982 ¹	21,30	250	8.000	
	25					9X55257982 ¹	28,50	250	4.000	

T Rosca total

¹ No cumple la normativa Rohs

Tornillo DIN 7982F



Características

- Cabeza avellanada.
- Impronta Philips (PH).
- Punta F con pivote (antes BZ).

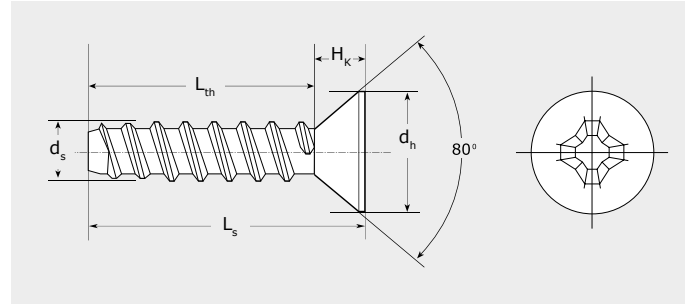

d_s : Diámetro tornillo L_{th} : Parte roscada. H_k : Altura de cabeza.
 L_s : Longitud tornillo. d_h : Diámetro cabeza.

Bolsas

DIN 7982 F Cincado						Precios		Embalaje
d_s [mm]	L_s [mm]	L_{th} [mm]	d_h [mm]	H_k [mm]	Impronta	Código	Precio €/100 u.	 (Uds)
2,9	13	T	5,5	17	PH1	29137982F	2,80	5.000

Tapón estrella zamak TZ

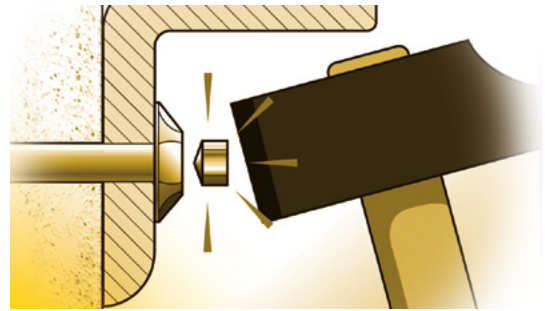



Características

- Los “tapones estrella” consiguen hacer indismontables tornillos con improntas TORX® y SIT®.

Cajas

Tapón TZ Cincado		Precios		Envase
Impronta	Código	Precio €/100 u.		 (Uds)
TORX / SIT 20	9TZ20	6,20		1.000
TORX / SIT 25	9TZ25	6,20		1.000
TORX / SIT 30	9TZ30	6,20		1.000

Tapón TZ Bicromatado		Precios		Envase
Impronta	Código	Precio €/100 u.		 (Uds)
TORX / SIT 20	9BTZ20	6,20		1.000
TORX / SIT 40	9BTZ40	8,00		1.000

Tapón TZ Negro		Precios		Envase
Impronta	Código	Precio €/100 u.		 (Uds)
TORX / SIT 20	9NTZ20	7,00		1.000

Tornillo DIN 7983



Cincado

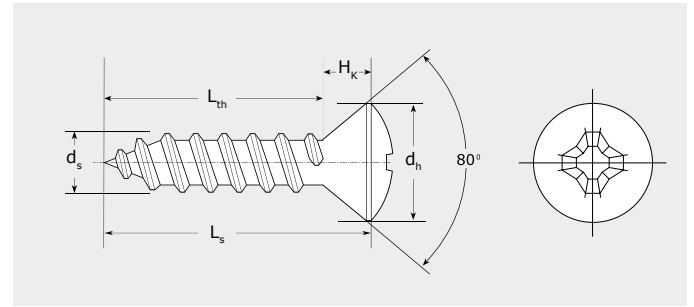

d_s : Diámetro tornillo L_{th} : Parte roscada. H_k : Altura de cabeza.
 L_s : Longitud tornillo. d_h : Diámetro cabeza.

Características

- Cabeza gota de sebo.
- Impronta Philips (PH).
- Punta forma C.

Cajas

DIN 7983 Cincado							Precios		Envase	Embalaje
d_s [mm]	L_s [mm]	L_{th} [mm]	d_h [mm]	H_k [mm]	Impronta	Código	Precio €/100 u.			
2,9	19	T	5,5	1,7	PH1	929197983*	3,20	1.000	16.000	
	25	929257983				4,30	500	8.000		
3,5	16	T	8	2,1	PH2	935167983	3,20	500	16.000	
	19	935197983				4,00	500	8.000		
	25	935257983				5,10	250	8.000		
3,9	16	T	7,5	2,3	PH2	939167983*	4,00	500	16.000	
	4,2	19				8,1	2,5	PH2	942197983	4,80
4,2	22					942227983*	5,40	250	8.000	
	32	942327983*				5,50	250	4.000		
	4,8	19				T	9,5	3,0	PH2	948197983*
4,8	38					948387983*	10,40	250	2.000	
	45	948457983*				13,40	250	2.000		
	50	948507983*				15,20	250	2.000		
	5,5	25				T	10,8	3,4	PH3	955257983*

T Rosca total
 * Hasta fin de existencias.



Cincado negro

DIN 7983 Cincado Negro							Precios		Envase	Embalaje
d_s [mm]	L_s [mm]	L_{th} [mm]	d_h [mm]	H_k [mm]	Impronta	Código	Precio €/100 u.			
2,9	9,5	T	5,5	1,7	PH1	9N29957983 ¹	3,60	1.000	32.000	
3,5	16	T	6,8	2,1	PH2	9N35167983 ¹	4,90	500	16.000	
	19	9N35197983 ¹				5,90	500	8.000		
	25	9N35257983 ¹				7,60	250	8.000		
3,9	22	T	7,5	2,3	PH2	9N39227983* ¹	7,70	250	8.000	
4,2	19	T	8,1	2,5	PH2	9N42197983 ¹	7,10	500	8.000	
	22					9N42227983* ¹	8,10	250	8.000	

T Rosca total
¹ No cumple la normativa Rohs
 * Hasta fin de existencias.

Bolsas

DIN 7983 Cincado		Precios		Embalaje
d_s [mm]	L_s [mm]	Código	Precio €/100	(Uds)
2,9	9,5	29957983	2,40	5.000
	13	29137983	2,70	5.000
	16	29167983	2,90	5.000
3,5	22	35227983*	4,60	2.500
	32	35327983*	5,90	1.250
4,8	16	48167983*	6,00	1.250

T Rosca total
 * Hasta fin de existencias.

Tornillo CH88H



Cincado

Características

- Cabeza alomada con arandela estampada.
- Impronta Philips (PH).
- Punta forma C.

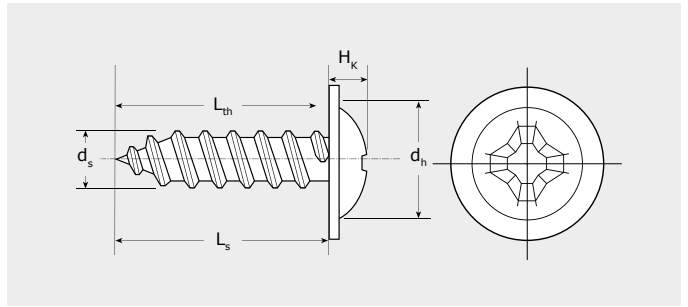

d_s : Diámetro tornillo L_{th} : Parte roscada. H_k : Altura de cabeza.
 L_s : Longitud tornillo. d_h : Diámetro cabeza.

Cajas

CH88H Cincado							Precios		Envase	Embalaje
d_s [mm]	L_s [mm]	L_{th} [mm]	d_h [mm]	H_k [mm]	Impronta	Código	Precio €/100 u.	(Uds)	(Uds)	
3,9	9,5	T	10,25	2,4	PH2	93995CH88H	3,80	500	8.000	
	13	93913CH88H				4,20	500	16.000		
	16	93916CH88H				4,60	500	8.000		
4,2	9,5	T	11,05	2,8	PH2	94295CH88H	4,80	250	4.000	
	13	94213CH88H				4,90	500	8.000		
	16	94216CH88H				5,10	500	8.000		
	19	94219CH88H				5,50	500	8.000		
	25	94225CH88H				6,70	500	8.000		
	32	94232CH88H				8,50	250	4.000		
4,8	13	T	11,75	3,10	PH2	94813CH88H	6,30	500	8.000	
	16	94816CH88H				6,80	250	4.000		
	19	94819CH88H				7,50	250	4.000		
	25	94825CH88H				8,70	250	4.000		
	32	94832CH88H				10,70	250	4.000		
	38	94838CH88H				11,70	250	2.000		

T Rosca total



Cincado negro

CH88H Cincado Negro							Precios		Envase	Embalaje
d_s [mm]	L_s [mm]	L_{th} [mm]	d_h [mm]	H_k [mm]	Impronta	Código	Precio €/100 u.	(Uds)	(Uds)	
3,9	9,5	T	10,2	2,2	PH2	9N3995CH88H ¹	5,50	500	16.000	
	13	9N3913CH88H ¹				6,00	500	8.000		
	16	9N3916CH88H ¹				6,80	500	8.000		
	19	9N3919CH88H ¹				6,80	500	8.000		
	25	9N3925CH88H ¹				9,00	250	4.000		
4,2	9,5	T	11	2,6	PH2	9N4295CH88H ¹	6,80	250	4.000	
	13	9N4213CH88H ¹				7,00	500	8.000		
	16	9N4216CH88H ¹				7,50	500	8.000		
	19	9N4219CH88H ¹				8,00	500	8.000		
	22	9N4222CH88H ¹				9,40	500	8.000		
	25	9N4225CH88H ¹				9,60	250	4.000		
4,8	13	T	11,7	2,9	PH2	9N4232CH88H ¹	12,20	250	4.000	
	16	9N4813CH88H ¹				9,00	500	8.000		
	19	9N4816CH88H ¹				9,80	250	4.000		
	19	9N4819CH88H ¹				10,90	250	4.000		
	22	9N4822CH88H ¹				11,60	250	4.000		
	25	9N4825CH88H ¹				12,60	250	4.000		
	32	9N4832CH88H ¹				15,40	250	4.000		
	38	9N4838CH88H ¹				16,80	250	2.000		

T Rosca total
¹ No cumple la normativa Rohs

Tornillo cabeza alomada

SIT 7049S



Cincado



Características

- Cabeza alomada.
- Imprinta SIT®. Permite un encaje perfecto para atornillar fácilmente.
- Punta forma C.

Cajas

SIT 7049 Cincado						Precios		Envase	Embalaje
d _s [mm]	L _s [mm]	L _{th} [mm]	d _h [mm]	H _k [mm]	Imprinta	Código	Precio €/100 u.	(Uds)	(Uds)
3,5	9,5	T	7	2,8	SIT 20	935957049S	3,30	1000	32000
	16					935167049S	4,00	500	16000
	19					935197049S	5,10	500	8000
	25					935257049S	6,30	250	8000
4,2	9,5	T	8	3,1	SIT 20	942957049S	4,40	500	16000
	19					942197049S	5,20	500	8000
	25					942257049S	6,40	250	8000
	32					942327049S	8,40	250	4000
	45					942457049S	11,30	250	2000
	50					942507049S	14,20	250	2000
	4,8	13	T	9,5	3,7	SIT 25	948137049S	6,20	500
	16					948167049S	6,90	250	8000
	25					948257049S	8,30	250	4000
	32					948327049S	10,90	250	4000
	38					948387049S	12,30	250	2000
	50					948507049S	16,00	250	2000
	60					948607049S	20,10	250	2000
	70					948707049S	26,20	100	800
	80					948807049S	30,70	100	800
	90					948907049S	37,80	100	800
	110					9481107049S	54,60	100	800
5,5	19	T	11	4	SIT 25	955197049S	9,90	250	2500
	25					955257049S	10,90	250	4000
	32					955327049S	12,10	250	2500
	45					955457049S	18,40	250	2000
	50					955507049S	20,80	250	2000
	60					955607049S	26,10	100	800
	70					955707049S	34,00	100	800
	80					955807049S	37,80	100	800
	90					955907049S	44,80	50	400
	100					9551007049S+	51,90	100	800

T Rosca total
* Hasta fin de existencias.

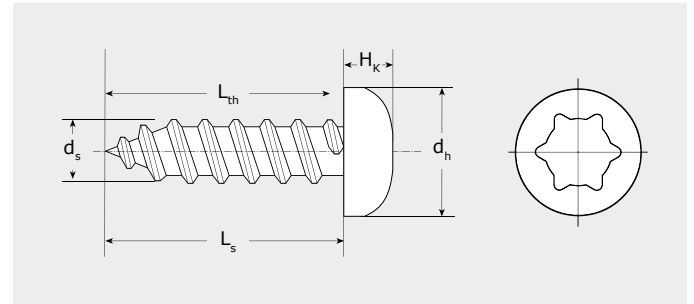

d_s: Diámetro tornillo L_{th}: Parte roscada. H_k: Altura de cabeza.
L_s: Longitud tornillo. d_h: Diámetro cabeza.



Cincado negro

SIT 7049 Cincado Negro						Precios		Envase	Embalaje
d _s [mm]	L _s [mm]	L _{th} [mm]	d _h [mm]	H _k [mm]	Imprinta	Código	Precio €/100 u.	(Uds)	(Uds)
4,2	13	T	8	3,1	SIT20	9N42137049S ¹	6,20	500	8.000
	19					9N42197049S ¹	7,40	500	8.000
	25					9N42257049S ¹	8,30	250	8.000
	32					9N42327049S ¹	11,40	250	4.000
4,8	32		9,5	3,7	SIT25	9N48327049S ¹	15,40	250	4.000
	38					9N48387049S ¹	17,40	250	2.000

T Rosca total
¹ No cumple la normativa Rohs



Acero Inoxidable A2

SIT 7049 Acero Inoxidable A2						Precios		Envase	Embalaje
d _s [mm]	L _s [mm]	L _{th} [mm]	d _h [mm]	H _k [mm]	Imprinta	Código	Precio €/100 u.	(Uds)	(Uds)
3,5	9,5	T	7	2,8	SIT 20	9X35957049S ¹	10,20	1.000	32.000
	13					9X35137049S ¹	10,20	500	16.000
	16					9X35167049S ¹	11,10	500	16.000
4,2	19	T	8	3,1	SIT 20	9X42197049S ¹	16,10	500	8.000
	25					9X42257049S ¹	19,90	250	8.000
	32					9X42327049S ¹	25,10	250	4.000
4,8	13	T	9,5	3,7	SIT 25	9X48137049S ¹	18,20	500	8.000
	19					9X48197049S ¹	22,50	500	8.000
	25					9X48257049S ¹	26,20	250	4.000
	32					9X48327049S ¹	30,40	250	4.000
	38					9X48387049S ¹	33,00	250	2.000
	50					9X48507049S ¹	43,20	250	2.000
	60					9X48607049S ¹	49,50	250	2.000
70					9X48707049S ¹	64,00	100	800	
5,5	50	T	11	4	SIT 25	9X55507049S ¹	57,40	250	2.000
	60					9X55607049S ¹	71,10	100	800

T Rosca total
¹ No cumple la normativa Rohs

Tornillo cabeza avellanada SIT 7061



Características

- Cabeza avellanada.
- Impronta SIT®. Permite un encaje perfecto para atornillar fácilmente.
- Punta forma C.

Cajas

SIT 7061 Cincado						Precios		Envase	Embalaje
d_s [mm]	L_s [mm]	L_{th} [mm]	d_h [mm]	H_k [mm]	Impronta	Código	Precio €/100 u.	(Uds)	(Uds)
4,2	13	T	8	3,6	SIT20	942137061S	5,60	500	16.000
	16					942167061S	5,70	500	5.000
4,8	25	T	9	3,9	SIT20	948257061S	9,50	250	4.000
	32					948327061S	11,60	250	4.000
	38					948387061S	13,00	250	2.000

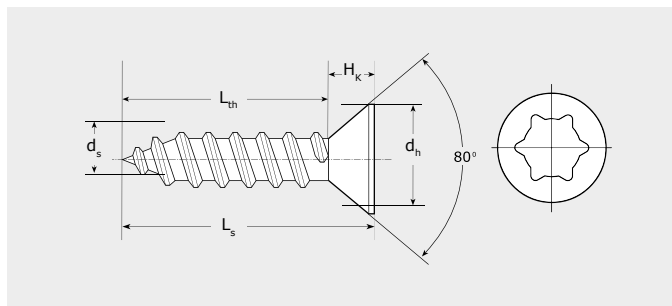

d_s : Diámetro tornillo L_{th} : Parte roscada. H_k : Altura de cabeza.
 L_s : Longitud tornillo. d_h : Diámetro cabeza.

Tornillo cabeza botón BTN



Características

- Cabeza botón.
- Impronta SIT®. Permite un encaje perfecto para atornillar fácilmente.
- Punta forma C.

Cajas

BTN Cincado						Precios		Envase	Embalaje
d_s [mm]	L_s [mm]	L_{th} [mm]	d_h [mm]	H_k [mm]	Impronta	Código	Precio €/100 u.	(Uds)	(Uds)
3,9	13	T	10	2,55	SIT20	93913BTN	5,20	500	8.000
	16					93916BTN	5,80	500	8.000
4,2	13	T	11	2,7	SIT20	94213BTN	5,80	500	8.000
	16					94216BTN	6,20	500	8.000
4,8	16	T	12	3,7	SIT20	94816BTN	8,20	250	4.000
	19					94819BTN	9,40	250	4.000

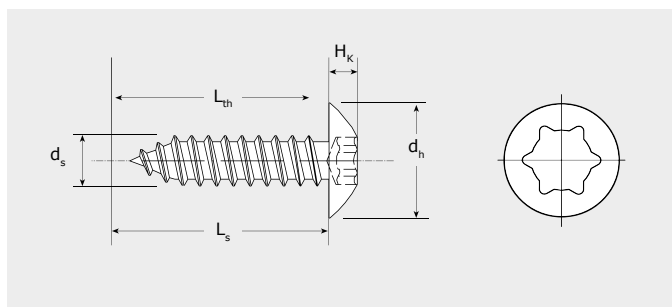

d_s : Diámetro tornillo L_{th} : Parte roscada. H_k : Altura de cabeza.
 L_s : Longitud tornillo. d_h : Diámetro cabeza.

Tornillo cabeza reducida FCE

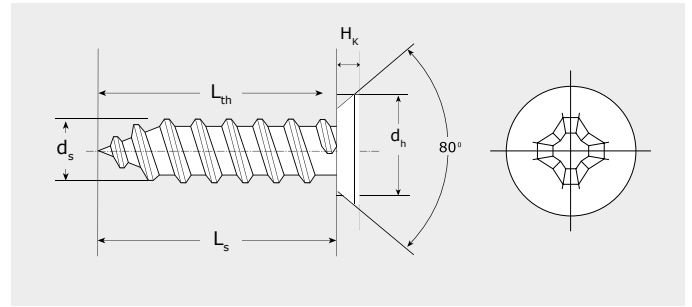

d_s : Diámetro tornillo
 L_s : Longitud tornillo.
 L_{th} : Parte roscada.
 d_h : Diámetro cabeza.
 H_k : Altura de cabeza.

Características

- Cabeza alomada reducida 6,8 [mm]
- Impronta Philips (PH2).
- Rosca filete de uso polivalente (madera/aluminio/taco).
- Para fijación de la corredera europea. Su cabeza reducida permite una fijación invisible y rápida sobre el marco.

Cajas

FCE Cincado						Precios		Envase	Embalaje
d_s [mm]	L_s [mm]	L_{th} [mm]	d_h [mm]	H_k [mm]	Impronta	Código	Precio €/100 u.	(Uds)	(Uds)
4,5	30	T	7	2,65	PH2	94530FCE	8,10	500	16.000
	55					94555FCE	16,70	250	8.000
	70					94570FCE	19,70	250	4.000

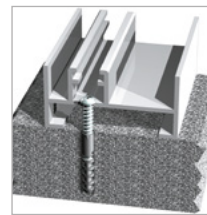

Taco en pared:

- Requiere taladro previo broca y taco $\varnothing 6$.
- Empotramiento mínimo: 35 [mm]

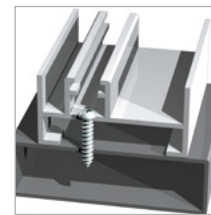

Premarco metálico:

- Requiere taladro previo: Sólo aluminio: 3/3,20 [mm]
- Empotramiento: mínimo: 8 [mm] máximo: s/grueso premarco.

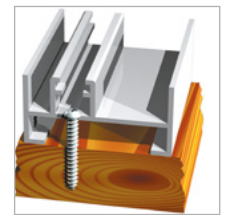

Premarco de madera:

- No requiere taladro previo.
- Empotramiento mínimo: 35 [mm]

Tornillo cabeza extraplana CE



Cincado

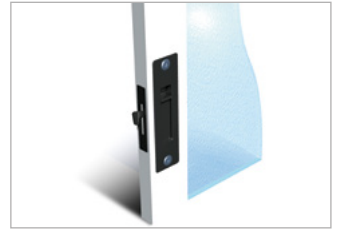

Características

- Cabeza extraplana con canto biselado, patentado.
- Impronta Philips (PH).
- Facilita el paso de la corredera.
- Recomendado para todas aquellas aplicaciones donde la altura de la cabeza deba ser mínima.

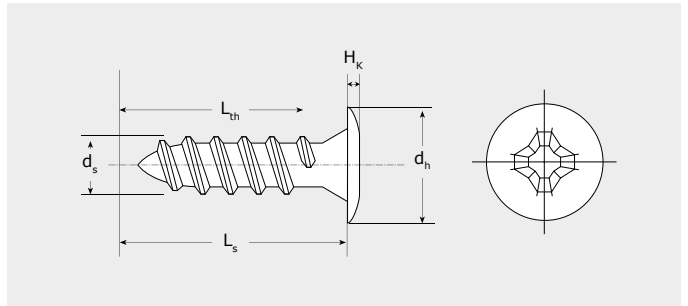

d_s : Diámetro tornillo L_{th} : Parte roscada. H_k : Altura de cabeza.
 L_s : Longitud tornillo. d_h : Diámetro cabeza.

Cajas

CE Cincado						Precios		Envase	Embalaje
d_s [mm]	L_s [mm]	L_{th} [mm]	d_h [mm]	H_k [mm]	Impronta	Código	Precio €/100 u.	(Uds)	(Uds)
4,2	13	T	8	0,7	PH2	94213CE	2,40	500	16.000
	22	94222CE				3,30	250	8.000	
	32	94232CE				4,50	250	4.000	

T Rosca total



Cincado negro



Acero Inoxidable A2

Cajas

CE Cincado negro						Precios		Envase	Embalaje
d_s [mm]	L_s [mm]	L_{th} [mm]	d_h [mm]	H_k [mm]	Impronta	Código	Precio €/100 u.	(Uds)	(Uds)
4,2	13	T	8	0,7	PH2	9N4213CE	3,40	500	16.000
	22	9N4222CE				4,80	250	8.000	
	32	9N4232CE				6,40	250	4.000	

T Rosca total

Cajas

CE Acero Inoxidable A2						Precios		Envase	Embalaje
d_s [mm]	L_s [mm]	L_{th} [mm]	d_h [mm]	H_k [mm]	Impronta	Código	Precio €/100 u.	(Uds)	(Uds)
4,2	13	T	8	0,7	PH2	9X4213CE	15,50	500	16.000
	22	9X4222CE				21,70	250	8.000	
	32	9X4232CE				26,50	250	4.000	

T Rosca total



Lacado blanco

Cajas

CE Lacado blanco						Precios		Envase	Embalaje
d_s [mm]	L_s [mm]	L_{th} [mm]	d_h [mm]	H_k [mm]	Impronta	Código	Precio €/100 u.	(Uds)	(Uds)
4,2	13	T	8	0,7	PH2	9W4213CE	7,40	500	16.000
	22	9W4222CE				8,80	250	8.000	
	32	9W4232CE				12,20	250	4.000	

T Rosca total

Tornillo cabeza extraplana FM

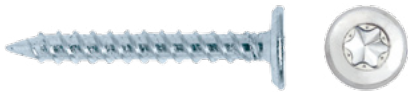

Cincado

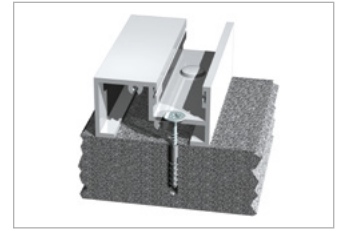

Características

- Cabeza extraplana.
- Impronta TORX®.
- Permite el clipaje de tapón EFM.
- Para fijación de marcos sobre todo tipo de materiales. Su cabeza extraplana asegura una gran superficie de sujeción sobre el marco.
- Se puede fijar con taco nylon FX6 o MZ6.
- Rosca doble hilo.

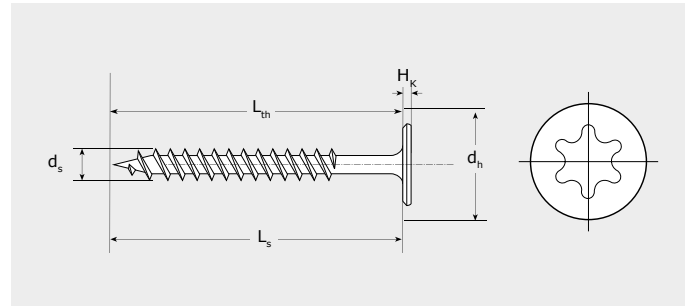

d_s : Diámetro tornillo L_{th} : Parte roscada. H_k : Altura de cabeza.
 L_s : Longitud tornillo. d_h : Diámetro cabeza.

Cajas

FM Cincado						Precios		Envase	Embalaje
d_s [mm]	L_s [mm]	L_{th} [mm]	d_h [mm]	H_k [mm]	Impronta	Código	Precio €/100 u.	(Uds)	(Uds)
4,5	25	T	11	1,8	TX20	94525FM	9,00	250	4.000
	35					94535FM	11,10	250	4.000
	45					94545FM	14,00	250	2.000
	55					94555FM	17,70	250	2.000
	65					94565FM	21,60	200	1600
	75					94575FM	24,00	100	800
	90					94590FM	31,50	100	800

T Rosca total

Tapón extraplano EFM



Características

- Tapón para Tornillo FM.

EFM	Precios		Envase	Embalaje
Color	Código	Precio €/100 u.	(Uds)	(Uds)
Blanco	91EFM	5,30	1.000	8.000
Negro	94EFM	5,30	1.000	8.000

Tornillo cabeza baja FS



Cincado

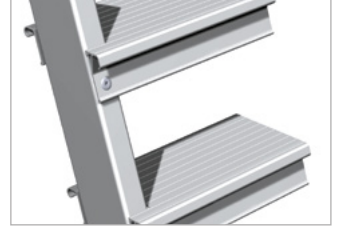

Características

- Philips (PH2).
- Rosca chapa.
- Punta forma C.
- La cabeza de altura reducida mejora la estética del ensamblaje. Evita la necesidad de avellanado de piezas donde la altura de la cabeza supone un problema.
- Mejor apoyo sobre una superficie plana al no disponer de cono debajo de la cabeza, roscado hasta la base.

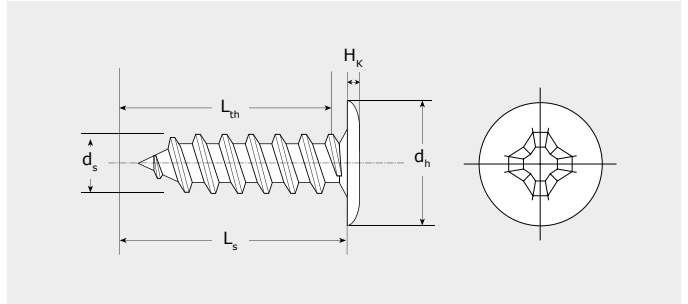

d_s : Diámetro tornillo L_{th} : Parte roscada. H_k : Altura de cabeza.
 L_s : Longitud tornillo. d_h : Diámetro cabeza.

Cajas

FS Cincado							Precios		Envase	Embalaje
d_s [mm]	L_s [mm]	L_{th} [mm]	d_h [mm]	H_k [mm]	Impronta	Código	Precio €/100 u.			
3,5	9,5	T	7	1,3	PH2	93595FS	3,30	1.000	32.000	
	13					93513FS	3,50	500	16.000	
	16					93516FS	4,00	500	16.000	
4,2	9,5	T	8,2	1,4	PH2	94295FS	4,10	500	16.000	
	13					94213FS	4,30	500	16.000	
	16					94216FS	5,00	500	8.000	
	19					94219FS	5,40	500	8.000	
4,8	13	T	9,5	1,6	PH2	94813FS	7,20	500	8.000	
	16					94816FS	7,10	250	8.000	
	19					94819FS	7,90	250	8.000	
	25					94825FS	8,60	250	4.000	

T Rosca total



Lacado blanco

Cajas

FS Lacado blanco							Precios		Envase	Embalaje
d_s [mm]	L_s [mm]	L_{th} [mm]	d_h [mm]	H_k [mm]	Impronta	Código	Precio €/100 u.			
3,5	9,5	T	7	1,3	PH2	9W3595FS	11,00	1.000	32.000	
	13					9W3513FS	11,30	500	16.000	

T Rosca total



Cincado negro

Cajas

FS Cincado negro							Precios		Envase	Embalaje
d_s [mm]	L_s [mm]	L_{th} [mm]	d_h [mm]	H_k [mm]	Impronta	Código	Precio €/100 u.			
3,5	9,5	T	7	1,3	PH2	9N3595FS ¹	4,70	1.000	32.000	
4,2	13		8,2	1,4	PH2	9N4213FS ¹	6,50	500	16.000	

¹ No cumple la normativa Rohs

T Rosca total

Tornillo para tapón NICE



Cincado

Características

- Cabeza avellanada.
- Impronta Pozi (PZ2).
- Con estrías, diseñadas para avellanar PVC.
- Diámetro cabeza Ø 4,5 (9 mm) Ø 5 (10 mm).

Cajas

NICE Cincado						Precios		Envase	Embalaje
d _s [mm]	L _s [mm]	L _{th} [mm]	d _h [mm]	H _k [mm]	Impronta	Código	Precio €/100 u.	(Uds)	(Uds)
4,5	30	19	9	3,1	PZ2	94530NICE	11,40	500	4.000
	40	24				94540NICE	12,80	500	4.000
	50	30				94550NICE	15,20	250	2.000
	60	35				94560NICE	17,30	250	2.000
5	40	24	10	3,45	PZ2	9540NICE	16,10	250	2.000
	50	30				9550NICE	18,30	250	2.000
	60	35				9560NICE	20,50	250	2.000
	70	40				9570NICE	25,20	200	1.600
	90	54				9590NICE	32,30	100	800

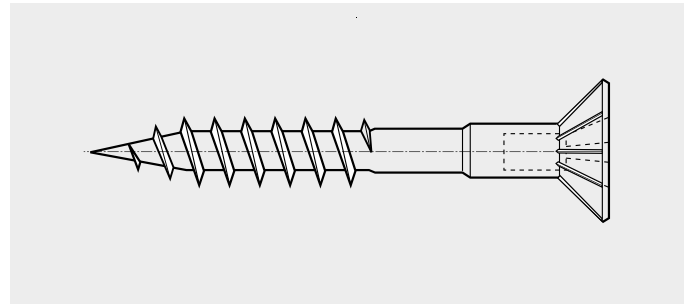
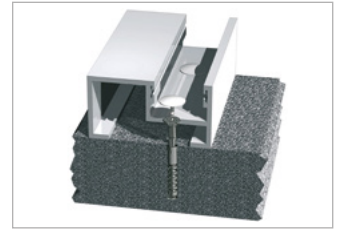
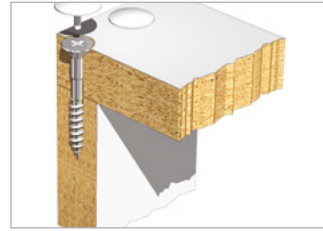

d_s: Diámetro tornillo L_{th}: Parte roscada H_k: Altura de cabeza.
L_s: Longitud tornillo. d_h: Diámetro cabeza.

Tapón pincho NICEN / NICEC / NICEB



NICEN - NICEC

NICEB

Características

- Tapón embellecedor de plástico para tornillo NICE.
- NICE-C: Especial compactos (persianas).
- NICE-N Ø13 / NICE-C Ø9 / NICE-B Ø13 [mm]
- NICE-B: Con corona que permite un perfecto asentamiento del tapón aunque la cabeza quede levantada.



NICE-B

Convencional

NICEN / NICEC / NICEB		Precios		Envase	Embalaje
Color	Tipo	Código	Precio €/100 u.	(Uds)	(Uds)
Blanco	NICEN	91NICEN	2,60	1.000	16.000
Negro		94NICEN	2,60	1.000	16.000
Gris		9GRNICEN	2,60	1.000	16.000
Marrón claro		9MNICEN	2,60	1.000	16.000
Marrón oscuro		9MONICEN	2,60	1.000	16.000
Blanco	NICEC	91NICEC	2,60	1.000	16.000
Blanco	NICEB	91NICEB	5,10	1.000	8.000
Negro		94NICEB	5,10	1.000	8.000

Tornillo cabeza envolvente CAHP

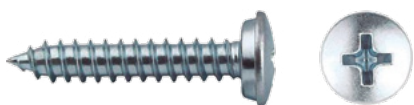

Cincado

Características

- Tornillo de cabeza envolvente para clipado de tapón de plástico. Ref. CAT o T12.
- En ensamblajes donde se requiera una mejora estética o bien una protección suplementaria a la corrosión.
- Impronta Philips (PH).
- Punta forma C.

Cajas

CAHP Cincado						Precios		Envase	Embalaje
d_s [mm]	L_s [mm]	L_{th} [mm]	d_h [mm]	H_k [mm]	Impronta	Código	Precio €/100 u.	(Uds)	(Uds)
4,2	19	T	10	3,35	PH2	94219CAHP	7,60	500	8.000
	25					94225CAHP	8,40	250	4.000
	32					94232CAHP	10,90	250	4.000
4,8	13	T	10	3,6	PH2	94813CAHP	6,30	500	8.000
	16					94816CAHP	7,20	250	8.000
	19					94819CAHP	7,60	250	8.000
	25					94825CAHP	9,20	250	4.000
	32					94832CAHP	10,90	250	4.000
	38					94838CAHP	12,00	250	2.000
	50					94850CAHP	19,00	250	2.000
	60					94860CAHP	23,10	250	2.000
	70					94870CAHP	26,80	100	800
	80	66				94880CAHP	31,20	100	800
	90					94890CAHP	38,90	100	800
100					948100CAHP	44,30	100	800	
5,5	16	T	10	3,6	PH3	95516CAHP	9,20	250	4.000
	19					95519CAHP	9,70	250	4.000
	25					95525CAHP	11,10	250	4.000
	32					95532CAHP	15,20	250	4.000
	38					95538CAHP	16,50	250	2.000
	50					95550CAHP	22,70	250	2.000
	60					95560CAHP	28,30	100	800
	70					95570CAHP	32,70	100	800
	80	66				95580CAHP	40,90	100	800
	90					95590CAHP	44,80	100	800
	100					955100CAHP	52,50	100	800

T Rosca total



CAHP Inox A2- Philips punta C

CAHP Acero Inoxidable A2						Precios		Envase	Embalaje
d_s [mm]	L_s [mm]	L_{th} [mm]	d_h [mm]	H_k [mm]	Impronta	Código	Precio €/100 u.	(Uds)	(Uds)
4,8	19	T	10	3,6	PH2	9X4819CAHP	27,90	250	8.000
	25					9X4825CAHP	32,60	250	4.000
	32					9X4832CAHP	34,90	250	4.000
	70					9X4870CAHP	88,30	100	800

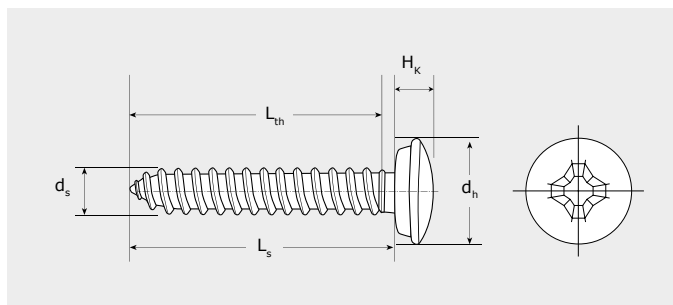
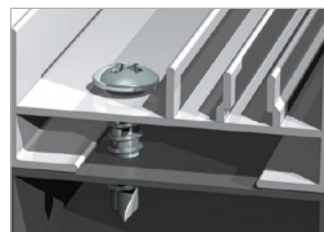

d_s : Diámetro tornillo L_{th} : Parte roscada. H_k : Altura de cabeza.
 L_s : Longitud tornillo. d_h : Diámetro cabeza.



TEC- Cincado- Philips Punta broca

TEC Cincado						Precios		Envase	Embalaje
d_s [mm]	L_s [mm]	L_{th} [mm]	d_h [mm]	H_k [mm]	Impronta	Código	Precio €/100 u.	(Uds)	(Uds)
4,8	25	25	10	3,6	PH2	94825TEC	10,80	250	4.000
	32	32				94832TEC	12,80	250	4.000
	38	38				94838TEC	14,50	250	2.000
	45	45				94845TEC	17,70	250	2.000
	50	50				94850TEC	20,10	250	2.000
	60	60				94860TEC	25,80	100	800

Tornillo panel sandwich PG

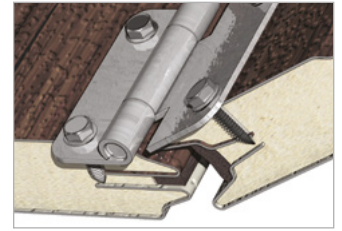

Características

- Cabeza hexagonal + arandela con estrías.
- Rosca Fastite®. Punta especial, no necesita taladro previo hasta 1 mm de espesor.
- Ensamblaje de bisagras y herrajes en puertas de garaje.
- Sobre panel sandwich.

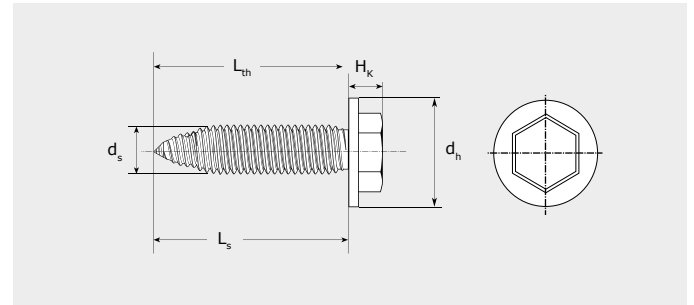

d_s : Diámetro tornillo L_{th} : Parte roscada. H_k : Altura de cabeza.
 L_s : Longitud tornillo. d_h : Diámetro cabeza.

Cajas

PG Cincado						Precios		Envase	Embalaje
d_s [mm]	L_s [mm]	L_{th} [mm]	d_h [mm]	H_k [mm]	Impronta	Código	Precio €/100 u.	(Uds)	(Uds)
6	25	T	13	5	SW10	9625PG	21,80	250	2.000

T Rosca total

Tapón embellecedor CAT / Tapón envolvente T12

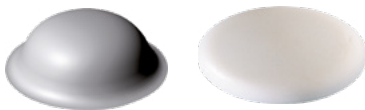

CAT

T12

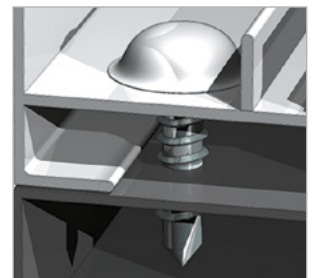

Características

- Tapón para tornillo envolvente.
- Para aplicar en tornillo ref.: CAHP, CAH, TEC, TECPLAS

Ventajas T12:

- Tapón para todos los tornillos envolventes. Su \varnothing exterior, menor que el CAT, permite la colocación del tapón en perfiles con poco espacio.

Ventajas CAT:

- Tapón para todos los tornillos envolventes. Su \varnothing exterior ancho permite tapar agujeros sobredimensionados.

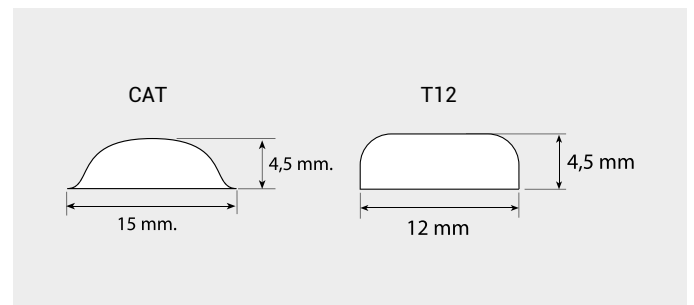

Cajas

CAT / T12		Precios		Envase	Embalaje
Color	Código	Precio €/100 u.	(Uds)	(Uds)	
Blanco	91CAT	4,50	1.000	8.000	
Negro	94CAT	4,50	1.000	8.000	
Gris	9GRCAT	4,50	1.000	8.000	
Blanco	91T12	5,20	1.000	8.000	
Negro	94T12	5,20	1.000	8.000	

Tornillo DIN 7981-0



Cincado

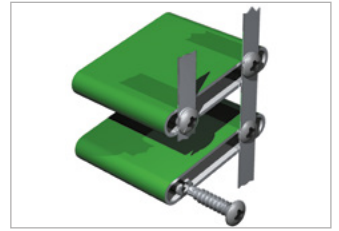

Características

- Punta guía.
- Para unión de perfiles de aluminio; la punta guía permite que el tornillo quede perfectamente guiado facilitando el atornillado desde el inicio.
- Especial para gusanillos extrusionados.
- Impronta Philips (PH).

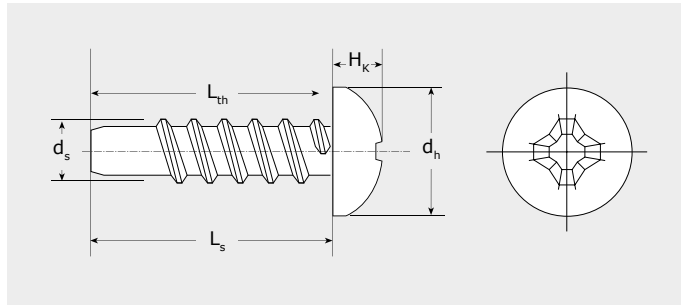

d_s : Diámetro tornillo L_{th} : Parte roscada. H_k : Altura de cabeza.
 L_s : Longitud tornillo. d_h : Diámetro cabeza.

Cajas

DIN 7981-0 Cincado						Precios		Envase	Embalaje
d_s [mm]	L_s [mm]	L_{th} [mm]	d_h [mm]	H_k [mm]	Impronta	Código	Precio €/100 u.	 (Uds)	 (Uds)
4,2	19	19	8,2	3,05	PH2	9421979810	5,10	500	8.000
	25	25				9422579810	6,20	250	8.000
4,8	25	25	9,5	3,55	PH2	9482579810	8,30	250	4.000
5,5	25	25	10,8	3,95	PH3	9552579810	11,00	250	4.000



Acero inoxidable A2.

DIN 7981-0 Acero Inoxidable A2						Precios		Envase	Embalaje
d_s [mm]	L_s [mm]	L_{th} [mm]	d_h [mm]	H_k [mm]	Impronta	Código	Precio €/100 u.	 (Uds)	 (Uds)
4,2	19	19	8,2	3,05	PH2	9X421979810	18,40	500	8.000
	25	25				9X422579810	20,20	250	8.000
4,8	19	19	9,5	3,55	PH2	9X481979810	22,10	250	8.000
	22	22				9X482279810	28,00	250	4.000

Tornillo junquillo ranura

CHJ / RJ / CHJH



CHJ RJ CHJH

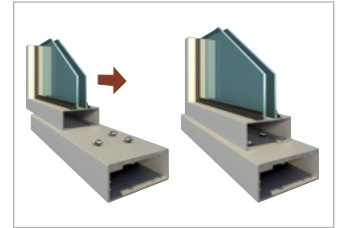

Características

- Junquillo rosca chapa (CHJ).
- Junquillo rosca rápida (RJ).
- Junquillo rosca chapa (PH2).

Cajas

CHJ / RJ / CHJH Cincado	Precios		Envase	Embalaje
	Código	Precio €/100 u.	(Uds)	(Uds)
CHJ	CHJ	5,60	1.000	16.000
RJ	RJ	4,50	1.000	16.000
CHJ-H	CHJH	5,80	1.000	16.000

Tornillo unión de montantes

PV70

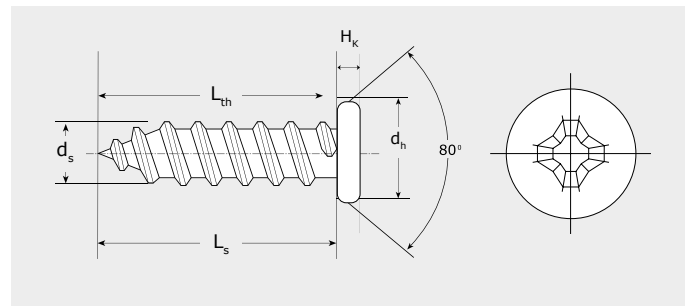

d_s : Diámetro tornillo L_{th} : Parte roscada. H_k : Altura de cabeza.
 L_s : Longitud tornillo. d_h : Diámetro cabeza.

Características

- Cabeza especial para tapón embellecedor.
- Impronta Philips (PH).
- Para la unión de montantes o para la fijación de marcos pvc a la pared.

Cajas

PV 70 Bicromatado						Precios		Envase	Embalaje
d_s [mm]	L_s [mm]	L_{th} [mm]	d_h [mm]	H_k [mm]	Impronta	Código	Precio €/100 u.	(Uds)	(Uds)
4,8	55	T	9,4	2,5	PH2	9B4855PV70	15,40	250	2.000
	65					9B4865PV70	18,50	250	2.000
	80					9B4880PV70	21,90	100	800
	95	P				9B4895PV70	31,10	100	800

T Rosca total
 P Rosca parcial

Tornillo broca cabeza extraplana CET



Cincado

Características

- Cabeza extraplana con canto biselado patentado.
- Impronta Philips (PH).
- El tornillo de acero tiene punta broca reducida.
- El tornillo de acero inoxidable tiene punta broca estándar para taladrar aluminio.
- Mismo diseño y mismas aplicaciones que la Ref. CE, pero con punta autotaladrante reducida, especial para taladrar chapas de aluminio (hasta 1,5 mm) y chapas finas de acero (de 0,7 hasta 1,5 mm).

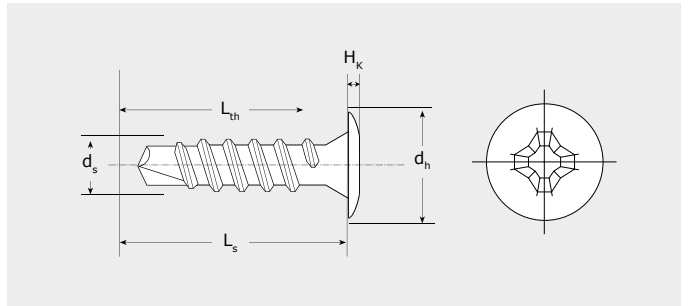
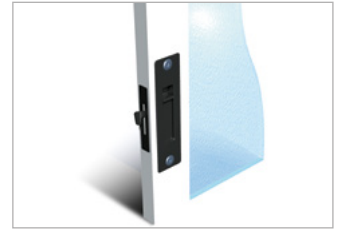

d_s : Diámetro tornillo L_{th} : Parte roscada. H_k : Altura de cabeza.
 L_s : Longitud tornillo. d_h : Diámetro cabeza.

Cajas

CET Cincado							Precios		Envase	Embalaje
d_s [mm]	L_s [mm]	L_{th} [mm]	d_h [mm]	H_k [mm]	Impronta	Código	Precio €/100 u.	(Uds)	(Uds)	
4,2	14 23	T	8	0,75	PH2	94214CET	3,50	500	16.000	
						94223CET	4,60	250	8.000	

T Rosca total



Cincado negro



Acero Inoxidable A2

Cajas

CET Cincado negro							Precios		Envase	Embalaje
d_s [mm]	L_s [mm]	L_{th} [mm]	d_h [mm]	H_k [mm]	Impronta	Código	Precio €/100 u.	(Uds)	(Uds)	
4,2	14 23	T	8	0,75	PH2	9N4214CET	4,80	500	16.000	
						9N4223CET	6,60	250	8.000	

T Rosca total



Lacado blanco

Cajas

CET Lacado blanco							Precios		Envase	Embalaje
d_s [mm]	L_s [mm]	L_{th} [mm]	d_h [mm]	H_k [mm]	Impronta	Código	Precio €/100 u.	(Uds)	(Uds)	
4,2	14 23	T	8	0,75	PH2	9W4214CET	9,10	500	16.000	
						9W4223CET	11,80	250	8.000	

T Rosca total

Cajas

CET Acero Inoxidable A2							Precios		Envase	Embalaje
d_s [mm]	L_s [mm]	L_{th} [mm]	d_h [mm]	H_k [mm]	Impronta	Código	Precio €/100 u.	(Uds)	(Uds)	
4,2	14	T	8	0,9	PH2	9X4214CET	25,90	500	16.000	

T Rosca total
 Taladra solo aluminio.

Tornillo broca cabeza ancha 75HA



Cincado

Características

- Útil en los casos en que se necesita repartir presiones o trabajar sobre agujeros sobredimensionados.
- Cabeza alomada con arandela estampada.
- Impronta Philips (PH).
- Punta broca (taladro hasta 3 [mm]).
- Para la fijación de metacrilato o tejido sobre chapa.

Cajas

75HA Cincado						Precios		Envase	Embalaje
d_s [mm]	L_s [mm]	L_{th} [mm]	d_h [mm]	H_k [mm]	Impronta	Código	Precio €/100 u.	(Uds)	(Uds)
4,2	13	T	11	2,6	PH2	9421375HA	5,50	500	8.000
	16					9421675HA	5,50	500	8.000
	19					9421975HA	6,20	250	8.000
	25					9422575HA	6,70	250	4.000
	32					9423275HA	7,90	250	4.000

T Rosca total



Cincado negro

75HA Cincado negro						Precios		Envase	Embalaje
d_s [mm]	L_s [mm]	L_{th} [mm]	d_h [mm]	H_k [mm]	Impronta	Código	Precio €/100 u.	(Uds)	(Uds)
4,2	13	T	11	2,6	PH2	9N421375HA	8,30	500	8.000
	16					9N421675HA	9,00	500	8.000
	19					9N421975HA	10,70	250	8.000
	25					9N422575HA	11,90	250	4.000

T Rosca total

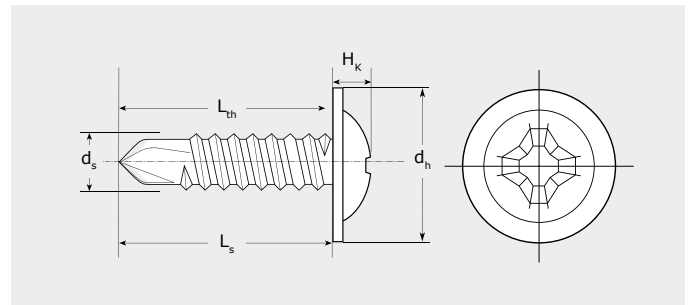
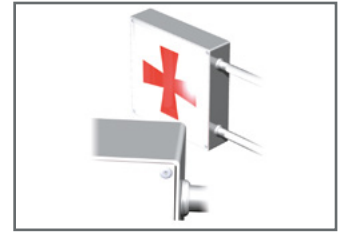
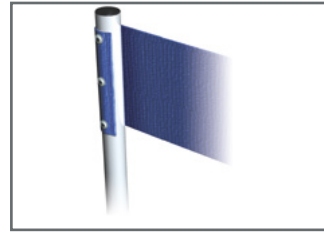

d_s : Diámetro tornillo L_{th} : Parte roscada. H_k : Altura de cabeza.
 L_s : Longitud tornillo. d_h : Diámetro cabeza.

Tornillo broca alomado

SIT® A85S



Cincado

Características

- Cabeza alomada.
- Impronta SIT®. Permite un encaje perfecto para atornillar fácilmente.
- Punta broca.
- Capacidad de taladros DIN 7504N.

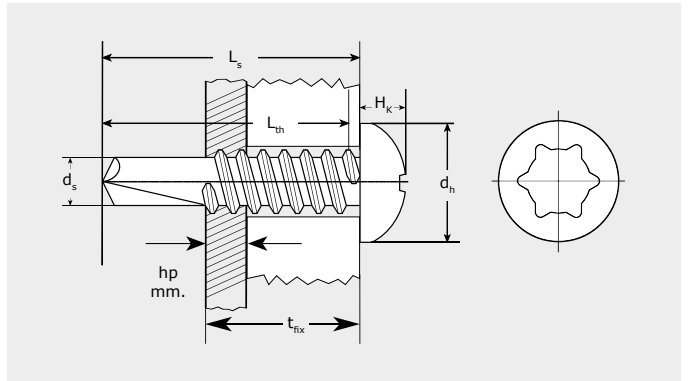

d_s : Diámetro tornillo
 L_s : Longitud tornillo.
 L_{th} : Parte roscada.
 d_h : Diámetro cabeza.

H_k : Altura de cabeza.
 t_{fix} : Espesor Max. a fijar
 H_p : Grosor de placa

Cajas

A85S Cincado									Precios		Envase	Embalaje
d_s [mm]	L_s [mm]	L_{th} [mm]	h_p [mm]	t_{fix} [mm]	d_h [mm]	H_k [mm]	Impronta	Código	Precio €/100 u.	 (Uds)	 (Uds)	
3,5	9,5	T	2	2,8	7	8	SIT20	93595A85S	3,10	1.000	32.000	
	13			6				93513A85S	3,50	500	16.000	
	16			9				93516A85S	4,00	500	16.000	
	19			12				93519A85S	4,40	500	8.000	
4,2	13	T	3	4	8	3,1	SIT20	94213A85S	4,60	500	16.000	
	16			7				94216A85S	4,90	500	8.000	
	19			10				94219A85S	5,70	500	8.000	
	25			16				94225A85S	7,00	250	8.000	
	32			23				94232A85S	8,30	250	4.000	
	38			29				94238A85S	9,50	250	4.000	
	50			41				94250A85S	11,80	250	2.000	
4,8	13	T	4	4	9,5	3,7	SIT25	94813A85S	6,40	250	8.000	
	16			5				94816A85S	7,00	250	8.000	
	19			8				94819A85S	7,80	250	8.000	
	25			14				94825A85S	9,50	250	4.000	
	32			21				94832A85S	11,10	250	4.000	
	38			27				94838A85S	12,20	500	4.000	
	45			34				94845A85S	12,80	250	2.000	
	50			39				94850A85S	13,60	250	2.000	
	63			52				94863A85S	16,20	200	2.000	
	75			64				94875A85S	22,60	100	800	
	90	P		79				94890A85S	34,40	100	800	
	100			89				948100A85S	39,00	100	800	
110			99				948110A85S	43,40	100	800		
120			109				948120A85S	51,20	100	800		
5,5	19	T	5	8	11	4	SIT25	95519A85S	10,40	250	4.000	
	25			14				95525A85S	11,30	250	4.000	
	32			21				95532A85S	12,80	250	4.000	
	38			27				95538A85S	15,00	250	2.000	
	50			39				95550A85S	25,30	250	2.000	
	63			52				95563A85S	29,80	100	800	
	75			64				95575A85S	34,40	100	800	



Acero Inoxidable A2

A85S Acero Inoxidable A2									Precios		Envase	Embalaje
d_s [mm]	L_s [mm]	L_{th} [mm]	h_p [mm]	T_{fix} [mm]	d_h [mm]	H_k [mm]	Impronta	Código	Precio €/100 u.	Envase (Uds)	Embalaje (Uds)	
3,5	9,5	T	2	2,8	7	8	SIT20	9X3595A85S	15,60	1.000	32.000	
	13			6				9X3513A85S	18,10	500	16.000	
	16			9				9X3516A85S	20,70	500	16.000	
4,2	13	T	3	4	8	3,1	SIT20	9X4213A85S	24,60	500	16.000	
	19			10				9X4219A85S	24,60	500	8.000	
4,8	19	T	4	8	9,5	3,7	SIT25	9X4819A85S	37,70	250	8.000	
	25			14				9X4825A85S	40,20	250	4.000	
	32			21				9X4832A85S	45,40	250	4.000	
	38			27				9X4838A85S	50,40	500	4.000	
	50			39				9X4850A85S	58,20	250	2.000	
	63			52				9X4863A85S	66,00	250	2.000	

Solo taladra aluminio.

Tornillo broca avellanado SIT® A61S

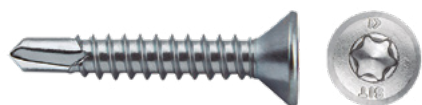

Cincado

Características

- Cabeza avellanada.
- Impronta SIT®. Permite un encaje perfecto para atornillar fácilmente.
- Punta broca.
- Capacidad de taladros DIN 7504P.

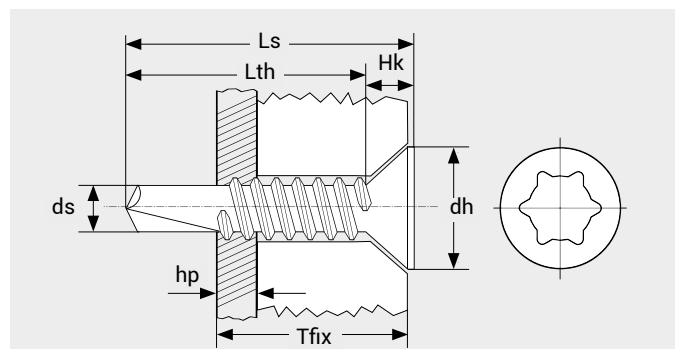

d_s : Diámetro tornillo L_{th} : Parte roscada. H_k : Altura de cabeza.
 L_s : Longitud tornillo. d_h : Diámetro cabeza.

Cajas

A61S Cincado									Precios		Envase	Embalaje
d_s [mm]	L_s [mm]	L_{th} [mm]	h_p [mm]	T_{fix} [mm]	d_h [mm]	H_k [mm]	Impronta	Código	Precio €/100 u.	Envase (Uds)	Embalaje (Uds)	
3,5	13	T	2	6	7,3	3,1	SIT10	93513A61S	4,30	500	16.000	
	16			9				93516A61S	4,40	500	16.000	
	19			12				93519A61S	4,60	500	16.000	
3,9	13	T	2	5	7,5	3,1	SIT20	93913A61S	4,90	500	16.000	
	16			8				93916A61S	5,30	500	16.000	
4,2	13	T	3	4	8,4	3,6	SIT20	94213A61S	4,90	500	16.000	
	16			7				94216A61S	5,30	500	8.000	
	19			10				94219A61S	6,40	500	8.000	
	25			16				94225A61S	7,30	250	8.000	
	32			23				94232A61S	8,30	250	4.000	
	4,8	19	T		8	9,3	3,9	SIT20	94819A61S	8,40	250	8.000
	25			19				94825A61S	10,70	250	4.000	
	32			21				94832A61S	11,40	250	4.000	
	38			27				94838A61S	14,10	500	4.000	
	50			39				94850A61S	15,00	250	2.000	

Tornillo DIN 7504N



Cincado

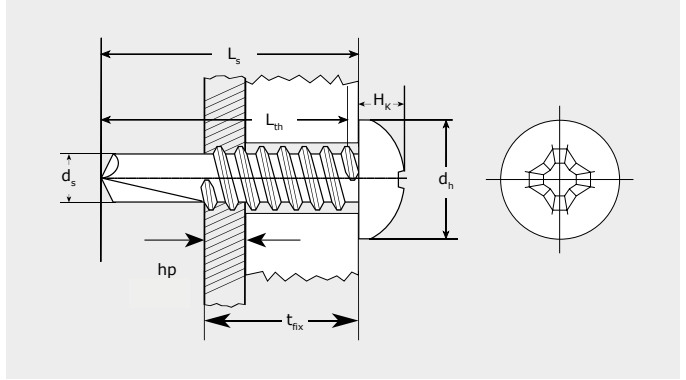

Características

- Cabeza alomada.
- Impronta Philips (PH).
- Punta broca.

d_s : Diámetro tornillo
 L_s : Longitud tornillo.
 L_{th} : Parte roscada.
 d_h : Diámetro cabeza.

H_k : Altura de cabeza.
 t_{fix} : Espesor Max. a fijar
 h_p : Grosor de placa

Cajas

DIN 7504N Cincado									Precios		Envase	Embalaje
d_s [mm]	L_s [mm]	L_{th} [mm]	hp< [mm]	t_{fix} < [mm]	d_h [mm]	H_k [mm]	Impronta	Código	Precio €/100 u.			
3,5	9,5	T	2	2,8	6,9	2,6	PH2	935957504N	1,60	1.000	32.000	
	11			4				935117504N	1,80	1.000	16.000	
	13			6				935137504N	1,90	500	16.000	
	16			9				935167504N	1,90	500	16.000	
	19			12				935197504N	2,20	500	8.000	
	22			15				935227504N	2,60	500	8.000	
	25			18				935257504N	2,70	250	8.000	
32			25				935327504N	3,20	250	8.000		
3,9	13	T	2	5	7,5	2,8	PH2	939137504N	2,30	500	16.000	
	16			8				939167504N	2,30	500	8.000	
	19			11				939197504N	2,80	500	8.000	
	25			17				939257504N	3,60	250	8.000	
	32			24				939327504N	3,90	250	4.000	
	4,2	13	T	3	4	8,2	3,05	PH2	942137504N	2,30	500	16.000
16			7				942167504N	2,60	500	8.000		
19			10				942197504N	2,70	500	8.000		
22			13				942227504N	3,20	250	8.000		
25			16				942257504N	3,60	250	8.000		
32			23				942327504N	4,40	250	4.000		
38			29				942387504N	4,60	250	4.000		
50			41				942507504N	6,00	250	2.000		
4,8	13	T	4	4	9,5	3,55	PH2	948137504N	3,20	500	8.000	
	16			5				948167504N	3,60	250	8.000	
	19			8				948197504N	3,90	250	8.000	
	22			11				948227504N	4,50	250	8.000	
	25			14				948257504N	4,80	250	4.000	
	32			21				948327504N	5,30	250	4.000	
	38			27				948387504N	6,30	500	4.000	
	45			34				948457504N	7,00	250	2.000	
	50			39				948507504N	8,00	250	2.000	
	63			52				948637504N	10,50	250	2.000	
	75			64				948757504N	12,60	100	800	
	90			79				948907504N	20,80	100	800	
	100	P		89				9481007504N	23,30	100	800	
	110			99				9481107504N	26,40	100	800	
120			109				9481207504N	31,10	100	800		
5,5	19	T	5	8	10,8	3,95	PH3	955197504N	5,70	250	4.000	
	25			14				955257504N	6,30	250	4.000	
	32			21				955327504N	7,20	250	4.000	
	38			27				955387504N	8,50	250	2.000	
	50			39				955507504N	14,90	250	2.000	
	63			52				955637504N	16,70	100	800	
	75			64				955757504N	20,40	100	800	

¹ No cumple la normativa Rohs
T Rosca total

Blister

DIN 7504N Cincado		Precios		Envase	Embalaje	Embalaje
d_s [mm]	L_s [mm]	Código	Precio €/Blister			
3,5	9,5	735957504N	3,20	40	10	400
	9,5	435957504N	6,30	200	10	2000
	13	735137504N	3,20	35	10	350
	13	435137504N	6,30	160	10	1600
	16	735167504N	3,20	30	10	300
	16	435167504N	6,30	150	10	1500
4,2	13	742137504N	3,20	20	10	200
	13	442137504N	6,30	120	10	1200
	16	742167504N	3,20	20	10	200
	16	442167504N	6,30	120	10	1200
	19	742197504N	3,20	15	10	150
	19	442197504N	6,30	110	10	1100
4,8	25	742257504N	3,20	10	10	100
	25	442257504N	6,30	95	10	950
	16	748167504N	3,20	25	10	250
	16	448167504N	6,30	90	10	900
	19	748197504N	3,20	20	10	200
	19	448197504N	6,30	85	10	850
5,5	25	748257504N	3,20	20	10	200
	25	448257504N	6,30	70	10	700
	32	748327504N	3,20	15	10	150
	32	448327504N	6,30	60	10	600
	38	748387504N	3,20	15	10	150
	38	448387504N	6,30	50	10	500
	45	748457504N	3,20	5	10	50
	45	448457504N	6,30	40	10	400
	50	748507504N	3,20	5	10	50
	50	448507504N	6,30	35	10	350
	63	748637504N	3,20	5	10	50
	63	448637504N	6,30	30	10	300



Cincado negro

DIN 7504N Cincado negro									Precios		Envase	Embalaje
d _s [mm]	L _s [mm]	L _{th} [mm]	hp< [mm]	t _{fix} < [mm]	d _h [mm]	H _k [mm]	Impronta	Código	Precio €/100 u.	(Uds)	(Uds)	
3,5	9,5	T	2	2,8	6,9	2,6	PH2	9N35957504N	2,40	1.000	32.000	
	13		2	6				9N35137504N	3,10	500	16.000	
	16		2	9				9N35167504N	3,10	500	16.000	
	19		2	12				9N35197504N	3,50	500	8.000	
3,9	16	T	2	8	7,5	2,8	PH2	9N39167504N	3,70	500	8.000	
	4,2	T	3	4	8,2	3,05	PH2	9N42137504N	3,70	500	16.000	
4,2	16		3	7				9N42167504N	4,00	500	8.000	
	19		3	10				9N42197504N	4,40	500	8.000	
	25		3	16				9N42257504N	5,20	250	8.000	
	32		3	23				9N42327504N	7,00	250	4.000	
	38		3	29				9N42387504N	7,30	250	4.000	
	4,8	16	T	4	5	9,5	3,55	PH2	9N48167504N	5,50	250	8.000
19			4	8				9N48197504N	6,20	250	8.000	
25			4	14				9N48257504N	7,50	250	4.000	
38			4	27				9N48387504N	9,40	500	4.000	
45			4	34				9N48457504N	10,80	250	2.000	
50			4	39				9N48507504N	12,10	250	2.000	

T Rosca total



Lacado blanco

DIN 7504N Lacado blanco									Precios		Envase	Embalaje
d _s [mm]	L _s [mm]	L _{th} [mm]	hp< [mm]	t _{fix} < [mm]	d _h [mm]	H _k [mm]	Impronta	Código	Precio €/100 u.	(Uds)	(Uds)	
3,5	9,5	T	2	2,8	6,9	2,6	PH2	9W35957504N	7,80	1.000	32.000	
	13			6				9W35137504N	7,80	500	16.000	
	16			7				9W42167504N	9,10	500	16.000	
4,2	13	T	3	4	8,2	3,05	PH2	9W42137504N	9,10	500	16.000	
	16			7				9W42167504N	9,30	500	8.000	
	19			10				9W42197504N	9,50	500	8.000	
4,8	25	T	4	14	9,5	3,55	PH2	9W48257504N	13,10	250	4.000	
	32			21				9W48327504N	13,70	250	4.000	
	38			27				9W48387504N	14,40	500	4.000	

T Rosca total



Acero Inoxidable A2

DIN 7504N Acero Inoxidable A2									Precios		Envase	Embalaje
d _s [mm]	L _s [mm]	L _{th} [mm]	hp< [mm]	t _{fix} < [mm]	d _h [mm]	H _k [mm]	Impronta	Código	Precio €/100 u.	(Uds)	(Uds)	
3,5	9,5	T	2	2,8	6,9	2,6	PH2	9X35957504N	10,90	1.000	32.000	
	16			9				9X35167504N	14,30	500	16.000	
	19			12				9X35197504N	15,60	500	8.000	
3,9	16	T	2	8	7,5	2,8	PH2	9X39167504N	15,30	500	8.000	
	19			11				9X39197504N	16,00	500	8.000	
4,2	19	T	3	10	8,2	3,05	PH2	9X42197504N	17,50	500	8.000	
	25			16				9X42257504N	20,90	250	8.000	
	4,8	T	4	5	9,5	3,55	PH2	9X48167504N	22,90	250	8.000	
4,8	25			14				9X48257504N	25,20	250	4.000	
	32			21				9X48327504N	35,30	250	4.000	
	38			27				9X48387504N	38,40	500	4.000	
	50			39				9X48507504N	45,70	250	2.000	
	60			52				9X48607504N	54,10	250	2.000	

T Rosca total



Lacado rojo burdeos

DIN 7504N Lacado rojo burdeos									Precios		Envase	Embalaje
d _s [mm]	L _s [mm]	L _{th} [mm]	hp< [mm]	t _{fix} < [mm]	d _h [mm]	H _k [mm]	Impronta	Código	Precio €/100 u.	(Uds)	(Uds)	
3,5	13	T	2	5	6,9	2,6	PH2	9BU35137504N*	7,80	500	16.000	

*Hasta fin de existencias.

T Rosca total







Pintado marfil blanco

DIN 7504N Pintado marfil blanco									Precios		Envase	Embalaje
d _s [mm]	L _s [mm]	L _{th} [mm]	hp< [mm]	t _{fix} < [mm]	d _h [mm]	H _k [mm]	Impronta	Código	Precio €/100 u.	(Uds)	(Uds)	
3,5	13	T	2	6	6,9	2,6	PH2	9M35137504N*	7,80	500	16.000	

*Hasta fin de existencias.

T Rosca total

Otros colores y dimensiones bajo demanda (min. 25.000 Uds.)

	Azul: Ral 5009		Rojo Coral: Ral 3003
	Rojo Teja: Ral 3011		Negro: Ral 9005
	Crema Bidasoa: Ral 1000		Cobre: Ral 8112

Tornillo broca reducida ALUN

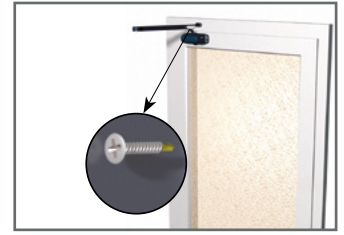

Características

- Cabeza alomada.
- Impronta Philips (PH).
- La punta broca reducida evita pasado de rosca en aluminio y chapas finas.

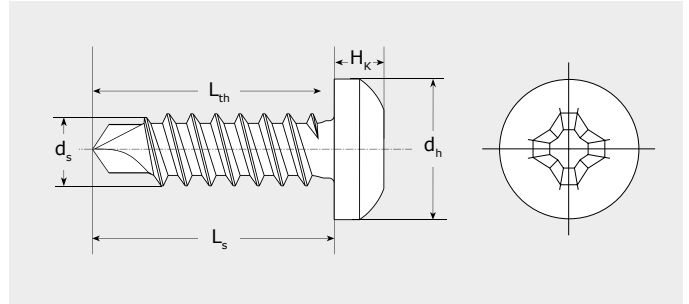

Cajas

d_s : Diámetro tornillo L_{th} : Parte roscada. H_k : Altura de cabeza.
 L_s : Longitud tornillo. d_h : Diámetro cabeza.

ALUN Cincado						Precios		Envase	Embalaje
d_s [mm]	L_s [mm]	L_{th} [mm]	d_h [mm]	H_k [mm]	Impronta	Código	Precio €/100 u.	 (Uds)	 (Uds)
3,9	13	T	7,5	2,8	PH2	93913ALUN	2,90	500	16.000
	16					93916ALUN	3,20	500	16.000
4,2	13	T	8,2	3,05	PH2	94213ALUN	2,80	500	16.000
	16					94216ALUN	3,20	500	8.000
	19					94219ALUN	3,60	500	8.000
	25					94225ALUN	5,00	250	8.000
	32					94232ALUN	5,80	250	4.000
4,8	25	T	9,5	3,55	PH2	94825ALUN	6,50	250	4.000
	38					94838ALUN	7,60	500	4.000
	50					94850ALUN	9,60	250	2.000
	63					94863ALUN	12,90	250	2.000
	75					94875ALUN	16,50	100	800
	90					94890ALUN	26,60	100	800
	100					948100ALUN	30,50	100	800

T Rosca total

Tapón embellecedor TN



Negro



Gris



Blanco

Características

- Compatible con cabeza DIN 7981, DIN7504N, A85S, 7049T.

Cajas

TN		Precios		Envase	Embalaje
Ø [mm]	Color	Código	Precio €/100 u.	 (Uds)	 (Uds)
4,2	Negro	94TN42	4,50	1.000	8.000
4,8	Negro	94TN	4,50	1.000	8.000
5,5	Negro	94TN55	4,50	1.000	8.000
4,8	Gris	9GRTN	4,50	1.000	8.000
4,2	Blanco	91TN42	4,50	1.000	8.000
4,8	Blanco	91TN	4,50	1.000	8.000
5,5	Blanco	91TN55	4,50	1.000	8.000

Tornillo DIN 7504P



Cincado

Características

- Cabeza avellanada.
- Impronta Philips (PH).
- Punta broca.

Cajas

DIN 7504P Cincado								Precios		Envase	Embalaje
d_s [mm]	L_s [mm]	L_{th} [mm]	hp< [mm]	t_{fix} < [mm]	d_h [mm]	H_k [mm]	Impronta	Código	Precio €/100 u.	(Uds)	(Uds)
3,5	13	T	2	6	6,8	2,1	PH2	935137504P	1,80	500	16.000
	16			9				935167504P	1,80	500	16.000
	19			12				935197504P	2,00	500	16.000
	25			18				935257504P	2,60	250	8.000
3,9	13	T	2	5	7,5	2,3	PH2	939137504P	2,20	500	16.000
	16			8				939167504P	2,50	500	16.000
	19			11				939197504P	2,90	500	8.000
	25			17				939257504P	3,40	250	8.000
	32			24				939327504P	3,70	250	8.000
	38			30				939387504P	3,90	250	4.000
4,2	13	T	3	4	8,1	2,5	PH2	942137504P	2,20	500	16.000
	16			7				942167504P	2,50	500	8.000
	19			10				942197504P	2,80	500	8.000
	25			16				942257504P	3,10	250	8.000
	32			23				942327504P	3,70	250	4.000
4,8	13	T	4	4	9,5	3	PH2	948137504P	3,10	500	8.000
	16			5				948167504P	3,40	250	8.000
	19			8				948197504P	3,70	250	8.000
	25			14				948257504P	4,70	250	4.000
	32			21				948327504P	5,20	250	4.000
	38			27				948387504P	6,20	500	4.000
	50			39				948507504P	7,30	250	2.000
5,5	32	T	5	21	10,8	3,4	PH3	955327504P	7,90	250	4.000
	38			27				955387504P	8,30	250	2.000
	50			39				955507504P	15,50	250	2.000



Cincado negro

DIN 7504P Cincado negro								Precios		Envase	Embalaje
d_s [mm]	L_s [mm]	L_{th} [mm]	hp< [mm]	t_{fix} < [mm]	d_h [mm]	H_k [mm]	Impronta	Código	Precio €/100 u.	(Uds)	(Uds)
3,5	13	T	2	6	6,8	2,1	PH2	9N35137504P	2,60	500	16.000
	16			9				9N35167504P	2,80	500	16.000
	19			12				9N35197504P	3,10	500	16.000
	25			18				9N35257504P	4,00	250	8.000
4,2	13	T	3	4	8,1	2,5	PH2	9N42137504P	3,40	500	16.000
	19			8				9N42197504P	4,30	500	8.000
	25			16				9N42257504P	4,80	250	8.000
	32			23				9N42327504P	5,70	250	4.000

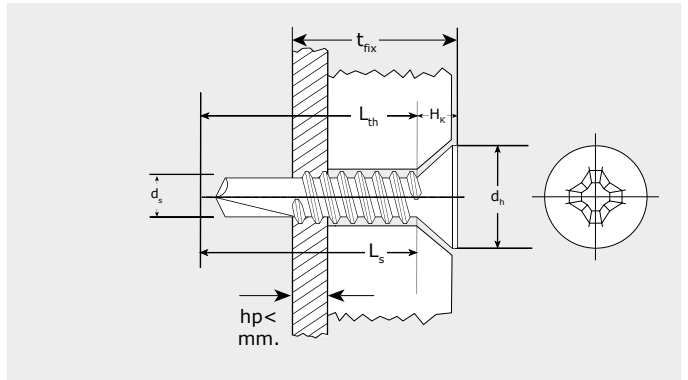

d_s : Diámetro tornillo
 L_s : Longitud tornillo.
 L_{th} : Parte roscada.
 d_n : Diámetro cabeza.

H_k : Altura de cabeza.
 t_{fix} : Espesor Max. a fijar
 Hp : Grosor de placa

Blister

DIN 7504P Cincado		Precios		Envase	Embalaje	Embalaje
d_s [mm]	L_s [mm]	Código	Precio €/Blister	(Uds)	(Blister)	(Uds)
3,5	13	735137504P	3,20	35	10	350
	16	735167504P	3,20	30	10	300



Acero inoxidable A2

DIN 7504P Acero inoxidable A2								Precios		Envase	Embalaje
d_s [mm]	L_s [mm]	L_{th} [mm]	hp< [mm]	t_{fix} < [mm]	d_h [mm]	H_k [mm]	Impronta	Código	Precio €/100 u.	(Uds)	(Uds)
3,5	16	T	2	8	6,9	2,6	PH2	9X35167504P	16,10	500	16.000

Tornillo DIN 7504K



Cincado

Características

- Cabeza hexagonal.
- Arandela estampada.
- Punta broca.

Cajas

DIN 7504K Cincado								Precios		Envase	Embalaje
d_s [mm]	L_s [mm]	L_{th} [mm]	$hp <$ [mm]	$t_{fix} <$ [mm]	d_h [mm]	H_k [mm]	Impronta	Código	Precio €/100 u.		
3,5	13	13	2	6	8,3	3,45	SW5,5	935137504K	2,50	500	16.000
	16	16		9				935167504K	2,70	500	8.000
	19	19		12				935197504K	3,00	500	8.000
4,2	13	13	3	4	8,8	4,25	SW7	942137504K	3,10	500	8.000
	16	16		7				942167504K	3,50	500	8.000
	19	19		10				942197504K	4,20	500	8.000
	25	25		16				942257504K	4,50	250	4.000
	13	13	4	4	9,8	4,45	SW8	948137504K	4,10	250	8.000
4,8	16	16		5				948167504K	4,30	250	8.000
	19	19		8				948197504K	4,40	1.000	4.000
	25	25		14				948257504K	5,50	250	4.000
	32	32		21				948327504K	6,20	250	4.000
	38	38		27				948387504K	7,30	250	2.000
	50	50		39				948507504K	9,00	250	2.000
	19	19	5	8	11	5,45	SW8	955197504K	5,10	500	4.000
	22	22		11				955227504K	5,80	500	4.000
	32	32		21				955327504K	8,50	500	4.000
6,3	38	38		27				955387504K	9,40	250	2.000
	45	45		34				955457504K	11,10	250	2.000
	50	50		39				955507504K	11,60	250	2.000
	63	63		52				955637504K	13,50	100	800
	19	19	5	7	13,2	6,45	SW10	963197504K	9,10	250	4.000
	25	25		13				963257504K	9,70	500	2.000
	32	32		20				963327504K	11,80	500	2.000
38	38	38		26				963387504K	12,80	500	2.000
	45	45		33				963457504K	15,60	100	800
	50	50		38				963507504K	16,20	200	800
	63	63		51				963637504K	19,20	100	800

DIN 7504K Láminas de zinc aluminio								Precios		Envase	Embalaje
d_s [mm]	L_s [mm]	L_{th} [mm]	$hp <$ [mm]	$t_{fix} <$ [mm]	d_h [mm]	H_k [mm]	Impronta	Código	Precio €/100 u.		
4,8	16	16	4	5	9,8	4,45	SW8	9ZG48167504K	6,20	1000	8000
	19	19		8				9ZG48197504K	6,40	1000	8000
5,5	22	22	5	11	11	5,45	SW8	9ZG55227504K	8,50	500	4000
	32	32		21				9ZG55327504K	12,50	500	2000
6,3	25	25	5	13	13,2	6,45	SW10	9ZG63257504K	14,40	500	2000
	32	32		20				9ZG63327504K	17,40	500	2000
	38	38		26				9ZG63387504K	19,20	500	2000
	50	50		38				9ZG63507504K	22,90	100	800

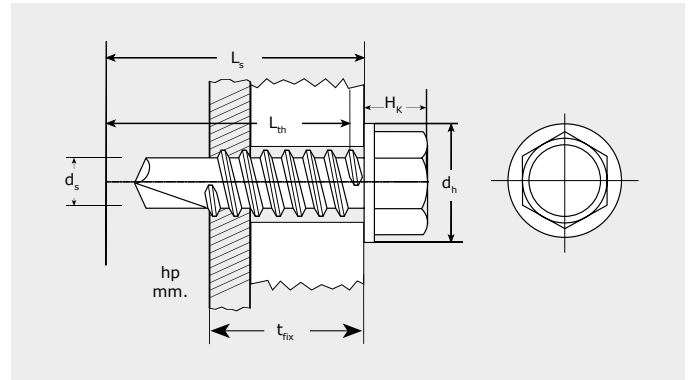

d_s : Diámetro tornillo
 L_s : Longitud tornillo.
 L_{th} : Parte roscada.
 d_h : Diámetro cabeza.

H_k : Altura de cabeza.
 t_{fix} : Espesor Max. a fijar
 Hp : Grosor de placa

Blister

DIN 7504K Cincado		Precios		Envase	Embalaje	Embalaje
d_s [mm]	L_s [mm]	Código	Precio €/Blister			
3,5	13	435137504K	6,30	130	10	1300
	16	435167504K	6,30	120	10	1200
4,2	13	442137504K	6,30	100	10	1000
	16	442167504K	6,30	100	10	1000
	19	442197504K	6,30	80	10	800
4,8	16	448167504K	6,30	75	10	750
	19	448197504K	6,30	70	10	700
	25	448257504K	6,30	55	10	550
6,3	25	463257504K	6,30	30	10	300
	32	463327504K	6,30	25	10	250

Tornillo 7301



Cincado

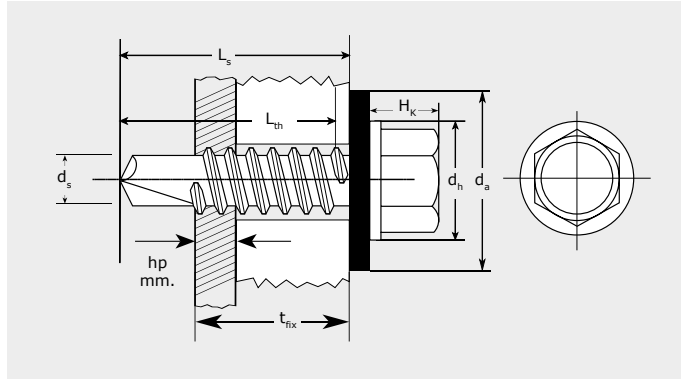

d_s : Diámetro tornillo
 L_s : Longitud tornillo
 L_{th} : Parte roscada
 d_h : Diámetro cabeza

H_k : Altura de cabeza
 t_{fix} : Espesor Max. a fijar
 h_p : Grosor de placa
 d_a : Diámetro exterior

Características

- Cabeza hexagonal.
- Arandela estanquidad.
- Punta broca.

Cajas

DIN 7301 Cincado										Precios		Envase	Embalaje
d_s [mm]	L_s [mm]	L_{th} [mm]	hp< [mm]	t_{fix} < [mm]	d_h [mm]	H_k [mm]	d_a [mm]	Impronta	Código	Precio €/100 u.	(Uds)	(Uds)	
4,8	16	T	3	2	9,8	4,45	14	SW8	948167301	8,50	1.000	4.000	
16			2	2			16		94816730116	8,80	1.000	4.000	
19				5			14		948197301	9,00	1.000	4.000	
19				5			16		94819730116	9,30	500	2.000	
25				11			14		948257301	10,30	800	200	
25				11			16		94825730116	10,70	500	2.000	
32				18			14		948327301	11,00	500	2.000	
38				24			14		948387301	12,10	500	2.000	
5,5	19	T	5	5	11	5,45	16	SW8	955197301	10,30	500	2.000	
22				8			16		955227301	11,20	1.000	4.000	
32				18			16		955327301	15,20	500	2.000	
38				24			16		955387301	16,40	500	2.000	
50				36			16		955507301	18,00	250	1.000	
63				49			16		955637301	19,90	500	800	
6,3	19	T	5	3,5	13,2	6,45	16	SW10	963197301	15,30	500	2.000	
25				9,5			16		963257301	15,90	500	2.000	
25				9,5			19		96325730119	17,70	250	2.000	
25				9,5			25		96325730125	21,70	250	2.000	
32				16,5			16		963327301	17,40	250	2.000	
38				22,5			16		963387301	20,00	100	800	
50				34,5			16		963507301	22,30	250	800	
63				47,5			16		963637301	25,10	250	1.000	

Tornillo broca TX inviolable

A85TI



Cincado

Características

- Cabeza alomada.
- Impronta TORX® inviolable.
- Punta broca.

Cajas

A85TI Cincado						Precios		Envase	Embalaje
d_s [mm]	L_s [mm]	L_{th} [mm]	d_h [mm]	H_k [mm]	Impronta	Código	Precio €/100 u.	(Uds)	(Uds)
3,9	13	T	7,5	2,8	T20	93913A85TI	7,80	500	16.000

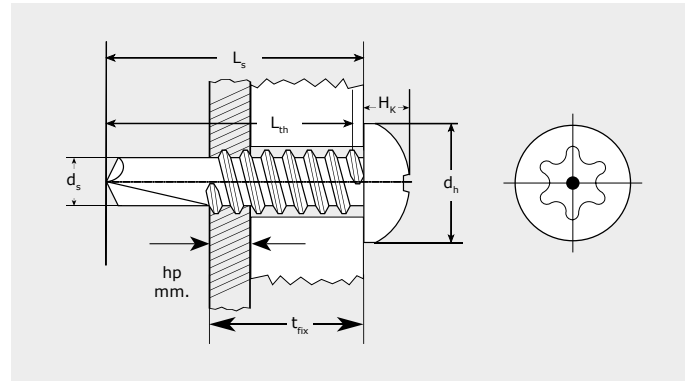

d_s : Diámetro tornillo
 L_s : Longitud tornillo.
 L_{th} : Parte roscada.
 d_h : Diámetro cabeza.

H_k : Altura de cabeza.
 t_{fix} : Espesor Max. a fijar
 H_p : Grosor de placa

Tornillo broca botón BTT



Cincado

Características

- Cabeza botón.
- Punta broca.
- Su cabeza ancha tapa agujeros sobredimensionados.
- Impronta SIT® "ajuste perfecto" para un fácil taladro.
- Parte NO roscada debajo de la cabeza para absorber la dilatación de la placa, diámetro 4,8 [mm]
- El recubrimiento ZINTEK® GRIS soporta seis veces más la resistencia a la corrosión que un tornillo cincado (480HNS).
- Capacidad de taladro como DIN 7504.

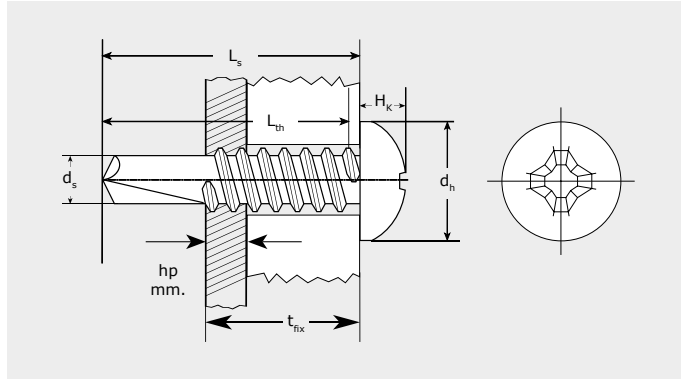

d_s : Diámetro tornillo
 L_s : Longitud tornillo.
 L_{th} : Parte roscada.
 d_h : Diámetro cabeza.

H_k : Altura de cabeza.
 t_{fix} : Espesor Max. a fijar
 h_p : Grosor de placa

Cajas

BTT Cincado									Precios		Envase	Embalaje
d_s [mm]	L_s [mm]	L_{th} [mm]	hp< [mm]	t_{fix} < [mm]	d_h [mm]	H_k [mm]	Impronta	Código	Precio €/100 u.			
4,2	13	T	2	4	11	2,7	S20	94213BTT	6,00	500	8.000	
	16			7				94216BTT	6,30	500	8.000	
	19			10				94219BTT	6,90	250	8.000	
	25			16				94225BTT	8,40	250	4.000	
	4,8	19	15	3	8	12		3,2	S20	94819BTT	9,80	500
	25	21		14				94825BTT	10,90	500	4.000	



Zintek Gris

BTT Zintek Gris									Precios		Envase	Embalaje
d_s [mm]	L_s [mm]	L_{th} [mm]	hp< [mm]	t_{fix} < [mm]	d_h [mm]	H_k [mm]	Impronta	Código	Precio €/100 u.			
4,8	19	15	3	8	12	3,2	S20	9K44819BTT	24,70	500	4.000	
	25	21		14				9K44825BTT	29,50	500	4.000	



Acero Inoxidable A2

BTT Acero inoxidable A2									Precios		Envase	Embalaje
d_s [mm]	L_s [mm]	L_{th} [mm]	hp< [mm]	t_{fix} < [mm]	d_h [mm]	H_k [mm]	Impronta	Código	Precio €/100 u.			
4,8	25	21	3	14	12	3,2	S20	9X4825BTT	76,70	500	4.000	

Solo taladra aluminio.

Tornillo broca cabeza baja FST



Cincado

Características

- Imprinta Philips (PH2).
- Rosca chapa hasta la base de la cabeza.
- La punta taladro de la Ref. FST según norma DIN 7504.
- Asienta perfectamente en la superficie al no tener cono debajo de la cabeza.

Cajas

FST Cincado								Precios		Envase	Embalaje
d_s [mm]	L_s [mm]	L_{th} [mm]	hp< [mm]	t_{fix} < [mm]	d_h [mm]	H_k [mm]	Imprinta	Código	Precio €/100 u.	Uds (Uds)	Uds (Uds)
3,5	9,5	T	2	4,5	7	1,3	PH2	93595FST	4,00	1.000	32.000
	13			8				93513FST	4,30	500	16.000
	16			11				93516FST	4,50	500	16.000
4,2	13	T	3	7	8,2	1,4	PH2	94213FST	5,80	500	16.000
	16			11				94216FST	5,90	500	8.000
	19			14				94219FST	6,70	500	8.000
	25			20				94225FST	8,70	250	8.000
	32			27				94232FST	9,10	250	4.000
4,8	13	T	4	5	9,5	1,6	PH2	94813FST	8,20	500	16.000
	16			8				94816FST	8,60	250	8.000
	19			11				94819FST	9,80	250	8.000
	25			17				94825FST	11,60	250	8.000
	32			24				94832FST	12,20	250	4.000
38			30				94838FST	14,00	250	4.000	

T Rosca total



Cincado negro.

FST Cincado negro								Precios		Envase	Embalaje
d_s [mm]	L_s [mm]	L_{th} [mm]	hp< [mm]	t_{fix} < [mm]	d_h [mm]	H_k [mm]	Imprinta	Código	Precio €/100 u.	Uds (Uds)	Uds (Uds)
3,5	9,5	T	2	4,5	7	1,3	PH2	9N3595FST	5,60	1.000	32.000
	13			8				9N3513FST	6,20	500	16.000
4,2	13	T	3	7	8,2	1,4	PH2	9N4213FST	8,30	500	16.000
	16			11				9N4216FST	8,70	500	8.000
	19			14				9N4219FST	9,80	500	8.000

T Rosca total

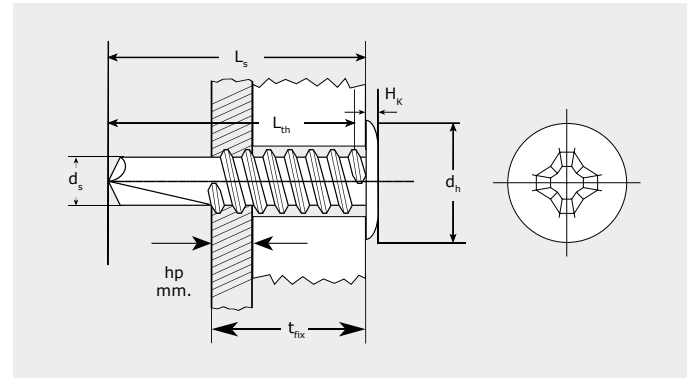

d_s : Diámetro tornillo
 L_s : Longitud tornillo.
 L_{th} : Parte roscada.
 d_h : Diámetro cabeza.

H_k : Altura de cabeza.
 t_{fix} : Espesor Max. a fijar
 h_p : Grosor de placa



Lacado blanco

FST Lacado blanco								Precios		Envase	Embalaje
d_s [mm]	L_s [mm]	L_{th} [mm]	hp< [mm]	t_{fix} < [mm]	d_h [mm]	H_k [mm]	Imprinta	Código	Precio €/100 u.	Uds (Uds)	Uds (Uds)
3,5	9,5	T	2	4,5	7	1,3	PH2	9W3595FST	11,20	1.000	32.000
	13			8				9W3513FST	11,40	500	16.000
4,2	13	T	3	7	8,2	1,4	PH2	9W4213FST	12,80	500	16.000

T Rosca total

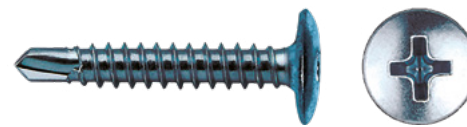

Acero Inoxidable A2

FST Acero inoxidable A2								Precios		Envase	Embalaje
d_s [mm]	L_s [mm]	L_{th} [mm]	hp< [mm]	t_{fix} < [mm]	d_h [mm]	H_k [mm]	Imprinta	Código	Precio €/100 u.	Uds (Uds)	Uds (Uds)
3,5	9,5	T	2	4,5	7	1,3	PH2	9X3595FST	17,70	1.000	32.000
4,2	13	T	3	7	8,2	1,4	PH2	9X4213FST	26,00	500	16.000
	16			11				9X4216FST	27,90	500	8.000
	19			14				9X4219FST	30,70	500	8.000
4,8	13	T	4	5	9,5	1,6	PH2	9X4813FST	29,70	500	16.000
	16			8				9X4816FST	35,30	250	8.000
	19			11				9X4819FST	37,10	250	8.000
	25			17				9X4825FST	42,70	250	8.000

T Rosca total
Solo taladra aluminio.

Tornillo broca reducida ALFST



Características

- Cabeza alomada.
- Impronta Philips (PH).
- La punta broca reducida evita pasado de rosca en aluminio y chapas finas.

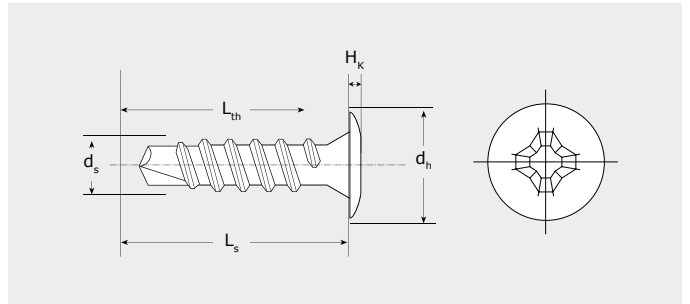

d_s : Diámetro tornillo L_{th} : Parte roscada. H_k : Altura de cabeza.
 L_s : Longitud tornillo. d_h : Diámetro cabeza.

Cajas

ALSFT Cincado						Precios		Envase	Embalaje
d_s [mm]	L_s [mm]	L_{th} [mm]	d_h [mm]	H_k [mm]	Impronta	Código	Precio €/100 u.	(Uds)	(Uds)
4,2	13	T	8,2	1,4	PH2	94213ALFST	6,50	500	16.000
	16	94216ALFST				6,80	500	16.000	
	19	94219ALFST				7,80	500	8.000	
	25	94225ALFST				9,40	250	8.000	

T Rosca total

Tornillo broca paso fino HM



Cincado

Características

- Cabeza gota sebo 120°.
- Impronta Philips (PH2).
- Punta broca.
- Diseñado especialmente para la fijación de herrajes metálicos sobre puertas y ventanas de carpintería metálica cuando el grueso del herraje y la chapa es de poco espesor.
- Cabeza avellanada gota sebo de 120° que permite que la rosca llegue más arriba evitando que el tornillo se pase de rosca.
- Para la fijación de cerraduras y contrcierres a puertas metálicas.
- Diámetro cabeza 7,5 [mm]

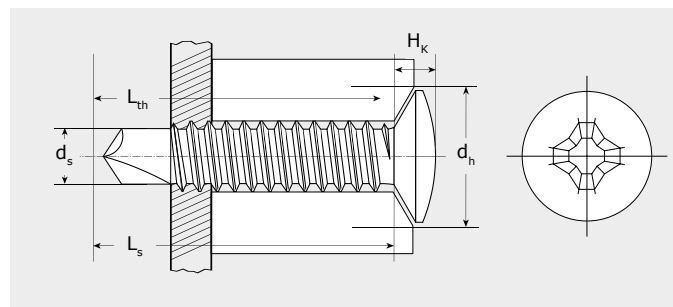
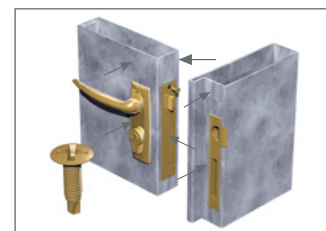

d_s : Diámetro tornillo L_{th} : Parte roscada. H_k : Altura de cabeza.
 L_s : Longitud tornillo. d_h : Diámetro cabeza.

Cajas

HM Cincado							Precios		Envase	Embalaje
d_s [mm]	L_s [mm]	L_{th} [mm]	d_h [mm]	H_k [mm]	Impronta	Código	Precio €/100 u.			
4	10	T	7,5	2	PH2	9410HM	4,10	500	16.000	
	13	9413HM				4,10	500	16.000		
	16	9416HM				4,80	500	16.000		
	19	9419HM				5,30	500	8.000		
	25	9425HM				5,80	500	8.000		



Cincado negro

HM Cincado negro							Precios		Envase	Embalaje
d_s [mm]	L_s [mm]	L_{th} [mm]	d_h [mm]	H_k [mm]	Impronta	Código	Precio €/100 u.			
4	16	T	7,5	2	PH2	9N416HM	6,70	500	16.000	
	19	9N419HM				7,60	500	8.000		
	25	9N425HM				8,40	500	8.000		

T Rosca total



Latonado

HM Latonado							Precios		Envase	Embalaje
d_s [mm]	L_s [mm]	L_{th} [mm]	d_h [mm]	H_k [mm]	Impronta	Código	Precio €/100 u.			
4	16	T	7,5	2	PH2	9L416HM	6,70	500	16.000	
	19	9L419HM				7,60	500	8.000		

T Rosca total

Tornillo broca reducida ALUH



Cincado

Características

- Cabeza gota sebo 120°.
- Impronta Philips (PH).
- Punta broca reducida. Evita pasado de rosca en aluminio y chapas finas.

Cajas

ALUH Cincado								Precios		Envase	Embalaje
d_s [mm]	L_s [mm]	L_{th} [mm]	h_p [mm]	$T_{fij.}$ [mm]	d_h [mm]	H_k [mm]	Impronta	Código	Precio €/100 u.	(Uds)	(Uds)
M4	13	T	2	8	7,5	2	PH2	94213ALUH	4,90	500	16.000
	16			11				94216ALUH	5,50	500	16.000
	19			14				94219ALUH	6,20	500	8.000

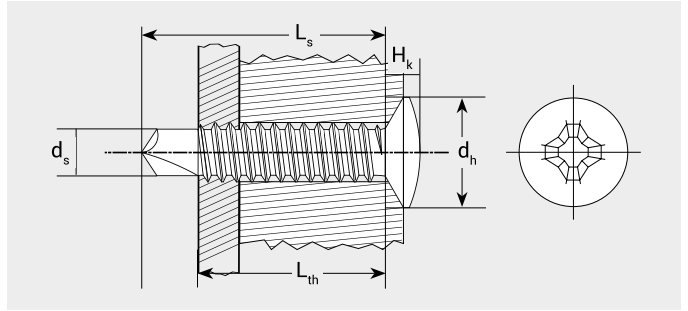

d_s : Diámetro tornillo
 L_s : Longitud tornillo.
 L_{th} : Parte roscada.
 d_h : Diámetro cabeza.

H_k : Altura de cabeza.
 $t_{fij.}$: Espesor máximo a fijar.
 h_p : Grosor de placa.

Tornillo matrícula TECPLAS



Características

- Tornillo envoltente (misma cabeza que CAHP).
- Rosca plástico 40°.
- Impronta Philips (PH2).
- Punta broca.
- Fijación de matrículas a soportes plásticos (parachoques).
- Mayor resistencia a la extracción al tener rosca especial para plásticos.

Cajas

TECPLAS Cincado						Precios		Envase	Embalaje
d_s [mm]	L_s [mm]	L_{th} [mm]	d_h [mm]	H_k [mm]	Impronta	Código	Precio €/100 u.	(Uds)	(Uds)
5,1	19	T	9	3,5	PH2	95119TECPLAS	10,80	250	4.000

T Rosca total

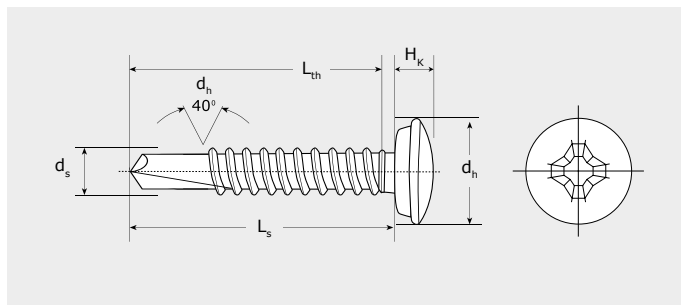

d_s : Diámetro tornillo
 L_s : Longitud tornillo.
 L_{th} : Parte roscada.
 d_h : Diámetro cabeza.

H_k : Altura de cabeza.

Punta broca p/montantes PV72



Características

- Cabeza especial para tapón embellecedor.
- Tornillo punta broca para la fijación directa.
- Taladra hasta 4 mm de espesor.



PV72				Precios		Envase	Embalaje
d _s [mm]	L _s [mm]	L _{th} [mm]	Impronta	Código	Precio €/100 u.	(Uds)	(Uds)
4,8	70	70	PH2	94870PV72	18,30	250	2.000
	80	80		94880PV72	20,80	100	800
	90	90		94890PV72	29,90	100	800

Tapón unión de montantes PV71



Características

- Tapón embellecedor de plástico para aplicar a la referencia PV-70 y PV-72, Ø 11 mm

PV71		Precios		Envase	Embalaje
Color	Código	Precio €/100 u.	(Uds)	(Uds)	
Negro	94PV71	4,40	1.000	8.000	
Blanco	91PV71	4,40	1.000	8.000	

Tornillo para perfil de PVC RH / KO / VK / TY

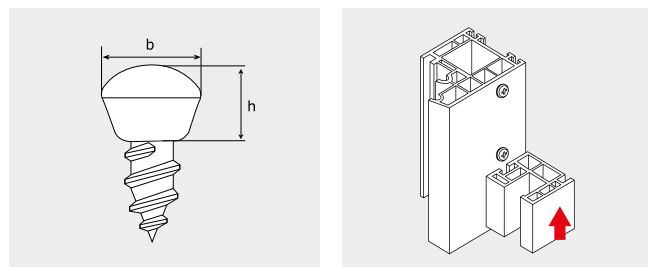
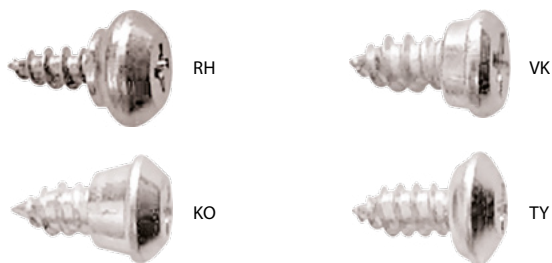

Características

- Cabeza especial.
- Philips (PH2).
- Fijación de vierteaguas.

RH / VK / KO / TY Cincado				Precios		Envase	Embalaje
d _s [mm]	L _s [mm]	L _{th} [mm]	Impronta	Código	Precio €/100 u.	(Uds)	(Uds)
5,5	12	T	PH2	95512RH	18,10	250	8.000
4,8	9,5			94895VK	18,70	500	8.000
5,5	10			95510KO	25,40	250	8.000
5,5	12			95512TY	24,10	250	8.000

RH / VK / KO Bicromatado				Precios		Envase	Embalaje
d _s [mm]	L _s [mm]	L _{th} [mm]	Impronta	Código	Precio €/100 u.	(Uds)	(Uds)
4,2	10	T	PH2	9B4210RH	19,90	250	8.000
4,2	10	T		9B4210VK	19,90	500	8.000
4,2	10	T		9B4210KO	26,70	250	8.000

Tornillo para PVC, rosca chapa punta broca PVS



(1) CON ESTRÍAS

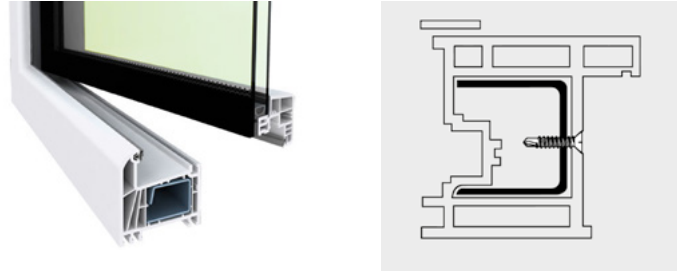

Características

- Cabeza avellanada.
- Impronta philips (PH).
- Punta broca.

PVS									Precios		Envase	Embalaje
d_s [mm]	L_s [mm]	L_{th} [mm]	$hp <$ [mm]	$t_{fix} <$ [mm]	d_h [mm]	H_k [mm]	Impronta	Código	Precio €/100 u.	(Uds)	(Uds)	
3,9	16(1)	12	2	10	7,5	2,6	PH2	93916PVS	3,80	1000	16000	
	19(1)	15		13				93919PVS	4,10	1000	16000	
	25	21		19				93925PVS	5,80	500	8000	
	32	28		26				93932PVS	6,90	500	8000	
	38	34		32				93938PVS	8,00	500	4000	

(1) CON ESTRÍAS

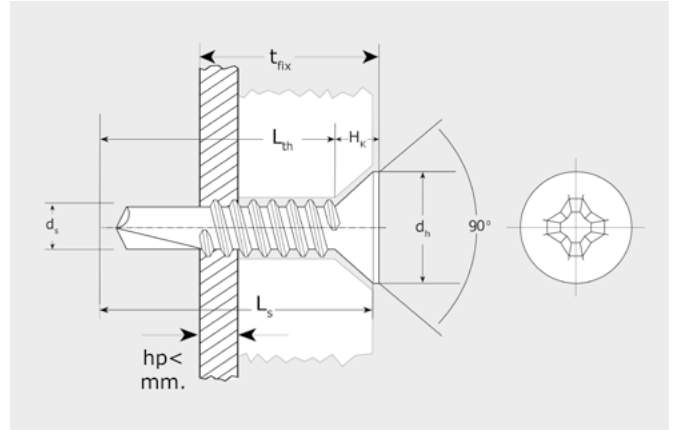

Tornillo para PVC, rosca métrica punta broca PVM



Características

- Cabeza avellanada.
- Impronta philips (PH).
- Punta broca.

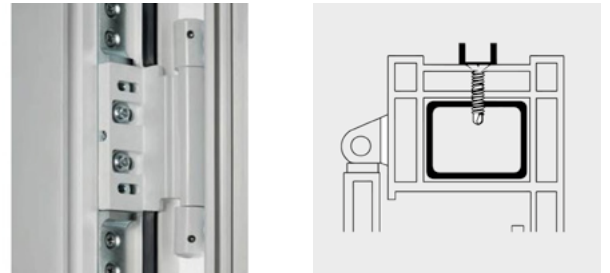

PVM									Precios		Envase	Embalaje
d_s [mm]	L_s [mm]	L_{th} [mm]	$h_p <$ [mm]	$t_{fix} <$ [mm]	d_h [mm]	H_k [mm]	Impronta	Código	Precio €/100 u.	(Uds)	(Uds)	
4	13	9	2	7	7,5	2,8	PH2	9413PVM	3,20	500	16000	
	16	12		10				9416PVM	3,60	1000	16000	
	19	15		13				9419PVM	4,00	1000	16000	
	25	21		19				9425PVM	4,90	500	8000	
	32	28		26				9432PVM	5,50	500	8000	
	38	32		32				9438PVM	5,70	500	4000	
	45	41		39				9445PVM	6,70	500	4000	

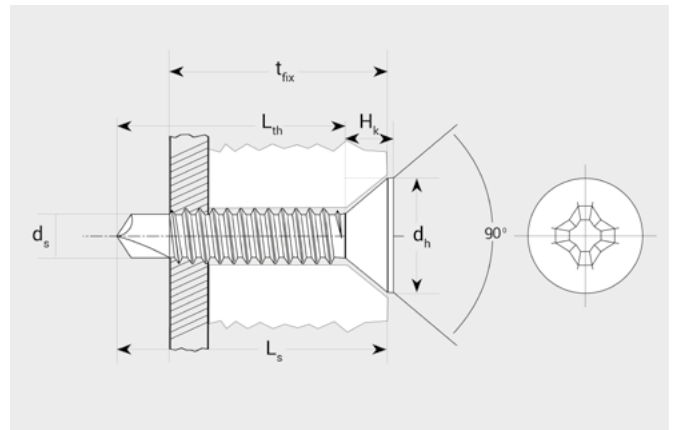

Tornillo para PVC, rosca plástico PVP

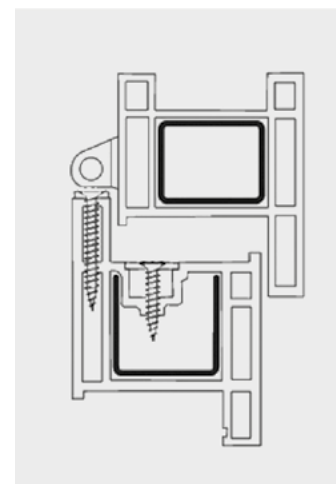

Características

- Cabeza avellanada con estrías.
- Impronta philips (PH).
- Punta S.



PVP Cincado							Precios		Envase	Embalaje
d_s [mm]	L_s [mm]	L_{th} [mm]	d_h [mm]	H_k [mm]	Impronta	Código	Precio €/100 u.	Envase (Uds)	Embalaje (Uds)	
4,1	16	11	7,3	2,8	PH2	94116PVP	3,00	1000	16000	
	19	14				94119PVP	3,20	1000	16000	
	22	17				94122PVP	3,60	500	8000	
	25	20				94125PVP	3,90	500	8000	
	30	25				94130PVP	4,10	500	8000	
	38	33				94138PVP	5,10	500	4000	
	45	40				94145PVP	5,90	500	4000	
	55	50				94155PVP	7,50	250	2000	

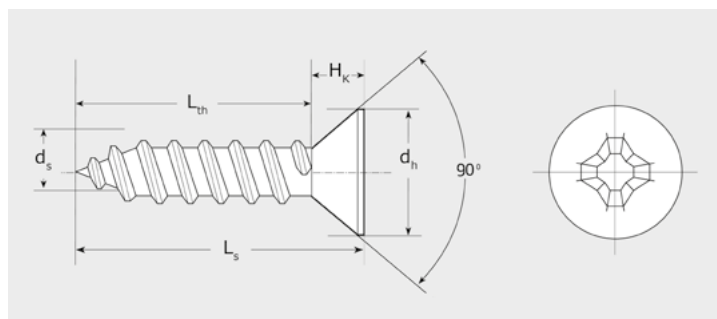

PVP Bicromatado							Precios		Envase	Embalaje
d_s [mm]	L_s [mm]	L_{th} [mm]	d_h [mm]	H_k [mm]	Impronta	Código	Precio €/100 u.	Envase (Uds)	Embalaje (Uds)	
4,1	38	33	7,3	2,8	PH2	9B4138PVP	5,10	500	4000	



PVP Lacado blanco							Precios		Envase	Embalaje
d_s	L_s	L_{th}	d_h	H_k	Impronta	Código	Precio €/100 u.	Envase (Uds)	Embalaje (Uds)	
4,1	25	20	7,3	2,8	PH2	9W4125PVP	10,50	500	8000	
	38	33				9W4138PVP	13,90	500	4000	

Diámetros del agujero para tornillos rosca chapa

Rosca de tornillo para chapa		Espesor de chapa		Diámetro del agujero (1)	
Diámetro nominal	Según ISO 1478	Más de	Hasta	Taladrado o punzonado	
				Chapas de acero, níquel, latón, cobre y monel	Chapas de aluminio
2,2	N. 2	-	0,5	1,6	-
		0,6	0,7	1,7	1,6
		0,8	0,9	1,8	1,6
		1	1,10	1,8	1,6
		1,2	1,3	1,8	1,7
		1,4	1,5	1,9	1,8
2,9	N. 4	-	0,5	2,2	-
		0,5	0,6	2,2	-
		0,6	0,7	2,2	2,2
		0,7	0,8	2,4	2,2
		0,9	1,2	2,4	2,2
		1,3	1,4	2,4	2,2
3,5	N. 6	1,5	1,7	2,5	2,2
		1,8	2,5	2,6	2,4
		-	0,5	2,6	-
		0,6	0,7	2,7	-
		0,8	0,9	2,7	2,6
		1	1,2	2,8	2,6
3,9	N. 7	1,3	1,4	2,8	2,6
		1,5	1,7	2,9	2,7
		1,8	2,5	3	2,8
		2,5	3	3,2	3
		3	6	-	3
		-	0,5	2,9	-
4,2	N. 8	0,5	0,6	2,9	-
		0,6	0,8	2,9	2,9
		0,9	1,1	2,9	2,9
		1,1	1,2	3	2,9
		1,2	1,4	3	2,9
		1,5	1,7	3,2	3
4,8	N. 10	1,8	2	3,2	3,5
		2	2,5	3,5	3,5
		2,5	3,5	3,6	3,5
		-	0,5	-	-
		0,5	0,6	3,2	-
		0,6	0,9	3,2	2,9
5,5	N. 12	0,9	1,1	3,2	3
		1,2	1,4	3,3	3,2
		1,5	2,5	3,5	3,5
		2,5	3	3,8	3,7
		3	3,5	3,9	3,8
		3,5	10	-	3,9
6,3	N. 14	-	0,5	-	-
		0,5	0,7	3,7	-
		0,8	1,1	3,7	3,7
		1,2	1,4	3,9	3,7
		1,5	1,7	3,9	3,7
		1,8	2,5	4	3,8
6,3	N. 14	2,5	3	4,1	3,8
		3	3,5	4,3	3,9
		3,5	4	4,4	3,9
		4	4,7	4,4	4
		4,8	10	-	4,2
		-	1,1	4,2	-
6,3	N. 14	1,2	1,4	4,3	4,1
		1,4	1,5	4,3	4,1
		1,5	1,7	4,5	4,2
		1,8	2,2	4,6	4,4
		2,3	3	4,7	4,6
		3	3,5	5	4,6
6,3	N. 14	3,5	4	5	4,8
		4	4,7	5,1	4,8
		4,8	10	-	4,9
		-	1,4	4,9	-
		1,5	1,7	5	5
		1,8	2	5,2	5
6,3	N. 14	2	3	5,3	5,2
		3	4	5,8	5,3
		4	4,7	5,9	5,4
		4,8	5	-	5,6
		5	10	-	5,8
		-	10	-	5,8

(1) Tolerancia recomendada para el diámetro: H12.

Ø hasta 3 mm + 0,10

- 0

Ø 3 hasta 6 mm + 0,12

- 0

Los diámetros del agujero del núcleo indicados en esta tabla han sido averiguados

en ensayos y sirven solo como orientación. Se aconseja realizar ensayos propios para confirmar estos datos.

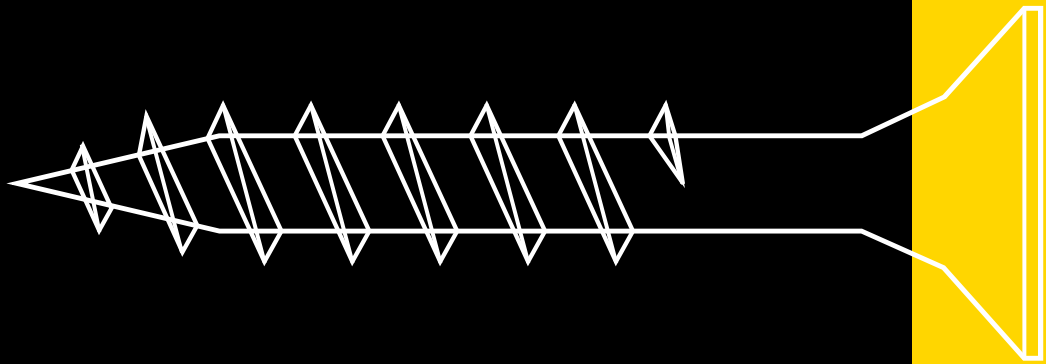

Tornillos rosca madera y composites

Tornillo rosca total madera VELOX® S	278
Tornillo rosca parcial madera VELOX® SP	279
Tornillo rosca total madera VELOX® PZ	280
Tornillo rosca parcial madera VELOX® PZ P	283
Tornillo rosca madera VELOX® B	284
Tornillo rosca madera Inoxidable DIN 7505A	285
Tapón adhesivo MTAP	286
Tornillo para madera DM VELOX® MDF	287
Tornillo de regulación JS	288
Tornillo métrico tirador TIR	288
Tornillo métrico cortable TIRM	289
Tornillo cabeza gota sebo BC	289
Tornillo cabeza reducida BPL	290
Tornillo cabeza ancha CM	290

Tornillo ensamblaje ENE	291
Tornillo doble rosca RA86	291
Tornillo cabeza alomada broca aleta CBTON	292
Maletín tornillería M1	292
Tornillo avellanado broca aleta CBH / CBT	293
Tornillo para fenólico FEC/FEP	294
Tornillo de construcción BMax	295
Tirafondo con arandela FTX71	297
Tornillo tirafondo DIN 571	298
Tornillo inox cabeza botón BTW	299
Tornillo inviolable TIC	300

VELOX®

Reduce el agrietamiento



European Technical Assessment
para uso en construcciones de
madera

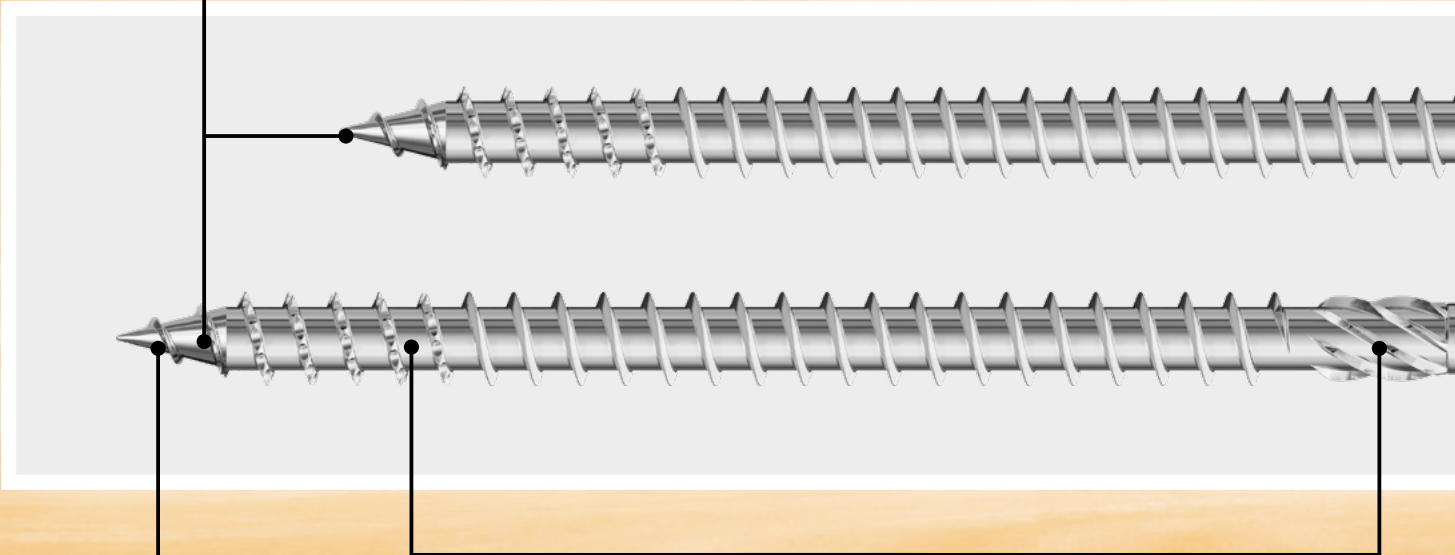

Rosca cortante

Par de montaje
reducido

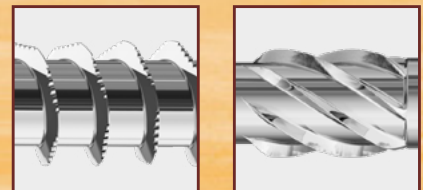

Caja robusta con ventana
y etiqueta

La cabeza queda enrasada tanto en madera como en metal

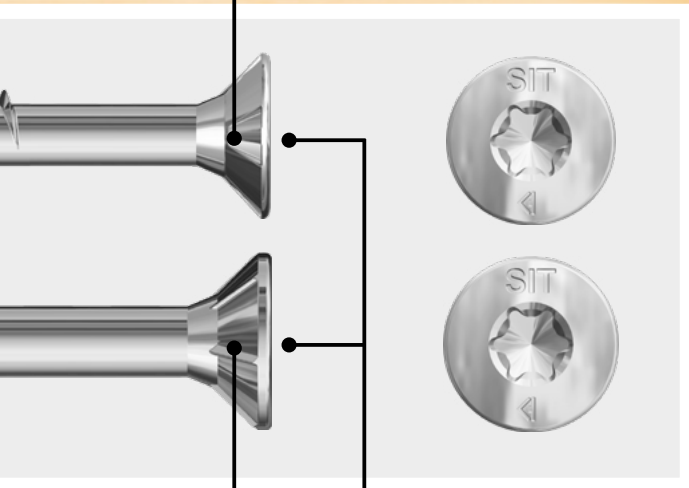
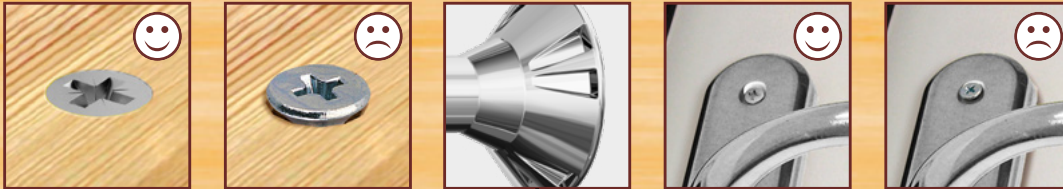

SIT® - Impronta

Ø	Tamaño punta	Ventajas
3,0	10	1 punta para 4 diámetros de tornillos
3,5*	20	
4,0	20	
4,5	20	
5,0**	20	Sin cambios de punta
6,0	30	

* para acero inoxidable: SIT 10
 ** para acero inoxidable: SIT 25

Transferencia perfecta del PAR, bajo desgaste y ajuste perfecto en la punta SIT

Innovador Impronta - SIT®:

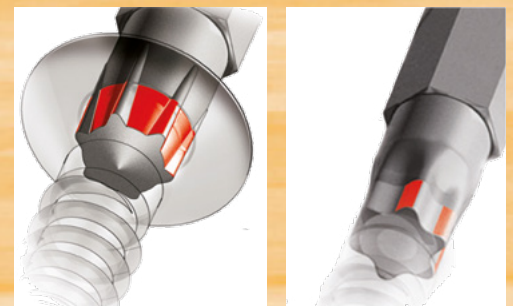

Impronta-SIT® Impronta-TX

La cabeza queda enrasada



Tornillo rosca total madera

VELOX[®] S



Cincado

Características

- Cabeza avellanada.
- Rosca lobular. Corta como un bisturí, reduce el agrietamiento de la madera y aumenta la productividad.
- Lubricado.
- Impronta SIT[®]. Permite un encaje perfecto para atornillar fácilmente.
- Punta S.

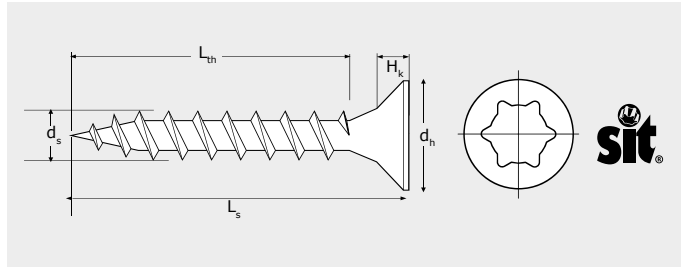

d_s : Diámetro tornillo L_{th} : Parte roscada. H_k : Altura de cabeza.
 L_s : Longitud tornillo. d_h : Diámetro cabeza.

Cajas

VELOX S Cincado								Precios		Envase	Embalaje
	d_s [mm]	L_s [mm]	L_{th} [mm]	d_h [mm]	H_k [mm]	Impronta	·	Código	Precio €/100 u.	·	·
sin estrias	3	13	T	6	1,9	SIT20	-	9313VLOXS	2,10	1.000	32.000
		15					-	9315VLOXS	2,10	1.000	16.000
		17					-	9317VLOXS	2,10	1.000	16.000
		20					-	9320VLOXS	2,30	1.000	16.000
		25					-	9325VLOXS	20,40	1.000	16.000
	30					-	9330VLOXS	3,50	1.000	8.000	
estrias s	3,5	15	T	7	2,4	SIT20	-	93515VLOXS	2,30	1.000	16.000
		17					-	93517VLOXS	2,40	1.000	16.000
		20					-	93520VLOXS	2,60	1.000	16.000
		25					-	93525VLOXS	2,70	1.000	8.000
		30					-	93530VLOXS	3,50	1.000	8.000
	35					-	93535VLOXS	4,30	500	8.000	
eif estrias	4	17	T	8	2,5	SIT20	-	9417VLOXS	3,30	1.000	16.000
		20					-	9420VLOXS	3,50	1.000	8.000
		25					-	9425VLOXS	3,70	1.000	8.000
		30					-	9430VLOXS	4,00	500	8.000
		35					-	9435VLOXS	4,60	500	4.000
estrias e-type		40					-	9440VLOXS	4,90	500	4.000
		45					-	9445VLOXS	6,20	500	4.000
		50					-	9450VLOXS	6,90	500	4.000
		60					-	9460VLOXS	12,00	250	2.000
	estrias e-type	4,5	30	T	9	2,7	SIT20	-	94530VLOXS	5,20	500
		35					-	94535VLOXS	5,80	500	4.000
		40					-	94540VLOXS	6,30	500	4.000
		45					-	94545VLOXS	7,80	250	2.000
estrias e-type	5	30	T	10	3,0	SIT20	-	9530VLOXS	7,30	250	4.000
		35					-	9535VLOXS	7,70	250	4.000
		50					-	9550VLOXS	9,80	250	2.000
		60					-	9560VLOXS	12,10	250	2.000
		70					-	9570VLOXS	16,00	200	1.600
	80					-	9580VLOXS	19,30	100	800	

T Rosca total

Cajas

VELOX S Inox A2								Precios		Envase	Embalaje
	d_s [mm]	L_s [mm]	L_{th} [mm]	d_h [mm]	H_k [mm]	Impronta	·	Código	Precio €/100 u.	·	·
sin estrias	3	20	T	6	1,9	SIT10	-	9X320VLOXS	8,50	1.000	16.000
		30					-	9X330VLOXS	10,70	1.000	8.000
	3,5	20	T	7	2,4	SIT10	-	9X3520VLOXS	13,20	1.000	16.000
		25					-	9X3525VLOXS	14,10	1.000	16.000
	30					-	9X3530VLOXS	17,10	1.000	8.000	
estrias standard	4	25	T	8	2,5	SIT20	-	9X425VLOXS	18,50	1.000	8.000
		30					-	9X430VLOXS	20,60	500	8.000
		35					-	9X435VLOXS	22,60	500	4.000
	4,5	30	T	9	2,7	SIT20	-	9X4530VLOXS	21,60	500	4000

T Rosca total

Tornillo rosca parcial madera

VELOX® SP



Cincado

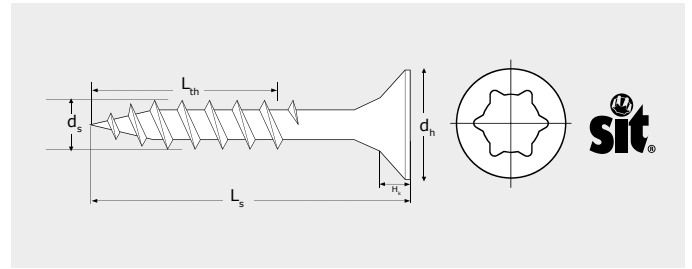

d_s : Diámetro tornillo L_{th} : Parte roscada. H_k : Altura de cabeza.
 L_s : Longitud tornillo. d_h : Diámetro cabeza.

Características

- Cabeza avellanada.
- Rosca lobular. Corta como un bisturí, reduce el agrietamiento de la madera y aumenta la productividad.
- Impronta SIT®. Permite un encaje perfecto para atornillar fácilmente.
- Punta S.
- Rosca rápida a partir de 6x70.

Cajas

VELOX SP Cincado								Precios		Envase	Embalaje
sin estrías	d_s [mm]	L_s [mm]	L_{th} [mm]	d_h [mm]	H_k [mm]	Impronta	·	Código	Precio €/100 u.	(Uds)	(Uds)
	3	35	20	6	1,9	SIT10	·	9335VLOXSP	4,00	1.000	8.000
	3,5	35	20	7	2,4	SIT20	·	93535VLOXSP	4,30	500	8.000
		40	25				·	93540VLOXSP	4,80	500	4.000
estriás		45	30				·	93545VLOXSP	7,60	500	4.000
		50	30				·	93550VLOXSP	8,20	500	4.000
	4	40	25	8	2,5	SIT20	·	9440VLOXSP	4,90	500	4.000
		45	30				·	9445VLOXSP	6,20	500	4.000
estriás e-type		50	30				·	9450VLOXSP	6,90	500	4.000
		60	35				·	9460VLOXSP	12,00	250	2.000
		70	40				·	9470VLOXSP	15,70	200	1.600
	4,5	40	25	9	2,7	SIT20	·	94540VLOXSP	6,30	500	4.000
		45	30				·	94545VLOXSP	7,80	250	2.000
estriás e-type		50	30				·	94550VLOXSP	8,60	250	2.000
		60	35				·	94560VLOXSP	11,00	250	2.000
		70	40				·	94570VLOXSP	15,70	200	1.600
		80	50				·	94580VLOXSP	18,10	100	800
	5	40	25	10	3	SIT20	·	9540VLOXSP	6,90	500	4.000
		45	30				·	9545VLOXSP	8,10	250	2.000
		50	30				·	9550VLOXSP	8,60	250	2.000
		60	35				·	9560VLOXSP	10,60	250	2.000
estriás e-type		70	40				·	9570VLOXSP	14,00	200	1.600
		80	50				·	9580VLOXSP	16,70	100	800
		90	60				·	9590VLOXSP	24,20	100	800
		100	60				·	95100VLOXSP	28,70	50	400

Cajas

VELOX SP Inox A2								Precios		Envase	Embalaje
sin estrías	d_s [mm]	L_s [mm]	L_{th} [mm]	d_h [mm]	H_k [mm]	Impronta	·	Código	Precio €/100 u.	(Uds)	(Uds)
	3,5	40	25	7	2,4	SIT10	·	9X3540VLOXSP	26,80	500	4.000
	4	40	25	8	2,5	SIT20	·	9X440VLOXSP	27,20	500	4.000
		50	30				·	9X450VLOXSP	38,90	500	4.000
		60	35				·	9X460VLOXSP	51,30	250	2.000
estriás standar	4,5	40	25	9	2,7	SIT20	·	9X4540VLOXSP	28,20	500	4.000
		50	30				·	9X4550VLOXSP	38,00	250	2.000
estriás e-type		70	40				·	9X4570VLOXSP	48,10	200	1.600
	5	90	60	10	3	SIT25	·	9X590VLOXSP	99,20	100	800
	6	50	30	12	3,6	SIT30	·	9X650VLOXSP	54,70	250	2.000
estriás standar		60	35				·	9X660VLOXSP	72,60	200	1.600
		70	40				·	9X670VLOXSP	99,20	100	800
		80	50				·	9X680VLOXSP	120,60	100	800
		90	60				·	9X690VLOXSP	132,20	50	400
		120	70				·	9X6120VLOXSP	210,00	100	800

*Con rosca rápida.

Tornillo rosca total madera

VELOX® PZ



Cincado

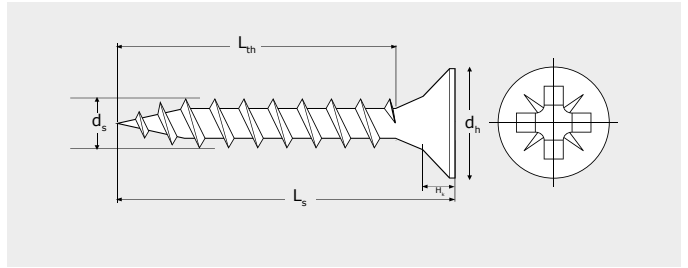

d_s : Diámetro tornillo L_{th} : Parte roscada. H_k : Altura de cabeza.
 L_s : Longitud tornillo. d_h : Diámetro cabeza.

Características

- Cabeza avellanada.
- Rosca lobular. Corta como un bisturí, reduce el agrietamiento de la madera y aumenta la productividad.
- Estrías e-type.
- Punta S.

Cajas

VELOX PZ Cincado								Precios		Envase	Embalaje
d_s [mm]	L_s [mm]	L_{th} [mm]	d_h [mm]	H_k [mm]	Impronta		Código	Precio €/100 u.	(Uds)	(Uds)	
2,5	10	T	5	1,5	PZ1	-	92510VLOX	1,90	1.000	32.000	
	13					-	92513VLOX	1,90	1.000	32.000	
	15					-	92515VLOX	1,90	1.000	32.000	
	17					-	92517VLOX	1,90	1.000	32.000	
	20					-	92520VLOX	2,00	1.000	16.000	
	25					-	92525VLOX	2,30	1.000	16.000	
30					-	92530VLOX	3,10	1.000	16.000		
3	10	T	6	1,9	PZ1	-	9310VLOX	1,70	1.000	32.000	
	13					-	9313VLOX	1,70	1.000	32.000	
	15					-	9315VLOX	1,70	1.000	32.000	
	17					-	9317VLOX	1,90	1.000	16.000	
	20					-	9320VLOX	2,00	1.000	16.000	
	25					-	9325VLOX	2,10	500	16.000	
30					-	9330VLOX	2,70	1.000	8.000		
3,5	10	T	7	2,4	PZ2	-	93510VLOX	2,00	1.000	32.000	
	13					-	93513VLOX	2,10	1.000	32.000	
	15					-	93515VLOX	2,10	1.000	16.000	
	17					-	93517VLOX	2,10	1.000	16.000	
	20					-	93520VLOX	2,30	1.000	16.000	
	25					-	93525VLOX	2,50	1.000	16.000	
30					-	93530VLOX	3,10	1.000	8.000		
3,5	30					-	93530VLOX200	3,30	200	6.400	
	35					-	93535VLOX	3,80	500	8.000	
	35					-	93535VLOX200	4,10	200	6.400	
	40					-	93540VLOX	4,40	500	4.000	
	40					-	93540VLOX200	4,70	200	6.400	
	45					-	93545VLOX	6,80	500	4.000	
	45					-	93545VLOX200	7,40	200	3.200	
	50					-	93550VLOX	7,30	500	4.000	
	50					-	93550VLOX200	7,80	200	3.200	
	4	15	T	8	2,5	PZ2	-	9415VLOX	2,70	1.000	16.000
17						-	9417VLOX	2,70	1.000	16.000	
20						-	9420VLOX	2,80	1.000	16.000	
20						-	9420VLOX200	3,20	200	6.400	
25						-	9425VLOX	3,90	1.000	8.000	
25						-	9425VLOX200	3,60	200	6.400	
30						-	9430VLOX	3,60	500	8.000	
30						-	9430VLOX200	3,90	200	6.400	
35						-	9435VLOX	4,10	500	4.000	
35						-	9435VLOX200	4,50	200	6.400	
40						-	9440VLOX	4,50	500	4.000	
40						-	9440VLOX200	4,90	200	3.200	
45					-	9445VLOX	5,60	500	4.000		
45					-	9445VLOX200	6,20	200	3.200		
50					-	9450VLOX	6,20	500	4.000		
50					-	9450VLOX200	6,80	200	3.200		
60					-	9460VLOX	10,60	250	2.000		
60					-	9460VLOX150	11,60	150	2.400		

VELOX PZ Cincado								Precios		Envase	Embalaje
d_s [mm]	L_s [mm]	L_{th} [mm]	d_h [mm]	H_k [mm]	Impronta		Código	Precio €/100 u.	(Uds)	(Uds)	
4,5	15	T	9	2,7	PZ2	-	94515VLOX	3,10	500	8.000	
	20					-	94520VLOX	3,50	500	8.000	
	25					-	94525VLOX	4,00	500	8.000	
	30					-	94530VLOX	4,50	500	4.000	
	30					-	94530VLOX200	4,80	200	6.400	
	35					-	94535VLOX	4,90	500	4.000	
	35					-	94535VLOX200	5,30	200	3.200	
	40					-	94540VLOX	5,50	500	4.000	
	40					-	94540VLOX200	6,10	200	3.200	
	45					-	94545VLOX	6,90	200	4.000	
	50					-	94550VLOX	7,40	250	2.000	
	50					-	94550VLOX200	8,20	200	3.200	
5	60					-	94560VLOX	9,60	250	2.000	
	60					-	94560VLOX150	10,50	150	2.400	
	70					-	94570VLOX	13,60	250	2.000	
	70					-	94570VLOX100	14,70	100	1.600	
	5	25	T	10	3	PZ2	-	9525VLOX	5,10	500	8.000
		30					-	9530VLOX	6,00	250	4.000
		35					-	9535VLOX	6,30	250	4.000
		40					-	9540VLOX	6,80	500	4.000
		40					-	9540VLOX250	7,40	250	4.000
		45					-	9545VLOX	8,10	250	2.000
		45					-	9545VLOX200	8,50	200	3.200
		50					-	9550VLOX	8,60	250	2.000
50						-	9550VLOX200	9,50	200	3.200	
60						-	9560VLOX	10,60	250	2.000	
60						-	9560VLOX125	11,60	125	3.200	
70						-	9570VLOX	14,00	200	1.600	
70					-	9570VLOX90	15,40	90	1.440		
80					-	9580VLOX	16,70	100	800		
80					-	9580VLOX70	18,40	70	1.120		

T Rosca total

Cajas

VELOX PZ Bicromatado								Precios		Envase	Embalaje
d _s [mm]	L _s [mm]	L _{th} [mm]	d _h [mm]	H _k [mm]	Impronta		Código	Precio €/100 u.			
sin estrias	2,5	10	T	5	1,5	PZ1	-	9B2510VLOX	1,90	1.000	32.000
		13					-	9B2513VLOX	1,90	1.000	32.000
		15					-	9B2515VLOX	1,90	1.000	32.000
		17					-	9B2517VLOX	1,90	1.000	32.000
		20					-	9B2520VLOX	2,00	1.000	32.000
		25					-	9B2525VLOX	2,30	1.000	16.000
	30					-	9B2530VLOX	3,10	1.000	16.000	
sin estrias	3	10	T	6	1,9	PZ1	-	9B310VLOX	1,70	1.000	32.000
		13					-	9B313VLOX	1,70	1.000	32.000
		15					-	9B315VLOX	1,70	1.000	32.000
		15					-	9B315VLOX300	2,00	300	9.600
		17					-	9B317VLOX	1,90	1.000	16.000
		17					-	9B317VLOX300	2,00	300	9.600
		20					-	9B320VLOX	2,00	1.000	16.000
		20					-	9B320VLOX300	2,20	300	9.600
		25					-	9B325VLOX	2,10	500	16.000
		25					-	9B325VLOX300	2,40	300	9.600
estrias e-type	3,5	10	T		2,4	PZ2	-	9B3510VLOX	2,00	1.000	32.000
		13					-	9B3513VLOX	2,10	1.000	32.000
		15					-	9B3515VLOX	2,10	1.000	16.000
		17					-	9B3517VLOX	2,10	1.000	16.000
		20					-	9B3520VLOX	2,30	1.000	16.000
		25					-	9B3525VLOX	2,50	1.000	16.000
		30					-	9B3530VLOX	3,10	1.000	8.000
		30					-	9B3530VLOX200	3,30	200	6.400
		35					-	9B3535VLOX	3,80	500	8.000
		35					-	9B3535VLOX200	4,10	200	6.400
estrias e-type	4	15	T	8	2,5	PZ2	-	9B415VLOX	2,70	1.000	16.000
		17					-	9B417VLOX	2,70	1.000	16.000
		20					-	9B420VLOX	2,80	1.000	16.000
		20					-	9B420VLOX200	3,20	200	6.400
		25					-	9B425VLOX	3,30	1.000	8.000
		25					-	9B425VLOX200	3,60	200	6.400
		30					-	9B430VLOX	3,60	500	8.000
		30					-	9B430VLOX200	3,90	200	6.400
		35					-	9B435VLOX	4,10	500	4.000
		35					-	9B435VLOX200	4,50	200	6.400
estrias e-type	4	30					-	9B440VLOX	4,50	500	4.000
		40					-	9B440VLOX200	4,80	200	3.200
		45					-	9B445VLOX	5,60	500	4.000
		45					-	9B445VLOX200	6,10	200	3.200
		50					-	9B450VLOX	6,10	500	4.000
		50					-	9B450VLOX200	6,60	200	3.200
		60					-	9B460VLOX	10,60	250	2.000

T Rosca total

Cajas

VELOX PZ Bicromatado								Precios		Envase	Embalaje
d _s [mm]	L _s [mm]	L _{th} [mm]	d _h [mm]	H _k [mm]	Impronta		Código	Precio €/100 u.			
estrias e-type	4,5	20	T	9	2,7	PZ2	-	9B4520VLOX	3,50	500	8.000
		25					-	9B4525VLOX	4,00	500	8.000
		30					-	9B4530VLOX	4,50	500	4.000
		30					-	9B4530VLOX200	4,80	200	6.400
		35					-	9B4535VLOX	4,90	500	4.000
		35					-	9B4535VLOX200	5,30	200	3.200
		40					-	9B4540VLOX	5,50	500	4.000
		40					-	9B4540VLOX200	6,00	200	3.200
		45					-	9B4545VLOX	6,90	200	4.000
		50					-	9B4550VLOX	7,40	250	2.000
estrias e-type	5	20	T	10	3,0	PZ2	-	9B4560VLOX	9,60	250	2.000
		25					-	9B4570VLOX	13,60	250	2.000
		30					-	9B525VLOX	5,10	500	8.000
		30					-	9B530VLOX	6,00	250	4.000
		35					-	9B535VLOX	6,30	250	4.000
		40					-	9B540VLOX	6,80	500	4.000
		45					-	9B545VLOX	8,10	250	2.000
		50					-	9B550VLOX	8,60	250	2.000
		60					-	9B560VLOX	10,60	250	2.000
		70					-	9B570VLOX	14,00	200	1.600
estrias	6	40	T	12	3,6	PZ3	-	9B580VLOX	16,70	100	800
		40					-	9B640VLOX	13,60	250	2.000
		50					-	9B640VLOX175	14,90	175	1.400
		50					-	9B650VLOX	14,20	250	2.000
		50					-	9B650VLOX150	15,60	150	2.400
		60					-	9B660VLOX	14,50	200	1.600
		60					-	9B660VLOX100	16,40	100	1.600
		70					-	9B670VLOX	19,60	100	800
		70					-	9B670VLOX80	21,50	80	1.280
		80					-	9B680VLOX	22,60	100	800
	80					-	9B680VLOX50	24,40	50	800	

T Rosca total

VELOX PZ Cincado Negro								Precios		Envase	Embalaje
d _s [mm]	L _s [mm]	L _{th} [mm]	d _h [mm]	H _k [mm]	Impronta		Código	Precio €/100 u.			
2,5	17	T	5	1,4	PZ1	-	9N2517VLOX	2,60	1.000	32.000	
3	20	T	6	1,8	PZ1	-	9N320VLOX	2,70	1.000	16.000	
3,5	20	T	7	2	PZ2	-	9N3520VLOX	3,30	1.000	16.000	
	25					-	9N3525VLOX	3,30	1.000	16.000	
	30					-	9N3530VLOX	4,00	1.000	8.000	
4	20	T	8	2,35	PZ2	-	9N420VLOX	4,10	1.000	16.000	
	30					-	9N430VLOX	4,80	500	8.000	
	40					-	9N440VLOX	6,10	500	4.000	
4,5	40	T	9	2,55	PZ2	-	9N4540VLOX	6,50	500	4.000	

T Rosca total

Blisters

VELOX PZ Bicromatado								Precios		Envase	Embalaje	
d _h [mm]	L _s [mm]	L _{th} [mm]	d _h [mm]	H _k [mm]	Impronta		Código	Precio €/100 u.	 (Uds)	 (Uds)	(Uds x embalaje)	
sin estrias	3	15	T	6	1,8	PZ1	-	4B315VLOX	6,30	230	10	2.300
		15					-	7B315VLOX	3,20	60	10	600
		20					.	4B320VLOX	6,30	210	10	2.100
		20					.	7B320VLOX	3,20	50	10	500
		25					.	4B325VLOX	6,30	190	10	1.900
		25					.	7B325VLOX	3,20	40	10	400
sin estrias	3,5	15	T	7	2	PZ2	-	4B3515VLOX	6,30	210	10	2.100
		15					-	7B3515VLOX	3,20	50	10	500
		20					.	4B3520VLOX	6,30	190	10	1.900
		20					.	7B3520VLOX	3,20	45	10	450
		25					.	4B3525VLOX	6,30	170	10	1.700
		25					.	7B3525VLOX	3,20	40	10	400
		30					.	4B3530VLOX	6,30	140	10	1.400
		30					.	7B3530VLOX	3,20	35	10	350
		35					.	4B3535VLOX	6,30	115	10	1.150
		35					.	7B3535VLOX	3,20	30	10	300
		40					.	4B3540VLOX	6,30	90	10	900
		40					.	7B3540VLOX	3,20	30	10	300
		45					.	4B3545VLOX	6,30	65	10	650
		45					.	7B3545VLOX	3,20	25	10	250
	50					.	4B3550VLOX	6,30	50	10	500	
	50					.	7B3550VLOX	3,20	20	10	200	
sin estrias	4	15	T	8	2,35	PZ2	-	4B415VLOX	6,30	155	10	1.550
		15					-	7B415VLOX	3,20	40	10	400
		20					-	4B420VLOX	6,30	145	10	1.450
		20					-	7B420VLOX	3,20	35	10	350
		25					.	4B425VLOX	6,30	130	10	1.300
		25					.	7B425VLOX	3,20	30	10	300
		30					.	4B430VLOX	6,30	115	10	1.150
		30					.	7B430VLOX	3,20	30	10	300
		35					.	4B435VLOX	6,30	100	10	1.000
		35					.	7B435VLOX	3,20	25	10	250
		40					.	4B440VLOX	6,30	95	10	950
		40					.	7B440VLOX	3,20	20	10	200
		45					.	4B445VLOX	6,30	75	10	750
		45					.	7B445VLOX	3,20	20	10	200
	50					.	4B450VLOX	6,30	70	10	700	
	50					.	7B450VLOX	3,20	20	10	200	
	60					.	4B460VLOX	6,30	45	10	450	
	60					.	7B460VLOX	3,20	15	10	150	
sin estrias	4,5	25	T	9	2,55	PZ2	.	4B4525VLOX	6,30	120	10	1.200
		25					.	7B4525VLOX	3,20	25	10	250
		30					.	4B4530VLOX	6,30	95	10	950
		30					.	7B4530VLOX	3,20	20	10	200
		35					.	4B4535VLOX	6,30	90	10	900
		35					.	7B4535VLOX	3,20	20	10	200
		40					.	4B4540VLOX	6,30	75	10	750
		40					.	7B4540VLOX	3,20	20	10	200
		45					.	4B4545VLOX	6,30	65	10	650
		45					.	7B4545VLOX	3,20	15	10	150
		50					.	4B4550VLOX	6,30	55	10	550
		50					.	7B4550VLOX	3,20	15	10	150
		60					.	4B4560VLOX	6,30	45	10	450
		60					.	7B4560VLOX	3,20	10	10	100
	70					.	4B4570VLOX	6,30	30	10	300	
	70					.	7B4570VLOX	3,20	10	10	100	
sin estrias	5	30	T	10	2,85	PZ2	.	4B530VLOX	6,30	70	10	700
		30					.	7B530VLOX	3,20	15	10	150
		35					.	4B535VLOX	6,30	65	10	650
		35					.	7B535VLOX	3,20	15	10	150
		40					.	4B540VLOX	6,30	60	10	600
		40					.	7B540VLOX	3,20	15	10	150
		50					.	4B550VLOX	6,30	50	10	500
		50					.	7B550VLOX	3,20	10	10	100
		60					.	4B560VLOX	6,30	38	10	380
		60					.	7B560VLOX	3,20	10	10	100
		70					.	4B570VLOX	6,30	10	10	100
		70					.	7B570VLOX	3,20	10	10	100
		80					.	4B580VLOX	6,30	25	10	250
		80					.	7B580VLOX	3,20	10	10	100
sin estrias	6	50	T	12	3,85	PZ3	.	7B650VLOX	3,20	6	10	60
		60					.	7B660VLOX	3,20	6	10	60
		70					.	7B670VLOX	3,20	6	10	60
		80					.	7B680VLOXP	3,20	6	10	60
		90					.	7B690VLOXP	3,20	4	10	40
		100					.	7B6100VLOXP	3,20	4	10	40
		110					.	7B6110VLOXP	3,20	4	10	40
		120					.	7B6120VLOXP	3,20	4	10	40

Tornillo rosca parcial madera

VELOX® PZ P



Cincado

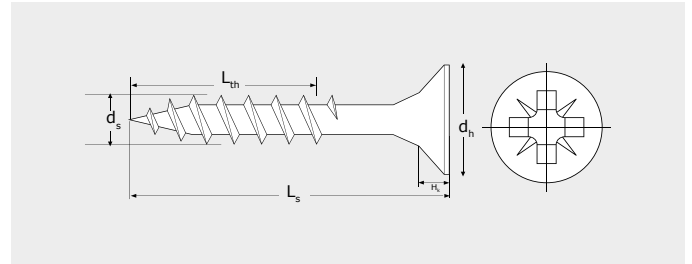

d_s : Diámetro tornillo L_{th} : Parte roscada. H_k : Altura de cabeza.
 L_s : Longitud tornillo. d_h : Diámetro cabeza.

Características

- Cabeza avellanada.
- Rosca lobular. Corta como un bisturí, reduce el agrietamiento de la madera y aumenta la productividad.
- Punta S.

Cajas

VELOX PZP Cincado								Precios		Envase	Embalaje
no estriás	d_s	L_s	L_{th}	d_h	H_k	Impronta	Código	Precio €/100 u.	Uds	Uds	
	[mm]	[mm]	[mm]	[mm]	[mm]						
3	40	25	6	1,90	PZ1	-	9340VLOXP	4,90	500	8.000	
3,5	35	20	7	2,4	PZ2	-	93535VLOXP	3,90	500	8.000	
no estriás	40	25					93540VLOXP	4,40	500	4.000	
	45	30					93545VLOXP	6,90	500	4.000	
	50	30					93550VLOXP	7,40	500	4.000	
no estriás	4	40	25	8	2,5	PZ2	-	9440VLOXP	4,50	500	4.000
	45	30					9445VLOXP	5,60	500	4.000	
	50	30					9450VLOXP	6,20	500	2.000	
no estriás	60	35					9460VLOXP	10,60	250	2.000	
	70	40					9470VLOXP	13,60	250	2.000	
	70	40					9470VLOXP100	14,90	100	1.600	
no estriás	4,5	45	30	9	2,7	PZ2	-	94545VLOXP	6,90	250	2.000
	50	30					94550VLOXP	7,40	250	2.000	
	60	35					94560VLOXP	9,60	250	2.000	
no estriás	70	40					94570VLOXP	13,60	200	1.600	
	80	50					94580VLOXP	15,80	100	800	
	80	50					94580VLOXP50	17,30	50	800	
estriás e-type	5	40	25	10	3	PZ2	-	9540VLOXP	6,90	500	4.000
	45	30					9545VLOXP	8,10	250	2.000	
	50	30					9550VLOXP	8,60	250	2.000	
no estriás	60	35					9560VLOXP	10,60	250	2.000	
	70	40					9570VLOXP	14,00	200	1.600	
	80	50					9580VLOXP	16,70	100	800	
no estriás	90	60					9590VLOXP	20,90	100	800	
	90	60					9590VLOXP60	23,00	60	960	
	100	60					95100VLOXP	24,90	100	800	
100	60					95100VLOXP40	27,40	40	640		

Cajas

VELOX PZP Bicromatado								Precios		Envase	Embalaje
no estriás	d_s	L_s	L_{th}	d_h	H_k	Impronta	Código	Precio €/100 u.	Uds	Uds	
	[mm]	[mm]	[mm]	[mm]	[mm]						
3	40	25	6	1,9	PZ1	-	9B340VLOXP	4,90	500	8.000	
3,5	35	20	7	2,4	PZ2	-	9B3535VLOXP	3,90	500	8.000	
no estriás	40	25					9B3540VLOXP	4,40	500	4.000	
	45	30					9B3545VLOXP	6,90	500	4.000	
	50	30					9B3550VLOXP	7,40	500	4.000	
no estriás	4	40	25	8	2,5	PZ2	-	9B440VLOXP	4,50	500	4.000
	45	30					9B445VLOXP	5,60	500	4.000	
	50	30					9B450VLOXP	6,20	500	2.000	
no estriás	60	35					9B460VLOXP	10,60	250	2.000	
	70	40					9B470VLOXP	13,60	250	2.000	
	70	40					9B470VLOXP	13,60	250	2.000	
no estriás	4,5	40	25	9	2,7	PZ2	-	9B4540VLOXP	5,60	500	4.000
	45	30					9B4545VLOXP	6,90	250	2.000	
	50	30					9B4550VLOXP	7,40	250	2.000	
no estriás	60	35					9B4560VLOXP	9,60	250	2.000	
	70	40					9B4570VLOXP	13,60	200	1.600	
	80	50					9B4580VLOXP	15,80	100	800	
no estriás	5	40	25	10	3	PZ2	-	9B540VLOXP	6,90	500	4.000
	45	30					9B545VLOXP	8,10	250	2.000	
	50	30					9B550VLOXP	8,60	250	2.000	
no estriás	60	35					9B560VLOXP	10,60	250	2.000	
	70	40					9B570VLOXP	14,00	200	1.600	
	80	50					9B580VLOXP	16,70	100	800	
no estriás	90	60					9B590VLOXP	20,90	100	800	
	100	60					9B5100VLOXP	24,90	100	800	
	100	60					9B5100VLOXP	24,90	100	800	
estriás e-type	6	50	30	12	3,6	PZ3	-	9B650VLOXP	14,10	250	2.000
	60	35					9B660VLOXP	14,50	200	1.000	
	70	40					9B670VLOXP	19,00	100	800	
no estriás	80	50					9B680VLOXP	22,20	100	800	
	90	60					9B690VLOXP	24,60	50	400	
	100	60					9B6100VLOXP	28,80	50	800	
no estriás	100	60					9B6100VLOXP30	31,60	30	480	
	110	70					9B6110VLOXP	38,90	100	800	
	120	70					9B6120VLOXP	45,10	100	800	
no estriás	130	70					9B6130VLOXP	51,10	100	800	
	140	70					9B6140VLOXP	63,50	100	800	
	150	70					9B6150VLOXP	71,60	100	400	
no estriás	160	70					9B6160VLOXP	75,90	100	400	
	180	70					9B6180VLOXP	109,40	100	400	
	200	70					9B6200VLOXP	156,30	100	400	
220	70					9B6220VLOXP	171,90	50	200		

*Con rosca rápida

Blister

VELOX PZP Cincado								Precios		Envase	Embalaje	Embalaje
d_s	L_s	L_{th}	d_h	H_k	Impronta		Código	Precio €/100 u.	Uds	Uds	Uds	
												[mm]
6	80	50	12	3,6	PZ3	-	7B680VLOXP	3,20	6	10	60	
90	60						7B690VLOXP	3,20	4	10	40	
100	60						7B6100VLOXP	3,20	4	10	40	
110	70						7B6110VLOXP	3,20	4	10	40	
120	70						7B6120VLOXP	3,20	4	10	40	

*Con rosca rápida

Tornillo rosca madera

VELOX® B



Cincado

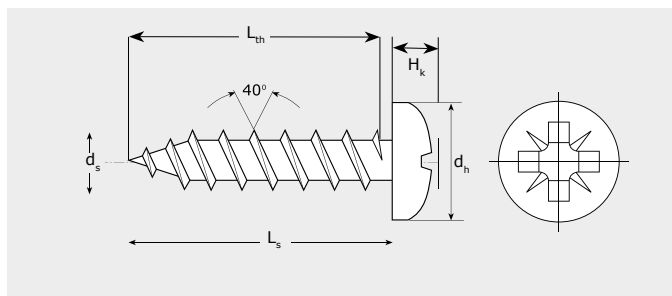

d_s : Diámetro tornillo L_{th} : Parte roscada. H_k : Altura de cabeza.
 L_s : Longitud tornillo. d_h : Diámetro cabeza.

Características

- Cabeza alomada.
- Impronta Pozi (PZ).
- Rosca lobular. Corta como un bisturí, reduce el agrietamiento de la madera y aumenta la productividad.
- Punta S.

VELOX B Cincado							Precios		Envase	Embalaje
d_s [mm]	L_s [mm]	L_{th} [mm]	d_h [mm]	H_k [mm]	Impronta		Código	Precio €/100 u.	 (Uds)	 (Uds)
2,5	15	T	5	2	PZ1	-	92515VLOXB	2,20	1.000	32.000
3	10	T	6	2,4	PZ1	-	9310VLOXB	2,40	1.000	32.000
	15						9315VLOXB	2,50	1.000	16.000
	17						9317VLOXB	2,50	1.000	16.000
	20						9320VLOXB	2,60	1.000	16.000
3,5	10	T	7	2,6	PZ2	-	93510VLOXB	2,80	1.000	16.000
	13						93513VLOXB	3,20	1.000	16.000
	15						93515VLOXB	3,20	1.000	16.000
	17						93517VLOXB	3,20	1.000	16.000
	20						93520VLOXB	3,50	1.000	8.000
	25						93525VLOXB	3,80	1.000	8.000
	30						93530VLOXB	4,70	1.000	8.000
	35						93535VLOXB	4,70	500	4.000
	40						93540VLOXB	5,60	500	4.000
4	15	T	8	2,9	PZ2	-	9415VLOXB	3,90	1.000	16.000
	17						9417VLOXB	3,90	1.000	8.000
	20						9420VLOXB	4,00	1.000	8.000
	25						9425VLOXB	4,50	1.000	8.000
	30						9430VLOXB	4,90	500	4.000
	35						9435VLOXB	5,80	500	4.000
	40						9440VLOXB	6,60	500	4.000
	50						9450VLOXB	8,60	250	2.000
	60						9460VLOXB	11,40	250	2.000
4,5	20	T	9	3,2	PZ2	-	94520VLOXB	5,60	2.000	8.000
	25						94525VLOXB	6,00	2.000	4.000
	30						94530VLOXB	6,60	2.000	4.000
	35						94535VLOXB	7,40	2.000	4.000
	40						94540VLOXB	8,10	2.000	4.000
	45						94545VLOXB	10,00	1.000	2.000
	50						94550VLOXB	11,30	1.000	2.000
5	25	T	10	3,6	PZ2	-	9525VLOXB	7,20	500	4.000
	30						9530VLOXB	8,40	250	4.000
	35						9535VLOXB	9,80	250	4.000
	40						9540VLOXB	10,50	250	2.000

T Rosca total

Tornillo rosca madera Inoxidable **DIN 7505A**



Inox



Características

- Cabeza avellanada.
- Impronta Pozi (PZ).
- Punta S.

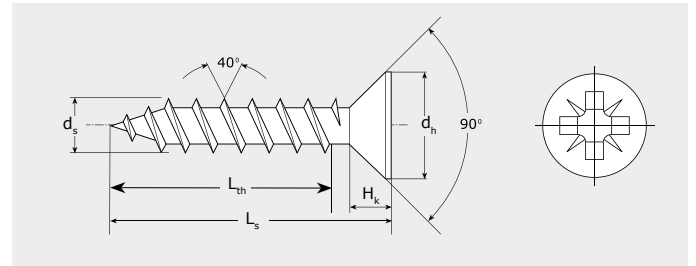

d_s : Diámetro tornillo L_{th} : Parte roscada. H_k : Altura de cabeza.
 L_s : Longitud tornillo. d_h : Diámetro cabeza.

DIN 7505A Inox. A2						Precios		Envase	Embalaje
d_s [mm]	L_s [mm]	L_{th} [mm]	d_h [mm]	H_k [mm]	Impronta	Código	Precio €/100 u.	(Uds)	(Uds)
3,5	16	T	7	1,75	PZ2	9X35167505A	7,80	1000	8000
	20	9X35207505A				8,50	1000	8000	
	25	9X35257505A				9,10	1000	8000	
	30	9X35307505A				11,10	1000	8000	
	35	9X35357505A				12,00	500	4000	
	40	9X35407505A				17,40	500	4000	
4	20	T	8	2	PZ2	9X4207505A	10,80	1000	8000
	25	9X4257505A				11,90	1000	8000	
	30	9X4307505A				13,20	500	4000	
	35	9X4357505A				14,40	500	4000	
	40	9X4407505A				16,00	500	4000	
	50	9X4507505A				25,10	500	2000	
4,5	30	T	9	2,25	PZ2	9X45307505A	15,40	500	4000
	35	9X45357505A				17,60	500	4000	
	40	9X45407505A				18,00	500	4000	
	45	9X45457505A				19,70	250	2000	
	50	9X45507505A				24,80	250	2000	
	60	9X45607505A				28,50	250	2000	
5	40	T	10	2,5	PZ2	9X5407505A	26,00	500	2000
	50	9X5507505A				31,60	250	2000	
	60	9X5607505A				35,60	250	2000	
	70	9X5707505A				42,20	100	800	
	80	9X5807505A				53,50	100	800	
6	60	T	12	3	PZ3	9X6607505A	51,30	100	800
	80	9X6807505A				80,20	100	800	
	90	9X6907505A				88,00	100	800	

Tapón adhesivo MTAP



Características

- Muy resistente al ser de PVC.
- Diámetro 13 [mm]
- ADAPTABLE. A todos los tornillos de cabeza avellanada.
- DURADERO. No cae, porque se adhiere a la madera o fórmica.
- CÓMODO. Fácil colocación.
- INVISIBLE. No se ve porque entona con cualquier madera o melamina.

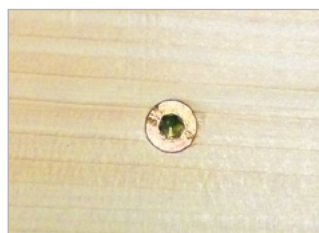

Antes



Después



MTAP Blister		Precios		Envase	Embalaje	
d _s [mm]	Color	Código	Precio €/blister	Envase	Blister x Embalaje	Unid. x Embalaje
13	Blanco liso	51MT	6,40	100	10	1.000
		51MT20	4,40	20	10	200
	Negro	54MT	6,40	100	10	1.000
		54MT20	4,40	20	10	200
	Aluminio	5ALMT	6,40	100	10	1.000
		5ALMT20	4,40	20	10	200
	Beige	5BEMT	6,40	100	10	1.000
		5BEMT20	4,40	20	10	200
	Bobinga	5BOMT	6,40	100	10	1.000
	Cerezo	5CMT	6,40	100	10	1.000
		5CMT20	4,40	20	10	200
	Crema	5CRMT	6,40	100	10	1.000
	Gris	5GRMT	6,40	100	10	1.000
		5GRMT20	4,40	20	10	200
	Haya	5HMT	6,40	100	10	1.000
		5HMT20	4,40	20	10	200
	Maple	5MAMT	6,40	100	10	1.000
		5MAMT20	4,40	20	10	200
	Nogal	5NOMT	6,40	100	10	1.000
		5NOMT20	4,40	20	10	200
Pino	5PIMT	6,40	100	10	1.000	
	5PIMT20	4,40	20	10	200	
Roble claro	5ROMT	6,40	100	10	1.000	
	5ROMT20	4,40	20	10	200	
Roble oscuro	5ROSMT	6,40	100	10	1.000	
Sapeli	5SMT	6,40	100	10	1.000	
	5SMT20	4,40	20	10	200	
Tulipie	5TUMT	6,40	100	10	1.000	
	5WEMT	6,40	100	10	1.000	
Wengue	5WEMT20	4,40	20	10	200	
	Blanco poro	5WPMT	6,40	100	10	1.000
5WPMT20		4,40	20	10	200	

MTAP Caja		Precios		Envase	Embalaje	
d _s [mm]	Color	Código	Precio €/100 u.	Envase	Blister x Embalaje	
13	Blanco	91MT	5,20	1.000	16.000	
	Negro	94MT	5,20	1.000	16.000	
	Aluminio	9ALMT	5,20	1.000	16.000	
	Beige	9BEMT	5,20	1.000	16.000	
	Bobinga	9BOMT	5,20	1.000	16.000	
	Cerezo	9CMT	5,20	1.000	16.000	
	Crema	9CRMT	5,20	1.000	16.000	
	Gris	9GRMT	5,20	1.000	16.000	
	Haya	9HMT	5,20	1.000	16.000	
	Maple	9MAMT	5,20	1.000	16.000	
	Nogal	9NOMT	5,20	1.000	16.000	
	Pino	9PIMT	5,20	1.000	16.000	
	Roble	9ROMT	5,20	1.000	16.000	
	Roble oscuro	9ROSMT	5,20	1.000	16.000	
	Sapeli	9SMT	5,20	1.000	16.000	
	Wengue	9WEMT	5,20	1.000	16.000	
Blanco poro	9WPMT	5,20	1.000	16.000		

Tornillo para madera DM

VELOX® MDF

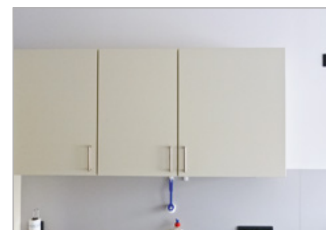

Características

- Especial para maderas MDF/DM.
- Cabeza avellanada con impronta SIT® 20 y estrías. Permite un encaje perfecto para atornillar fácilmente.
- Rápida inserción en la madera.
- Punta broca de 90° que reduce el riesgo a que la madera se agriete.
- La punta broca, realiza un taladro previo al ensamblaje, desplazando la viruta y evitando que la madera se agriete.
- Fácil inicio del taladro en melaminas y superficies duras, taladra incluso chapa o aluminio de 1,5 [mm]
- Punta SIT® incluida en la caja.
- Lubricado.

Otros



Generan grietas.

Velox MDF



Evita que se agriete la madera

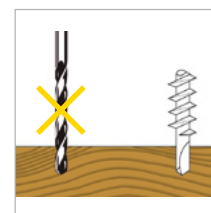

Fácil inicio del taladro. Para evitar un pretaladro en el montaje

VELOX MDF Cincado						Precios		Envase	Embalaje
d _s [mm]	L _s [mm]	L _{th} [mm]	d _h [mm]	H _k [mm]	Impronta	Código	Precio €/100 u.	(Uds)	(Uds)
3,5	50	35	7	2,4	SIT20	93550MDF	10,40	500	4000
4	40	27	8	2,5	SIT20	9440MDF	7,50	500	4000
	45	32				9445MDF	8,90	500	4000
	50	32				9450MDF	9,10	500	4000
	60	35				9460MDF	15,60	500	4000

Tornillo de regulación JS

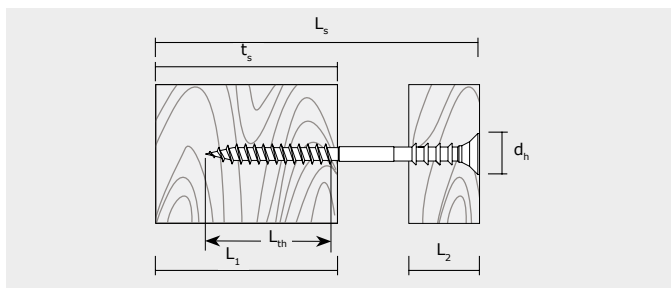

Características

- Tornillo de regulación diseñado para rastrelar paredes, techos o suelos (madera sobre madera).
- Impronta TX25.
- Puede usarse en combinación con tacos: NF, FX, MZ, MZK, etc. .

JS							Precios		Envase	Embalaje
d _s [mm]	L _s [mm]	L _{th} [mm]	d _h [mm]	L ₂ [mm]	t _s [mm]	Impronta	Código	Precio €/100 u.	Envase (Uds)	Embalaje (Uds)
6	60	30	12	20	40	TX25	9660JS	25,60	100	1800
	70	40	12	25	40		9670JS	29,10	100	1800
	80	50	12	25	40		9680JS	38,40	100	1800
	100	50	12	25	40		96100JS	50,30	100	1800

Instalación

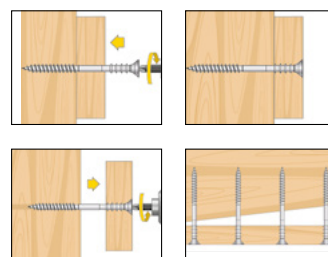

Tornillo métrico tirador TIR

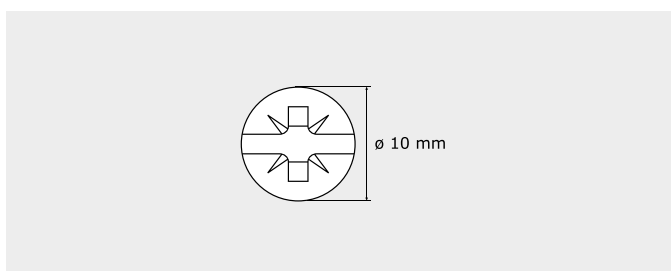

Características

- Cabeza alomada ancha.
- Pozi + ranura.
- Rosca métrica M4.
- Para la sujeción de tiradores y pomos con rosca interior.

TIR Niquelado							Precios		Envase	Embalaje
d _s [mm]	L _s [mm]	L _{th} [mm]	d _s [mm]	H _k [mm]	Impronta	Código	Precio €/100 u.	Envase (Uds)	Embalaje (Uds)	
4	20	T	10	2,6	PZ2 + ranura	9Q420TIR	6,20	500	8000	
	22					9Q422TIR	6,80	500	8000	
	25					9Q425TIR	6,90	500	4000	
	28					9Q428TIR	7,40	500	4000	
	30					9Q430TIR	7,60	500	4000	
	35					9Q435TIR	9,60	250	4000	
	40					9Q440TIR	10,50	250	4000	
	45					9Q445TIR	12,20	250	2000	
	50					9Q450TIR	14,70	250	2000	

T Rosca total

Tornillo métrico cortable

TIRM



Para cortar a medida

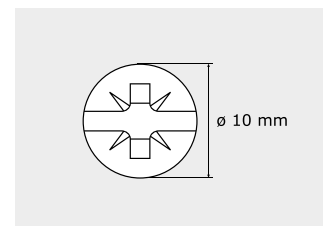

Características

- Cabeza alomada ancha.
- Pozi + ranura.
- Multilargo.
- El diseño del vástago permite adaptar el largo utilizable en cada caso.
- Rosca métrica M4.

TIRM						Precios		Envase	Embalaje
d_s [mm]	L_s [mm]	L_{in} [mm]	d_h [mm]	H_k [mm]	Impronta	Código	Precio €/100 u.	 (Uds)	 (Uds)
4	45	35	10	2,6	Pozi + ranura	9445TIRM	8,30	250	2000
						9B445TIRM	8,30	250	2000
						9Q445TIRM	12,20	250	2000

Tornillo cabeza gota sebo BC



Características

- Cabeza gota de sebo.
- Pozi (PZ2).
- Cabeza diámetro \varnothing 7,5 mm para \varnothing 4 mm y \varnothing 6,5 mm para \varnothing 3,5[mm]
- Rosca madera.
- Para la sujeción de las bisagras de cazoleta en muebles de cocina.

BC Niquelado Caja						Precios		Envase	Embalaje
d_s [mm]	L_s [mm]	L_{in} [mm]	d_h [mm]	H_k [mm]	Impronta	Código	Precio €/caja	 (Uds)	 (Uds)
3,5	15	T	6,7	2,3	PZ2	9Q3515BC	4,60	1000	16000
4	15	T	7,7	2,5	PZ2	9Q415BC	5,20	1000	16000
	17		7,7			9Q417BC	5,50	1000	16000
	20		7,7			9Q420BC	5,80	1000	8000

BC Niquelado Blister			Precios		Embalaje
d_s [mm]	L_s [mm]		Código	Precio €/blister	blister x embalaje
4	15		4Q415BC	6,30	10
3,5	15		7Q3515BC	3,20	10
4	15		7Q415BC	3,20	10

Tornillo cabeza reducida BPL



Características

- Cabeza avellanada.
- Pozi (PZ1).
- Rosca madera 40°.
- Para la sujeción de bisagras de piano y librillo.

BPL Bicromatado						Precios		Envase	Embalaje
d _s [mm]	L _s [mm]	L _{th} [mm]	d _h [mm]	H _k [mm]	Impronta	Código	Precio €/100 u.	(Uds)	(Uds)
3	15	T	4,9	1,3	PZ1	9B315BPL	3,30	1.000	32.000
	17	9B317BPL				3,30	1.000	16.000	
	20	9B320BPL				4,00	1.000	16.000	

T Rosca total

Tornillo cabeza ancha CM



Características

- Cabeza extraplana.
- Pozi (PZ2).
- Rosca madera 40°.
- Para la fijación de tiradores de madera, traseras de armario, capialzados de madera (evita el uso de ovalillos).

CM Bicromatado						Precios		Envase	Embalaje
d _s [mm]	L _s [mm]	L _{th} [mm]	d _h [mm]	H _k [mm]	Impronta	Código	Precio €/100 u.	(Uds)	(Uds)
3	20	T	7,8	1,6	PZ2	9B320CM	4,30	1.000	8.000
	25	9B325CM				4,50	1.000	8.000	
	30	9B330CM				6,40	1.000	8.000	
	35	9B335CM				6,90	500	4.000	
3,5	10	T	8,8	1,6	PZ2	9B3510CM	4,20	1.000	16.000
	15	9B3515CM				4,40	1.000	16.000	
4	17	T	9,8	1,8	PZ2	9B417CM	5,20	1.000	8.000
	20	9B420CM				5,50	1.000	8.000	
	25	9B425CM				6,20	1.000	8.000	
	30	9B430CM				7,30	500	4.000	
	35	9B435CM				8,60	500	4.000	
	40	9B440CM				9,30	500	4.000	
	45	9B445CM				11,70	250	2.000	

T Rosca total

Tornillo ensamblaje ENE



Características

- Impronta allen N°3 para Ø5 mm y N°4 para Ø7 [mm]
- Para ensamblaje.

ENE Cincado						Precios		Envase	Embalaje
d _s [mm]	L _s [mm]	L _{th} [mm]	d _h [mm]	H _k [mm]	Impronta	Código	Precio €/100 u.	 (Uds)	 (Uds)
5	40	27	7,5	10	allen n.3	9540ENE	9,00	250	4.000
	50	37				9550ENE	9,00	250	2.000
7	50	37	10,2	10	allen n.4	9750ENE	14,80	250	2.000

ENE Bicromatado						Precios		Envase	Embalaje
d _s [mm]	L _s [mm]	L _{th} [mm]	d _h [mm]	H _k [mm]	Impronta	Código	Precio €/100 u.	 (Uds)	 (Uds)
5	50	37	7,5	10	allen n.3	9B550ENE	9,00	250	2.000
7			10,2		allen n.4	9B750ENE	14,80	250	2.000

ENE Cincado negro						Precios		Envase	Embalaje
d _s [mm]	L _s [mm]	L _{th} [mm]	d _h [mm]	H _k [mm]	Impronta	Código	Precio €/100 u.	 (Uds)	 (Uds)
5	50	37	7,5	10	allen n.3	9N550ENE	9,20	250	2.000
7			10,2		allen n.4	9N750ENE	15,10	250	2.000

Tornillo doble rosca RA86



Características

- Cabeza redonda.
- Ranurado 3,8 [mm]
- Latonado.
- Para tiradores, bocallaves y escudos.

RA86						Precios		Envase	Embalaje
d _s [mm]	L _s [mm]	L _{th} [mm]	d _h [mm]	H _k [mm]	Impronta	Código	Precio €/100 u.	 (Uds)	 (Uds)
2,1	10	T	3,8	1,4	ranura	9L211086	5,20	1.000	32.000
	13					9L211386	5,20	1.000	32.000
	15					9L211586	5,20	1.000	32.000

T Rosca total

Tornillo cabeza alomada broca aleta **CBTON**

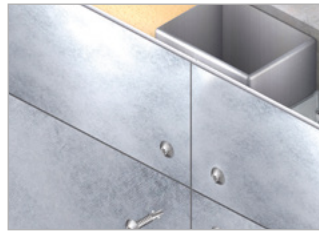

Composite sobre acero

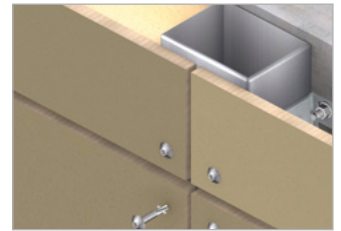

Fibro-cemento sobre acero

Características

- Impronta SIT[®]. Permite un encaje perfecto para atornillar fácilmente.
- Fijación rápida de la placa al perfil en una sola operación.
- Tornillo punta broca con aletas taladra el acero hasta 3 [mm], fijando la placa al perfil.
- Recubrimiento especial láminas Zn-Al garantiza una alta resistencia a la corrosión (480 HNS).
- El tornillo con aletas realiza un agujero sobredimensionado sobre la placa de "composite" o "fibrocemento".
- Este agujero sobredimensionado permite la dilatación de la placa absorbiendo cualquier movimiento.
- Cabeza Ø 12 [mm]

CBTON						Precios		Envase	Embalaje
d _s [mm]	L _s [mm]	L _h [mm]	d _h [mm]	G (espesor) [mm]	Impronta	Código	Precio €/100 u.	Envase (Uds)	Embalaje (Uds)
4,8	32	T	12	2/3	SIT20	9ZG4832CBTON	15,40	250	4.000
	38			-		9ZG4838CBTON	17,00	250	4.000

Maletín tornillería **M1**

Características

- Maletín porta Tornillos.

M1				Precios		Envase	Embalaje
Ref.	Largo	Ancho	Alto	Código	Precio €/u.		
M1	345	245	55	M1	83,40	1	1



345x245x55 [mm]

Tornillo avellanado broca aleta **CBH** / **CBT**

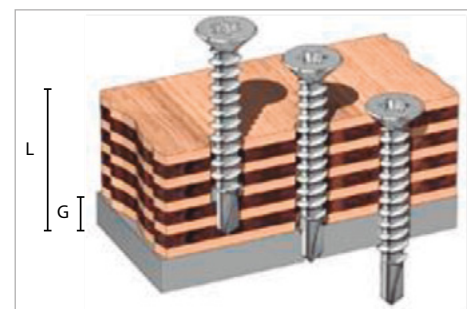
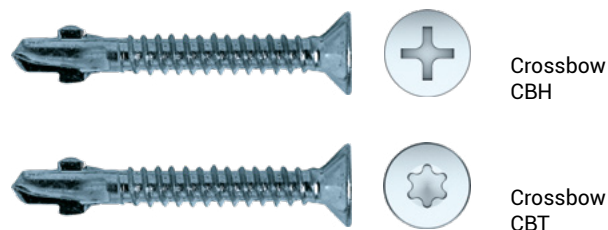

G: Espesor del perfil metálico.C

Características

- H: Philips (PH).
- T: Torx (TX).
- Autotaladrante con aletas.
- Punta taladro reforzada, especialmente diseñada para maderas duras.
- Aletas incorporadas en la broca para mejorar la evacuación de la viruta*.
- Diámetro de núcleo reforzado para evitar rotura del tornillo.

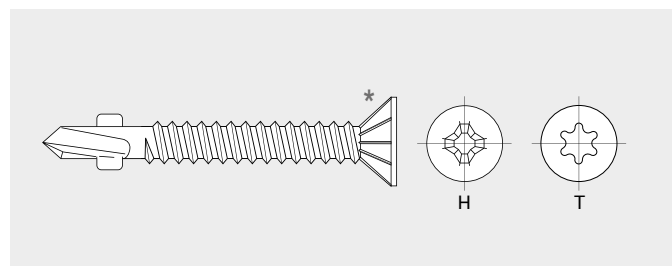

CBH Cincado						Precios		Envase	Embalaje
d_s [mm]	L_s [mm]	L_{th} [mm]	d_{th} [mm]	G (espesor del perfil metálico) [mm]	Impronta	Código	Precio €/100 u.	(Uds)	(Uds)
4,2	32	T	8,10	2/3	2	94232CBH	9,30	250	4.000
4,8	32	T	9,5	2/3	2	94832CBH	12,00	250	4.000
	38					94838CBH	13,10	500	4.000
5,5	38	T	10,8	2,5/3,5	3	95538CBH	18,40	250	2.000
	50					95550CBH	21,80	250	2.000
	55					95555CBH	24,40	250	2.000
	60					95560CBH	26,40	100	800

CBT Cincado						Precios		Envase	Embalaje
d_s [mm]	L_s [mm]	L_{th} [mm]	d_{th} [mm]	G (espesor del perfil metálico) [mm]	Impronta TX	Código	Precio €/100 u.	(Uds)	(Uds)
4,8	32	T	9,5	2/3	25	94832CBT	13,10	250	4.000
	38					94838CBT	13,80	250	2.000
	45					94845CBT	15,30	250	2.000
5,5	38	T	10,8	2,5/3,5	30	95538CBT	19,80	250	2.000
6,3	55	T	12,4	3,5	30	96355CBT	31,60	200	1.600
	65					96365CBT	35,00	100	800
	75					96375CBT	37,50	100	800
	85					96385CBT	47,10	50	400

Tornillo para fenólico

FEC / FEP

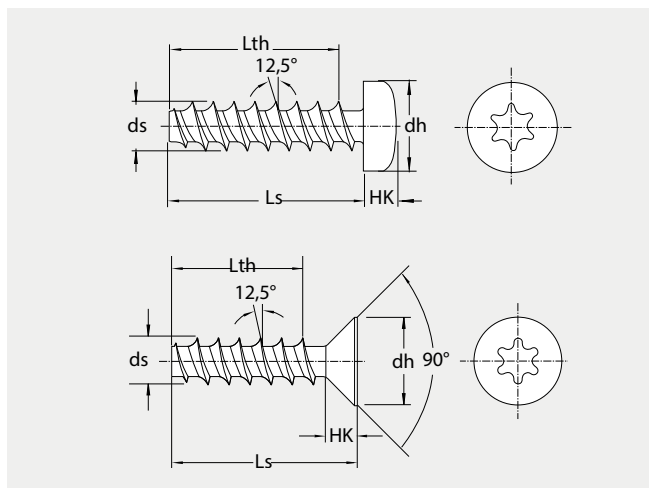

Características

- Cabeza avellanada y cabeza alomada.
- Impronta TORX®.
- Sin punta.
- Rosca especial para composite.

Ventajas

- Tornillo sin punta, no pierde longitud de engarce y rosca en toda su extensión.
- Esta rosca no rompe el material base ya que su filete le permite cortar el material sin dañarlo.

FEC Cincado							Precios		Envase	Embalaje
d_s [mm]	l_s [mm]	L_{th} [mm]	d_h [mm]	H_k [mm]	Impronta	Código	Precio €/100 u.	(Uds)	(Uds)	
4	8	5,7	7,0	2,3	TX20	948FEC	5,90	500	16.000	
4	10	7,7	7,0	2,3	TX20	9410FEC	6,30	500	16.000	

FEC Inoxidable A2							Precios		Envase	Embalaje
d_s [mm]	l_s [mm]	L_{th} [mm]	d_h [mm]	H_k [mm]	Impronta	Código	Precio €/100 u.	(Uds)	(Uds)	
4	8	5,7	7,0	2,3	TX20	9X48FEC	12,30	500	16.000	
4	10	7,7	7,0	2,3	TX20	9X410FEC	13,00	500	16.000	

FEP Cincado							Precios		Envase	Embalaje
d_s [mm]	l_s [mm]	L_{th} [mm]	d_h [mm]	H_k [mm]	Impronta	Código	Precio €/100 u.	(Uds)	(Uds)	
4	8	8	7,5	2,3	TX20	948FEP	5,80	500	16.000	
4	10	10	7,5	2,8	TX20	9410FEP	6,20	500	16.000	

FEP Inoxidable A2							Precios		Envase	Embalaje
d_s [mm]	l_s [mm]	L_{th} [mm]	d_h [mm]	H_k [mm]	Impronta	Código	Precio €/100 u.	(Uds)	(Uds)	
4	8	8	7,0	2,6	TX15	9X48FEP	12,10	500	16.000	
4	10	10	7,0	2,6	TX15	9X410FEP	12,80	500	16.000	

Tornillo de construcción

BMax

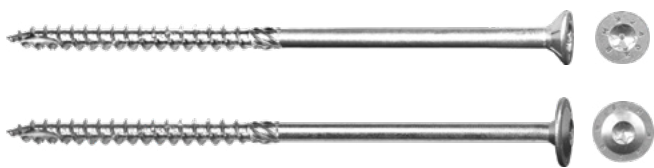

Características

- Óptimo enrasado gracias a las estrías externas bajo la cabeza.
- Punta kerb para inserción rápida.
- Rosca rápida reduce el par de roscado e incrementa la vida útil de la batería (especialmente en tornillos largos).
- Tornillo de cabeza alomada con arandela estampada para una mayor área de contacto.

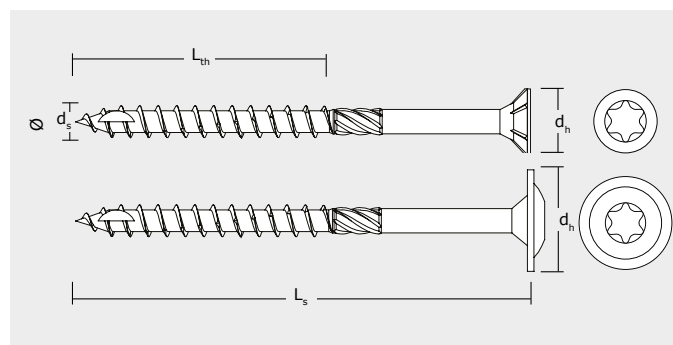

d_s : Diámetro tornillo L_{th} : Parte roscada.
 L_s : Longitud tornillo. d_h : Diámetro cabeza.

BMax Cabeza avellanada					Precios		Envase	Embalaje
d_s [mm]	L_s [mm]	L_{th} [mm]	d_h [mm]	Impronta	Código	Precio €/100 u.	 (Uds)	 (Uds)
6	60	52	12	TX 30	9660BMP*	19,00	100	1600
					9680BMP	24,90	100	1600
	100	75			96100BMP	30,70	100	1200
					96120BMP	40,20	100	1200
	140				96140BMP	53,10	100	800
					96160BMP	68,50	100	800
	180				96180BMP	84,90	100	800
					96200BMP	99,00	100	800
	220				96220BMP	117,90	100	800
					96240BMP	133,20	100	600
	260				96260BMP	149,10	100	600
					96280BMP	165,10	100	600
	300				96300BMP	181,20	100	600
8	80	52	15	TX 40	9880BMP	31,70	50	800
					98100BMP	38,50	50	800
	120	80			98120BMP	47,60	50	600
					98140BMP	56,50	50	600
	160				98160BMP	72,40	50	400
					98180BMP	90,80	50	400
	200				98200BMP	108,00	50	400
					98220BMP	125,90	50	400
	240				98240BMP	151,30	50	300
					98260BMP	171,80	50	300
	280				98280BMP	189,90	50	300
					98300BMP	203,80	50	300
	320				98320BMP	221,90	50	300
					98340BMP	241,10	50	300
360				98360BMP	264,40	50	200	
				98380BMP	296,40	50	200	
400				98400BMP	326,20	50	200	
10	80	52	18,5	TX 50	91080BMP	42,50	50	800
					910100BMP	50,90	50	800
	120	80			910120BMP	63,80	50	600
					910140BMP	80,00	50	600
	160				910160BMP	98,40	50	400
					910180BMP	123,50	50	400
	200				910200BMP	148,60	50	400
					910220BMP	177,60	50	400
	240				910240BMP	208,40	50	300
					910260BMP	231,40	50	300
	280				910280BMP	260,50	50	300
					910300BMP	289,30	50	300
	320				910320BMP	318,30	50	300
					910340BMP	343,50	50	300
360				910360BMP	372,30	50	200	
				910380BMP	420,60	50	200	
400				910400BMP	453,30	50	200	



BMax cabeza alomada y arandela estampada					Precios		Envase	Embalaje
d _s [mm]	L _s [mm]	L _{th} [mm]	d _h [mm]	Impronta	Código	Precio €/100 u.	(Uds)	(Uds)
8	80	52	22	TX 40	9880BMLP	36,70	50	800
	100				98100BMLP	42,90	50	600
	120				98120BMLP	54,20	50	600
	140	80	98140BMLP		63,80	50	400	
	160		98160BMLP		79,10	50	400	
	180	100	98180BMLP		102,40	50	400	
	200		98200BMLP		113,90	50	400	
	220		98220BMLP		140,90	50	400	
	240		98240BMLP		171,80	50	300	
	260	25	98260BMLP		196,70	50	300	
	280		98280BMLP		216,00	50	300	
	300		98300BMLP		237,30	50	300	
	320		98320BMLP		262,50	50	300	
	340		98340BMLP		285,60	50	200	
	360		98360BMLP		304,90	50	200	
	380		98380BMLP		347,30	50	200	
400	98400BMLP		376,20	50	200			
10	80	52	25	91080BMLP	50,20	50	600	
	100			910100BMLP	56,60	50	400	
	120			910120BMLP	65,30	50	400	
	140	80	910140BMLP	91,70	50	400		
	160		910160BMLP	111,90	50	400		
	180	100	910180BMLP	139,00	50	300		
	200		910200BMLP	169,80	50	300		
	220		910220BMLP	196,70	50	300		
	240		910240BMLP	235,30	50	300		
	260	25	910260BMLP	262,50	50	300		
	280		910280BMLP	289,30	50	300		
	300		910300BMLP	318,30	50	200		
	320		910320BMLP	360,80	50	200		
	340		910340BMLP	387,70	50	50		
	360		910360BMLP	418,70	50	50		
	380		910380BMLP	472,70	50	50		
400	910400BMLP		515,10	50	50			

Tirafondo con arandela **FTX71**

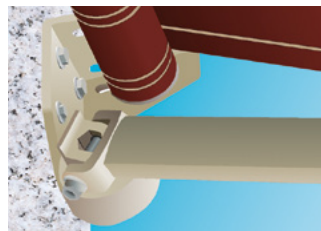

Características

- Cabeza hexagonal con arandela imperdible.
- Rosca tirafondo.
- Mayor longitud de rosca.
- Para la fijación de soportes en fachadas, toldos, aire acondicionado, letreros luminosos, etc....
- Diámetro de 6 para taco de 8 y de 8 para taco de 10.
- La arandela imperdible permite una mejor adaptación de la fijación a la pared.
- La mayor longitud de rosca permite una mayor expansión del taco, evitando el pasado de rosca.

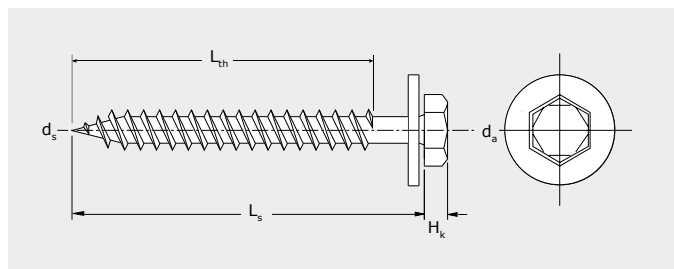

d_s : Diámetro tornillo L_{th} : Parte roscada. H_k : Altura de cabeza.
 L_s : Longitud tornillo. d_h : Diámetro cabeza. d_a : Diámetro exterior.

FTX71						Precios		Envase	Embalaje
d_s [mm]	L_s [mm]	L_{th} [mm]	d_a [mm]	hk [mm]	Impronta	Código	Precio €/100 u.	(Uds)	(Uds)
6	50	T	18	4,38	SW10	9650FTX71	32,30	250	2000
	60					9660FTX71	35,40	250	2000
	70					9670FTX71	40,00	250	1000
8	60	T	24	5,88	SW13	9860FTX71	64,50	100	1000
	80					9880FTX71	75,20	100	1000

Tornillo tirafondo DIN 571

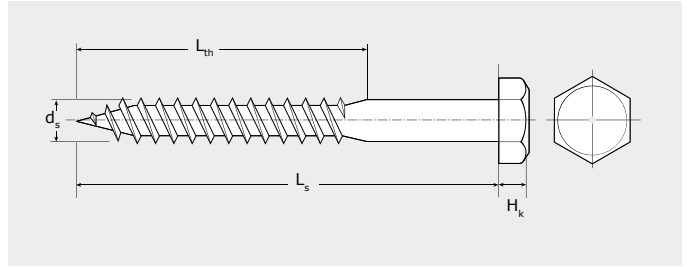

d_s : Diámetro tornillo L_{th} : Parte roscada. H_k : Altura de cabeza.
 L_s : Longitud tornillo. d_h : Diámetro cabeza.

Características

- Cabeza hexagonal.
- Rosca tirafondo.

DIN 571 Cincado					Precios		Envase	Embalaje	
d_s [mm]	L_s [mm]	L_{th} [mm]	H_k [mm]	Impronta	Código	Precio €/100 u.	(Uds)	(Uds)	
5	35	21	3,5	SW8	9535571	7,20	250	4000	
	40	24			9540571	7,40	250	4000	
	50	30			9550571	8,00	250	2000	
	6	30			18	4	SW10	9630571	7,50
40	24	9640571	9,40	250	2000				
			9640571125	9,00	125			1000	
	45	27	9645571	10,40	250			2000	
	50	30	9650571	11,30	250			2000	
			9650571100	12,80	100			1600	
	60	36	9660571	13,30	100			800	
			966057175	14,30	75			1200	
	70	42	9670571	14,10	100			800	
			967057150	15,50	50			800	
	80	48	9680571	15,10	100	800			
	100	60	96100571	20,70	200	800			
7	40	24	5	SW12	9740571	15,10	250	2000	
	50	30			9750571	17,00	250	1000	
	60	36			9760571	18,70	250	1000	
	70	42			9770571	20,70	250	1000	
	80	48			9780571	25,40	100	800	
8	40	24	5,5	SW13	9840571	18,70	250	2000	
	45	27			9845571	19,80	250	1000	
	50	30			9850571	20,70	250	1000	
	60	36			9860571	21,60	250	1000	
						986057175	23,90	75	1200
		70			42	9870571	25,40	100	800
						987057150	27,70	50	800
		80			48	9880571	28,10	100	800
						988057130	31,00	30	480
		90			54	9890571	31,90	100	800
		100			60	98100571	33,00	100	400
		120			72	98120571	36,50	100	400
	140	84	98140571	47,00	50	200			
	150	90	98150571	56,20	100	200			
10	50	30	7	SW17	91050571	35,20	200	800	
	60	36			91060571	35,60	100	400	
	70	42			91070571	37,60	100	400	
	80	48			91080571	43,10	100	400	
	90	54			91090571	49,50	100	400	
	100	60			910100571	50,70	100	400	
	120	72			910120571	63,70	50	200	
	140	84			910140571	75,00	50	200	
	160	96			910160571	95,70	50	200	
	180	108			910180571	116,30	50	200	

Blister

DIN 571 Cincado					Precios		Envase	Embalaje	
d_s [mm]	L_s [mm]	L_{th} [mm]	H_k [mm]	Impronta	Código	Precio €/100 u.	unid. x blister	blister x embalaje	unid. x embalaje
5	40	24	3,5	SW8	7540571	3,20	10	10	100
	40				4540571	6,30	40	10	400
	50	30			7550571	3,20	10	10	100
	50				4550571	6,30	50	10	500
6	40	24	4	SW10	7640571	3,20	10	10	100
	40				6440571	6,30	50	10	500
	50	30			7650571	3,20	10	10	100
	50				6650571	6,30	40	10	400
	60	36			7660571	3,20	10	10	100
	60				4660571	6,30	30	10	300
7	50	30	5	SW12	7750571	3,20	6	10	60
	50				4750571	6,30	25	10	250
	60	36			7760571	3,20	6	10	60
	60				4760571	6,30	20	10	200
	70	42			7770571	3,20	4	10	40
	70				4770571	6,30	20	10	200
	80	48			7780571	3,20	4	10	40
	80				4780571	6,30	20	10	200
8	50	30	5,5	SW13	7850571	3,20	4	10	40
	50				4850571	6,30	20		
	60	36			7860571	3,20	4	10	40
	60				4860571	6,30	20		
	70	42			7870571	3,20	4	10	40
	70				4870571	6,30	15		
	80	48			7880571	3,20	4	10	40
	80				4880571	6,30	15		
	90	54			7890571	3,20	4	10	40
	100	60			78100571	3,20	4	10	40
10	70	42	7	SW17	71070571	3,20	2	10	20
	70				41070571	6,30			
	90	54			71090571	3,20	2	10	20
	80				41080571	6,30			
	100	60			710100571	3,20	2	10	20

Tornillo inox cabeza botón

BTW



Características

- Cabeza botón.
- Inoxidable A2.
- Rosca madera.
- Impronta TORX (TX).
- Cabeza ancha ($\varnothing 10$ para tornillo $\varnothing 4,5$ mm y $\varnothing 12$ para tornillo $\varnothing 5$ mm). Parte no roscada para absorber la dilatación de la placa.
- Para fijación en fachadas de placas composite y fibrocemento sobre perfiles de madera. ($\varnothing 5$ y $\varnothing 4,5$).
- Tornillo para taco. Inoxidable A2. Cabeza ancha ($\varnothing 17$ mm).
- Fijación de soportes exteriores, rejas, barandillas, mobiliario urbano, con taco nylon FX 10 ($\varnothing 7$)



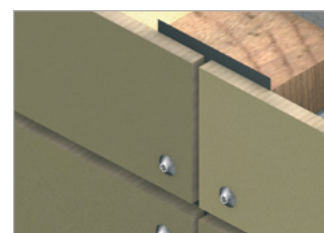

Composite sobre madera



Fibrocemento sobre madera



Fijación con taco

BTW						Precios		Envase	Embalaje
d_s [mm]	L_s [mm]	L_h [mm]	d_h [mm]	H_k [mm]	Impronta	Código	Precio €/100 u.	 (Uds)	 (Uds)
4,5	30	23	10	2,45	TX20	9X4530BTW	24,90	500	4000
	40	33				9X4540BTW	29,80	500	4000
5	40	30	12	2,9	TX20	9X540BTW	39,60	500	4000
	45	35				9X545BTW	46,30	250	2000
	60	50				9X560BTW	54,70	250	2000
7	50	T	17	3,7	TX30	9X750BTW	90,90	100	800
	60	54				9X760BTW	107,50	100	800
	70	54				9X770BTW	140,50	100	800

Tornillo inviolable TIC

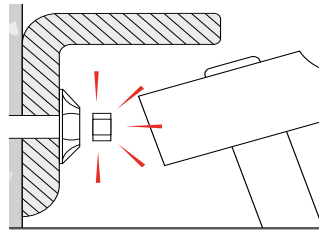

El tapón de Zamac hace indesmontable el tornillo

Características

- Cabeza embellecedora.
- Rosca especial para madera y tacos ($\varnothing 6$ para FX8 y $\varnothing 7$ para FX10).
- Incluye tapón de zamac del mismo color que el tornillo.
- Acero más resistente que en modelos parecidos.

TIC Cincado						Precios		Envase	Embalaje
d_s [mm]	L_s [mm]	L_{th} [mm]	d_h [mm]	H_k [mm]	Impronta	Código	Precio €/100 u.	(Uds)	(Uds)
6	40	32	13,5	3,6	TX30	9640TIC	24,30	250	2000
	50	32				9650TIC	25,80	100	800
	60	44				9660TIC	27,50	100	800
	70	44				9670TIC	31,30	100	800
	7	40				29	16,5	4,35	TX30
50	29	9750TIC	25,10	100	800				
60	29	9760TIC	28,10	100	800				
70	60	9770TIC	29,80	100	800				
85	60	9785TIC	32,80	50	400				
	105	60				97105TIC	47,70	50	400

TIC Cincado Negro						Precios		Envase	Embalaje
d_s [mm]	L_s [mm]	L_{th} [mm]	d_h [mm]	H_k [mm]	Impronta	Código	Precio €/100 u.	(Uds)	(Uds)
6	40	32	13,5	3,6	TX30	9N640TIC	31,30	250	2000
	50	32				9N650TIC	32,20	100	800
	60	44				9N660TIC	35,20	100	800
	70	44				9N670TIC	39,00	100	800
	7	40				29	16,5	4,35	TX30
50	29	9N750TIC	42,20	100	800				
60	29	9N760TIC	46,80	100	800				
70	60	9N770TIC	50,00	100	800				
85	60	9N785TIC	57,80	50	400				

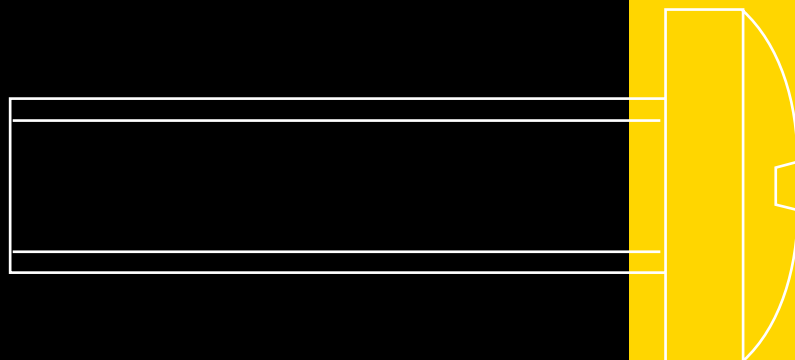

Tornillos rosca métrica, tuercas y arandelas

Tornillo alomado DIN 7985	302
Tornillo TORX alomado 7985 TX	303
Tornillo DIN 965	304
Tornillo DIN 966	305
Tornillo DIN 84	306
Tornillo DIN 85	307
Tornillo DIN 963	308
Tornillo DIN 933	309
Tornillo estantería E2/E4	310
Tuerca imperdible COMBY	310

Tuerca DIN 934	311
Tuerca DIN 439	312
Tuerca autoblocante DIN 985 / DIN 6923	312
Tuerca de neopreno CFLEX	313
Arandela EPDM 7711 / EPDM 7712	314
Arandela gower DIN 7980 / DIN 127B	314
Arandela DIN125A / DIN 9021	315
Arandela dentada DIN 6798J ADI / DIN 6798A ADE	316

Tornillo DIN 7985

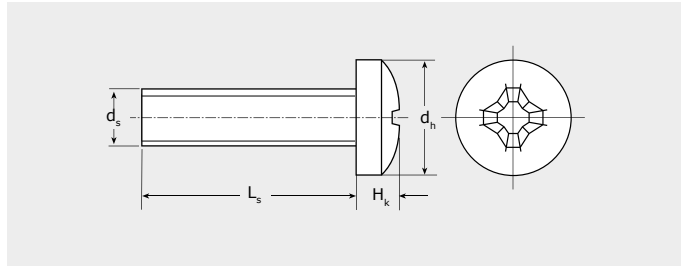
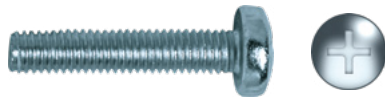

d_s : Diámetro tornillo L_{th} : Parte roscada. H_k : Altura de cabeza.
 L_s : Longitud tornillo. d_h : Diámetro cabeza.

Características

- Cabeza alomada.
- Philips (PH).

Cajas

DIN 7985 Cincado						Precios		Envase	Embalaje
d_s [mm]	L_s [mm]	L_{th} [mm]	d_h [mm]	H_k [mm]	Impronta	Código	Precio €/100 u.	(Uds)	(Uds)
3	6	T	6	2,4	PH1	9367985	2,40	1000	32000
	7					9377985	2,50	1000	32000
	8					9387985	2,50	1000	32000
	10					93107985	2,50	1000	16000
	12					93127985	2,60	1000	16000
	16					93167985	3,00	1000	16000
20					93207985	3,40	1000	16000	
4	6	T	8	3,1	PH2	9467985	3,70	500	16000
	8					9487985	3,70	500	16000
	10					94107985	4,10	500	16000
	12					94127985	4,20	500	8000
	15					94157985	4,40	500	8000
	20					94207985	4,70	500	8000
	25					94257985	5,40	500	4000
	30					94307985	6,50	500	4000
40					94407985	8,80	250	4000	
5	10	T	10	3,8	PH2	95107985	5,80	500	8000
	15					95157985	6,60	250	8000
	20					95207985	7,60	250	4000
	25					95257985	8,80	250	4000
	30					95307985	9,60	250	4000
	40					95407985	11,70	150	2400
50					95507985	15,70	125	2000	
6	8	T	12	4,6	PH3	9687985	8,90	250	8000
	10					96107985	8,90	250	4000
	15					96157985	9,70	250	4000
	20					96207985	11,10	250	4000
	25					96257985	12,30	250	4000
	30					96307985	13,20	200	3200
40					96407985	16,20	150	2400	
50					96507985	20,20	100	1600	



T Rosca total

Bolsas

DIN 7985 Cincado						Precios		Envase	Embalaje
d_s [mm]	L_s [mm]	L_{th} [mm]	d_h [mm]	H_k [mm]	Impronta	Código	Precio €/bolsa	(Uds)	(Uds)
2	5	T	4	1,6	PH1	257985	4,20	-	5000
2,5	5	T	5	2	PH1	2557985	3,10	-	5000
2,6	6	T	5	2,1		2667985	3,10	-	5000
3	4	T	6	2,4	PH1	347985	3,20	-	5000
	5					357985	2,50	-	5000
	7					377985	2,50	-	5000
	8					387985	2,50	-	5000
	18					3187985	3,10	-	2500
	20					3207985	3,50	-	2500
25					3257985	3,70	-	1250	
30					3307985	4,50	-	1250	
4	5	T	8	3,1	PH2	457985	4,30	-	2500
	6					467985	3,70	-	2500
	8					487985	3,90	-	2500
	10					4107985	4,20	-	2500
	15					4157985	4,40	-	1250
	18					4187985	4,50	-	1250
50					4507985	11,30	-	500	
5	6	T	10	3,8	PH2	567985	5,60	-	1250
	8					587985	5,60	-	1250
	10					5107985	5,90	-	1250
	12					5127985	6,20	-	1250
	35					5357985	10,50	-	500
6	12	T	12	4,6	PH3	6127985	9,00	-	500

DIN 7985 Cincado negro						Precios		Envase	Embalaje
d_s [mm]	L_s [mm]	L_{th} [mm]	d_h [mm]	H_k [mm]	Impronta	Código	Precio €/bolsa	(Uds)	(Uds)
3	6	T	6	2,4	PH1	N367985	3,20	-	5000
	10					N3107985	3,50	-	5000

Blister

DIN 7985 Cincado						Precios		Envase	Embalaje	
d _s [mm]	L _s [mm]	L _{th} [mm]	d _h [mm]	H _k [mm]	Impronta	Código	Precio €/blister	 (Uds)	 (Uds)	 (Uds)
3	10	T	6	2,4	PH1	73107985	3,20	30	10	300
	10					43107985	6,30	150	10	1.500
	16					43167985	6,30	140	10	1.400
	20					43207985	6,30	110	10	1.100
4	10	T	8	3,1	PH2	74107985	3,20	20	10	200
	10					44107985	6,30	100	10	1.000
	15					74157985	3,20	20	10	200
	15					44157985	6,30	90	10	900
	20					74207985	3,20	15	10	150
	25					74257985	3,20	15	10	150
	30					74307985	3,20	10	10	100
	30					44307985	6,30	60	10	600
5	10	T	10	3,8	PH2	75107985	3,20	15	10	150
	10					45107985	6,30	80	10	800
	15					75157985	3,20	15	10	150
	15					45157985	6,30	65	10	650
	20					75207985	3,20	10	10	100
	25					75257985	3,20	10	10	100
	25					45257985	6,30	55	10	550
	30					75307985	3,20	8	10	80
6	10	T	12	4,6	PH3	76107985	3,20	10	10	100
	10					46107985	6,30	60	10	600
	15					76157985	3,20	10	10	100
	15					46157985	6,30	50	10	500
	20					76207985	3,20	10	10	100
	20					46207985	6,30	50	10	500
	25					76257985	3,20	10	10	100
	25					46257985	6,30	40	10	400
30					76307985	3,20	6	10	60	
30					46307985	6,30	30	10	300	
40					76407985	3,20	6	10	60	

Tornillo TORX alomado

7985 TX

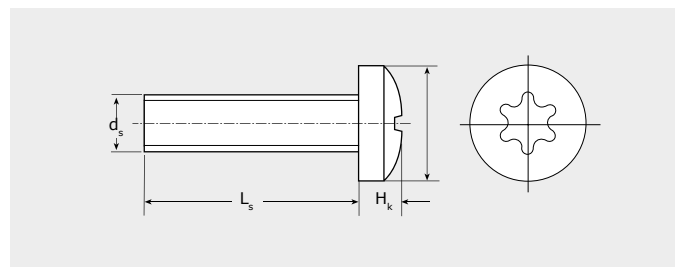



d_s : Diámetro tornillo L_{th} : Parte roscada. H_k : Altura de cabeza.
 L_s : Longitud tornillo. d_h : Diámetro cabeza.

Características

- Cabeza alomada.
- Torx®
- Clase 8.8.

Bolsas

DIN 7985 TX Cincado						Precios		Envase	Embalaje	
d _s [mm]	L _s [mm]	L _{th} [mm]	d _h [mm]	H _k [mm]	Impronta	Código	Precio €/bolsa	 (Uds)	 (Uds)	
5	16	T	10	3,8	T25	5167985T88	10,90	-	1250	
6	12	T	12	4,6	T30	6127985T88	14,10	-	1000	
	16					6167985T88	16,00	-	1000	

Tornillo DIN 965

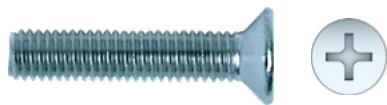

Características

- Cabeza avellanada.
- Impronta Philips (PH).

Cajas

DIN 965 Cincado						Precios		Envase	Embalaje
d_s [mm]	L_s [mm]	L_{th} [mm]	d_h [mm]	H_k [mm]	Impronta	Código	Precio €/100 u.	(Uds)	(Uds)
3	10	T	5,6	1,65	PH1	9310965	2,40	1000	32.000
	15	9315965				2,60	1000	16.000	
	20	9320965				3,20	1000	16.000	
4	8	T	7,5	2,2	PH2	948965	3,20	500	16.000
	10	9410965				3,30	500	16.000	
	15	9415965				3,60	500	8.000	
	20	9420965				4,20	500	8.000	
	25	9425965				4,60	500	4.000	
	30	9430965				6,10	500	4.000	
5	40					9440965	7,50	250	4.000
	10	T	9,2	2,5	PH2	9510965	5,00	250	8.000
	15	9515965				5,70	250	4.000	
	20	9520965				6,40	250	4.000	
	25	9525965				7,30	250	4.000	
	30	9530965				8,10	250	4.000	
	35	9535965				9,20	250	4.000	
	40	9540965				10,10	250	2.000	
50	9550965	14,60				250	2.000		
6	60					9560965	18,40	250	2.000
	10	T	11	3	PH3	9610965	7,50	250	8.000
	12	9612965				7,60	250	4.000	
	15	9615965				8,10	250	4.000	
	20	9620965				9,50	250	4.000	
	25	9625965				10,50	250	4.000	
	30	9630965				11,70	250	4.000	
	35	9635965				13,00	250	2.000	
	40	9640965				14,30	250	2.000	
	50	9650965				19,30	250	2.000	
60	9660965	20,70				100	800		

T Rosca total

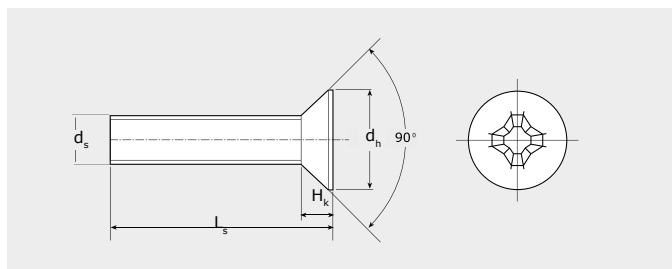

d_s : Diámetro tornillo L_{th} : Parte roscada. H_k : Altura de cabeza.
 L_s : Longitud tornillo. d_h : Diámetro cabeza.

Bolsas

DIN 965 Cincado						Precios		Envase	Embalaje
d_s [mm]	L_s [mm]	L_{th} [mm]	d_h [mm]	H_k [mm]	Impronta	Código	Precio €/bolsa	(Uds)	(Uds)
3	5	T	5,6	1,65	PH1	35965	2,20	5000	35.000
	6	36965				2,10	5000	35.000	
	8	38965				2,20	5000	5.000	
	12	312965				2,40	5000	20.000	
4	8	T	7,5	2,2	PH2	48965	3,20	2500	2.500
	12	412965				3,40	2500	2.500	

DIN 965 Niquelado						Precios		Envase	Embalaje
d_s [mm]	L_s [mm]	L_{th} [mm]	d_h [mm]	H_k [mm]	Impronta	Código	Precio €/bolsa	(Uds)	(Uds)
4	8	T	7,5	2,2	PH2	Q48965	4,30	2500	2.500

Tornillo DIN 966

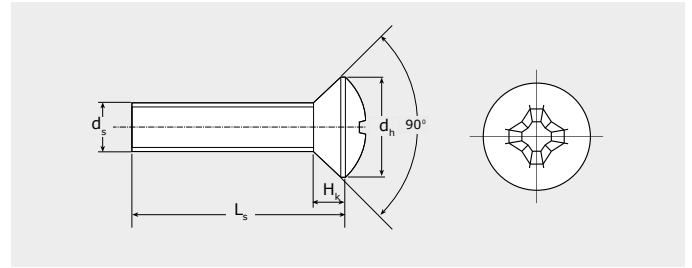
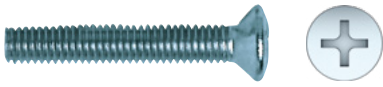

Características

- Cabeza gota sebo.
- Impronta Philips (PH).

d_s : Diámetro tornillo H_k : Altura de cabeza.
 L_s : Longitud tornillo. d_h : Diámetro cabeza.

Bolsas

DIN 966 Cincado						Precios		Envase	Embalaje
d_s [mm]	L_s [mm]	L_{th} [mm]	d_h [mm]	H_k [mm]	Impronta	Código	Precio €/bolsa	(Uds)	(Uds)
3	12	T	5,6	1,65	PH1	312966	2,40	-	5000
4	8	T	7,5	2,2	PH2	48966	3,20	-	2500
	10					410966	3,20	-	2500
	12					412966	3,40	-	2500
	15					415966	3,60	-	2500
	20					420966	4,10	-	1250
5	10	T	9,2	2,5	PH2	510966	4,70	-	1250
	15					515966	5,60	-	1250
6	20	T	11	3	PH3	620966	9,20	-	500
	25					625966	10,10	-	500
	30					630966	11,40	-	500

T Rosca total

Tornillo DIN 84

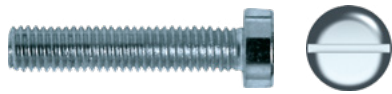

Cincado



Características

- Cabeza cilíndrica.
- Impronta ranura.

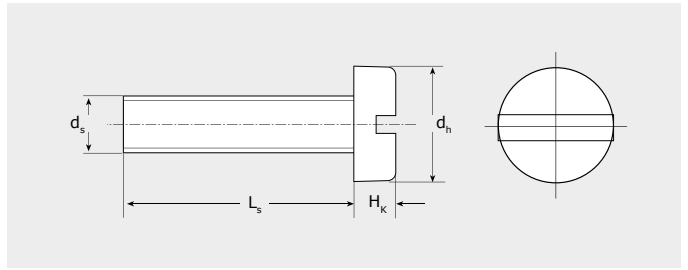

d_s : Diámetro tornillo L_{th} : Parte roscada. H_k : Altura de cabeza.
 L_s : Longitud tornillo. d_h : Diámetro cabeza.

Cajas

DIN 84 Cincado						Precios		Envase	Embalaje
d_s [mm]	L_s [mm]	L_{th} [mm]	d_h [mm]	H_k [mm]	Impronta	Código	Precio €/100 u.	(Uds)	(Uds)
3	5	T	5,5	2	P3	93584	2,60	1000	32000
	6					93684	2,60	1000	32000
	7					93784	2,60	1000	32000
	8					93884	2,60	1000	32000
	10					931084	2,80	1000	32000
	12					931284	3,10	1000	16000
	20					932084	4,10	1000	16000
	25					932584	4,40	1000	8000
	30					933084	5,20	500	8000
	35					933584	7,00	500	8000
4	6	T	7	2,6	P4	94684	3,90	500	16000
	7					94784	3,90	500	16000
	8					94884	3,90	500	16000
	10					941084	4,20	500	16000
	12					941284	4,30	500	16000
	16					941684	4,60	500	8000
	20					942084	5,20	500	8000
	25					942584	5,70	500	8000
	30					943084	7,00	500	4000
	40					944084	9,40	250	4000
45					944584	10,60	250	4000	
50					945084	13,10	250	2000	
5	6	T	8,5	3,3	P5	95684	6,10	500	16000
	8					95884	5,70	500	8000
	10					951084	5,90	500	8000
	16					951684	7,50	250	8000
	20					952084	8,00	250	4000
	25					952584	8,50	250	4000
	30					953084	10,60	250	4000
	40					954084	12,30	250	2000
50					955084	16,90	250	2000	
60					956084	20,10	250	2000	
6	8	T	10	3,9	P6	96884	10,10	250	8000
	10					961084	8,90	250	8000
	12					961284	9,40	250	4000
	16					961684	10,00	250	4000
	20					962084	11,10	250	4000
	25					962584	12,80	250	4000
	30					963084	14,20	250	4000
	40					964084	16,80	250	2000
	50					965084	20,60	250	2000
	60					966084	25,40	100	800

T Rosca total

Bolsas

DIN 84 Cincado						Precios		Envase	Embalaje
d_s [mm]	L_s [mm]	L_{th} [mm]	d_h [mm]	H_k [mm]	Impronta	Código	Precio €/bolsa	(Uds)	(Uds)
2	3	T	3,8	1,3	P2	2384	4,20	-	5000
	6					2684	3,50	-	5000
	8					2884	3,50	-	5000
	10					21084	3,60	-	5000
2,5	5	T	4,5	1,6	P3	25584	3,40	-	5000
	6					25684	3,40	-	5000
	8					25884	3,40	-	5000
	10					251084	3,40	-	5000
2,6	4	T	5	1,7	P3	26484	3,50	-	5000
	5					26584	3,40	-	5000
	7					26784	3,40	-	5000
	12					261284	3,40	-	5000
3	4	T	5,5	2	P3	3484	3,10	-	5000
	15					31584	3,20	-	2500
3,5	5	T	6	2,4	P3	35584	3,90	-	5000
4	5	T	7	2,6	P4	4584	4,70	-	2500
	15					41584	4,50	-	1250

T Rosca total

Blister

DIN 84 Cincado						Precios		Envase	Embalaje
d_s [mm]	L_s [mm]	L_{th} [mm]	d_h [mm]	H_k [mm]	Impronta	Código	Precio €/blister	(Uds)	(Uds)
3	10	T	5,5	2	P3	731084	3,20	30	10 300
	16					731684	3,20	30	10 300
	20					732084	3,20	20	10 200
	25					732584	3,20	20	10 200
4	10	T	7	2,6	P4	741084	3,20	20	10 200
	16					741684	3,20	20	10 200
	20					742084	3,20	15	10 150
	25					742584	3,20	15	10 150
	30					743084	3,20	10	10 100
5	10	T	8,5	3,3	P5	751084	3,20	15	10 150
	16					751684	3,20	15	10 150
	20					752084	3,20	10	10 100
	25					752584	3,20	10	10 100
	30					753084	3,20	8	10 80
40					754084	3,20	6	10 60	
6	10	T	10	3,9	P6	761084	3,20	10	10 100
	16					761684	3,20	10	10 100
	20					762084	3,20	10	10 100
	25					762584	3,20	10	10 100
	30					763084	3,20	6	10 60
	40					764084	3,20	6	10 60
50					765084	3,20	6	10 60	

T Rosca total

Tornillo DIN 85



Cincado

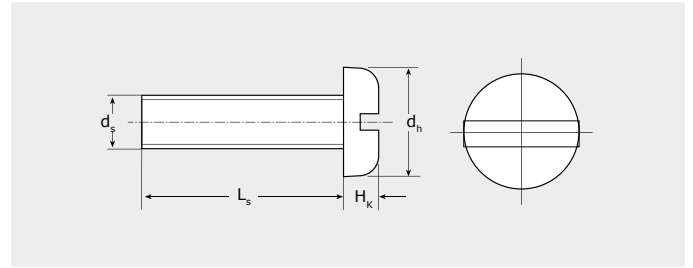

d_s : Diámetro tornillo L_{th} : Parte roscada. H_k : Altura de cabeza.
 L_s : Longitud tornillo. d_h : Diámetro cabeza.

Características

- Cabeza alomada.
- Impronta ranura.

Bolsas

DIN 85						Precios		Envase	Embalaje
d_s [mm]	L_s [mm]	L_{th} [mm]	d_h [mm]	H_k [mm]	Impronta	Código	Precio €/bolsa	(Uds)	(Uds)
3	10	T	6	1,8	P3	31085	3,00	5000	-
4	5	T	8	2,4	P4	4585	4,60	5000	-
						4885	3,60	5000	-
5	10	T	10	3	P5	51085	5,90	5000	-
						51585	7,30	5000	-
6	15	T	12	3,6	P6	61585	10,10	5000	-

T Rosca total

Tornillo DIN 963

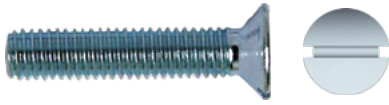

Características

- Cabeza avellanada.
- Impronta ranura.

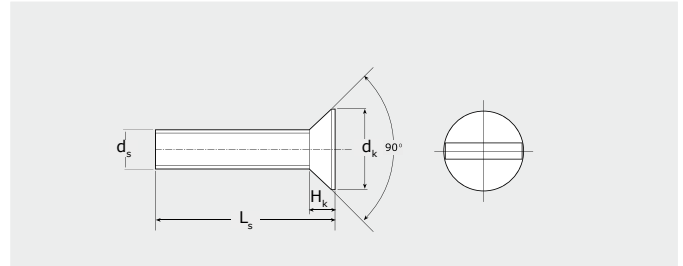

d_s : Diámetro tornillo L_{th} : Parte roscada. H_k : Altura de cabeza.
 L_s : Longitud tornillo. d_h : Diámetro cabeza.

Cajas

DIN 963 Cincado						Precios		Envase	Embalaje
d_s [mm]	L_s [mm]	L_{th} [mm]	d_h [mm]	H_k [mm]	Impronta	Código	Precio €/100 u.	(Uds)	(Uds)
3	5	T	5,6	1,65	P3	935963	3,30	1000	32000
	8					938963	2,20	1000	32000
	10					9310963	2,40	1000	16000
	12					9312963	2,50	1000	16000
	16					9316963	2,80	1000	16000
	20					9320963	3,40	1000	16000
	25					9325963	4,10	500	8000
35					9335963	6,20	250	4000	
4	8	T	7,5	2,2	P4	948963	4,20	500	16000
	10					9410963	3,50	500	16000
	16					9416963	4,40	500	8000
	20					9420963	6,60	500	8000
	25					9425963	7,00	500	4000
	30					9430963	7,40	500	4000
	40					9440963	9,10	250	4000
50					9450963	14,10	250	4000	
5	8	T	9,2	2,5	P5	958963	4,50	500	16000
	10					9510963	4,70	500	16000
	12					9512963	5,30	250	8000
	16					9516963	5,90	250	8000
	20					9520963	6,40	250	4000
	25					9525963	8,00	250	4000
	30					9530963	8,40	250	4000
40					9540963	11,20	250	2000	
45					9545963	14,00	250	2000	
50					9550963	16,00	250	2000	
6	16	T	11	3	P6	9616963	8,00	250	4000
	20					9620963	9,60	250	4000
	25					9625963	11,00	250	2000
	30					9630963	12,20	250	2000
	40					9640963	15,30	250	2000
	50					9650963	19,30	250	2000
60					9660963	21,60	50	800	

Bolsas

DIN 963 Cincado						Precios		Envase	Embalaje
d_s [mm]	L_s [mm]	L_{th} [mm]	d_h [mm]	H_k [mm]	Impronta	Código	Precio €/bolsa	(Uds)	(Uds)
4	15	T	7,5	2,2	P4	415963	3,90	2500	-
6	15	T	11	3	P6	615963	7,90	1000	-

Blister

DIN 963 Cincado						Precios		Envase	Embalaje	
d_s [mm]	L_s [mm]	L_{th} [mm]	d_h [mm]	H_k [mm]	Impronta	Código	Precio €/blister	(Uds)	(Uds)	(Uds)
3	10	T	5,6	1,65	P3	7310963	3,20	35	10	350
4	10	T	7,5	2,2	P4	7410963	3,20	20	10	200
	16					7416963	3,20	20	10	200
	20					7420963	3,20	20	10	200
	25					7425963	3,20	20	10	200
5	10	T	9,2	2,5	P5	7510963	3,20	20	10	200
	20					7520963	3,20	15	10	150
	25					7525963	3,20	10	10	100

Tornillo DIN 933

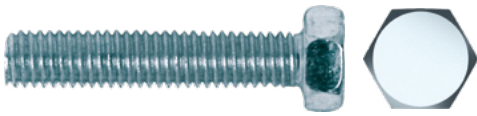

Características

- Cabeza hexagonal.
- Forma embutida (M3, M4, M5).
- Cabeza recortada (M6, M8).
- Clase 4.8.

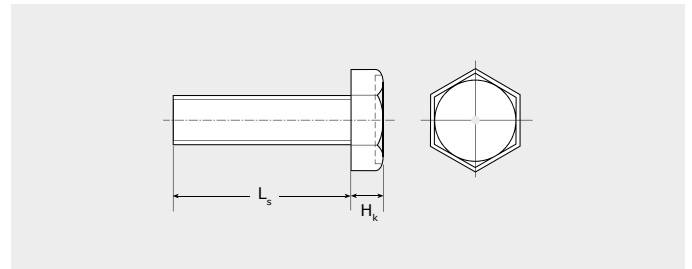

L_s : Longitud tornillo.
 H_k : Altura de cabeza.

Cajas

DIN 933				Precios		Envase	Embalaje			
d_s [mm]	L_s [mm]	H_k [mm]	Impronta	Código	Precio €/100 u.	(Uds)	(Uds)			
3	10	2	SW5,5	9310933	3,60	1000	16000			
	20			9320933	4,30	1000	16000			
	30			9330933	5,40	500	8000			
4	8	2,8	SW7	948933	3,90	500	16000			
	10			9410933	4,20	500	16000			
	12			9412933	4,20	500	16000			
	15			9415933	4,20	500	8000			
	20			9420933	4,70	500	8000			
	25			9425933	5,30	500	8000			
	40			9440933	8,00	250	4000			
	45			9445933	9,40	250	4000			
5	10	3,5	SW8	9510933	5,70	500	8000			
	15			9515933	5,90	250	8000			
	20			9520933	6,60	250	8000			
	45			9545933	11,70	250	2000			
	60			9560933	16,20	250	2000			
	70			9570933	23,30	100	2000			
	6			10	4	SW10	9610933	7,00	250	8000
12		9612933	7,00	250			4000			
16		9616933	7,30	250			4000			
20		9620933	8,10	250			4000			
25		9625933	9,10	250			4000			
30		9630933	10,90	250			4000			
40		9640933	14,10	250			2000			
50		9650933	16,00	250			2000			
8		16	5,3	SW13			9816933	16,00	100	1600
		20					9820933	16,40	100	1600
	25	9825933			18,40	100	1600			
	30	9830933			19,50	100	1600			
	35	9835933			20,80	100	800			
	40	9840933			20,80	75	1200			
	45	9845933			25,40	100	800			
	50	9850933			27,70	50	800			
	60	9860933			31,40	50	400			
	70	9870933			39,10	40	400			

T Rosca total

Bolsas

DIN 933					Precios		Envase	Embalaje
d_s [mm]	L_s [mm]	L_{th} [mm]	H_k [mm]	Impronta	Código	Precio €/bolsa	(Uds)	(Uds)
3	15	T	2	SW5,5	315933	3,60	5000	-
4	65	T	2,8	SW7	465933	17,10	250	-
	70				470933	18,60	250	-
5	50	T	3,5	SW8	550933	14,40	250	-
8	15	T	5,3	SW13	815933	14,40	250	-
	20				820933	16,40	250	-

Blister

DIN 933					Precios		Envase	Embalaje
d_s [mm]	L_s [mm]	L_{th} [mm]	H_k [mm]	Impronta	Código	Precio €/blister	(Uds)	(Uds)
4	10	T	2	SW5,5	7410933	3,20	25	10
	15				7415933	3,20	20	200
	20				7420933	6,30	100	1000
	20				7420933	3,20	20	200
	30				7430933	3,20	15	150
5	10	T	2,8	SW7	7510933	3,20	20	200
	10				4510933	6,30	90	900
	15				7515933	3,20	15	150
	15				4515933	6,30	70	700
	20				7520933	3,20	15	150
6	10	T	4	SW10	4520933	6,30	65	650
	10				7610933	3,20	15	150
	10				4610933	6,30	65	650
	16				7616933	3,20	10	100
	16				4616933	6,30	60	600
	20				7620933	3,20	10	100
	20				4620933	6,30	60	600
	25				7625933	3,20	10	100
	25				4625933	6,30	50	500
	30				7630933	3,20	10	100
8	16	T	5,3	SW13	7640933	6,30	45	450
	16				4630933	3,20	6	60
	20				7650933	3,20	6	60
	20				4640933	6,30	40	400
	20				7650933	3,20	6	60
	25				7816933	3,20	6	60
	25				4816933	6,30	30	300
	25				7820933	3,20	6	60
	25				4820933	6,30	30	300
	25				7825933	3,20	6	60
40	40	T	5,3	SW13	4825933	6,30	25	250
	30				7830933	3,20	4	40
	30				4830933	6,30	25	250
	30				7830933	3,20	4	40
	30				4830933	6,30	25	250
	40				7840933	3,20	2	20
	40				4840933	6,30	20	200
	40				7850933	3,20	2	20
	40				4840933	6,30	20	200
	40				7860933	3,20	2	20
60	60	T	5,3	SW13	4860933	6,30	15	150
	60				7870933	3,20	2	20
	60				4870933	6,30	10	100
	60				7870933	3,20	2	20

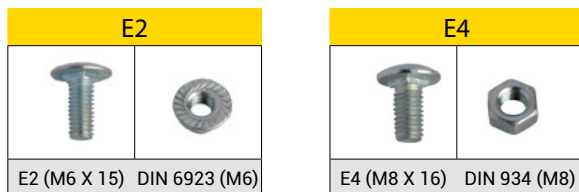

T Rosca total

Tornillo estantería E2 / E4



Características

- Cuello especial estantería (E4).
- Cuello bajo (E2).

DIN E2						Precios		Envase	Embalaje
d_s [mm]	L_s [mm]	L_{th} [mm]	d_n [mm]	H_k [mm]	Impronta	Código	Precio €/100 u.	 (Uds)	 (Uds)
6	15	6	16	3,88	-	9E2	15,50	250	2000

DIN E4						Precios		Envase	Embalaje
d_s [mm]	L_s [mm]	L_{th} [mm]	d_n [mm]	H_k [mm]	Impronta	Código	Precio €/100 u.	 (Uds)	 (Uds)
8	16	6	20	4,88	-	9E4	27,80	250	2000

Tuerca imperdible COMBY



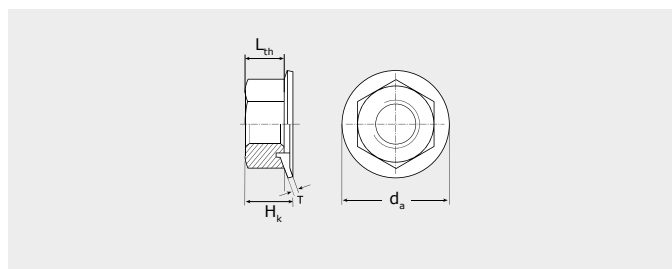

Características

- Clase 8.
- Bicromatado.
- Arandela y tuerca estan ensambladas pero giran libremente una respecto a la otra.
- Ahorro de tiempo. La tuerca y arandela están premontadas.
- Mayor seguridad. La arandela elástica evita el aflojamiento por vibración.



L_{th} : Parte roscada.
 H_k : Altura de cabeza.
 d_a : Diámetro exterior.

Bolsas

COMBY					Precios		Envase	Embalaje
d_s [mm]	L_{th} [mm]	H_k [mm]	d_a [mm]	Impronta	Código	Precio €/bolsa	 (Uds)	 (Uds)
M4	3,2	4,05	10	SW7	B4COMBY	12,80	5000	15.000
M5	4	5,15	12	SW8	B5COMBY	17,20	2500	10.000
M8	6,5	8,3	18	SW13	B8COMBY	40,60	500	2.000

Tuerca DIN 934



Características

- Tuerca hexagonal.
- Acero clase 8.

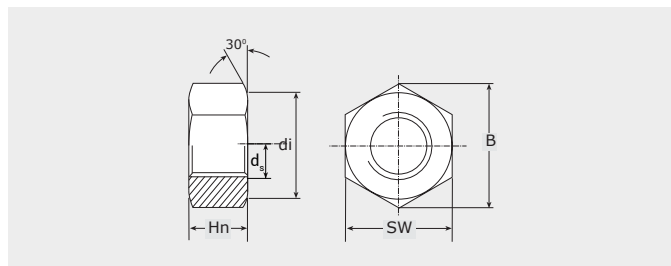

D_s: Diámetro tornillo B: Ancho
H_n: grosor tuerca d_i: Diámetro interior

Cajas

DIN 934 Cincado					Precios		Envase	Embalaje
d _s [mm]	SW [mm]	B [mm]	H _n [mm]	d _i [mm]	Código	Precio €/100 u.	(Uds)	(Uds)
M3	5,5	6,08	2,4	4,95	93934	1,80	1000	32000
M4	7	7,74	3,2	6,3	94934	2,40	1000	32000
M5	8	8,87	4	7,2	95934	2,90	500	16000
M6	10	11,05	5	9	96934	5,10	500	8000
M8	13	14,38	6,5	11,7	98934	10,50	250	4000
M10	17	18,90	8	15,3	910934	20,50	250	1000
					910934200	19,70	200	1600
M12	19	21,10	10	17,1	912934	31,40	100	1600

Bolsas

DIN 934 en bolsa					Precios		Envase	Embalaje
d _s [mm]	SW [mm]	B [mm]	H _n [mm]	d _i [mm]	Código	Precio €/bolsa	(Uds)	(Uds)
M2	4	4,38	1,6	3,6	2934	2,00	5000	-
M2,5	5	5,51	2	4,5	25934	2,10	5000	-
M3	5,5	6,08	2,4	4,95	3934	1,40	5000	-
M3,5	6	6,64	2,8	5,4	35934	3,10	5000	-
M4	7	7,74	3,2	6,3	4934	1,90	5000	-
M6	10	11,05	5	9	6934	4,70	1250	-

Blisters

DIN 934 en blister					Precios		Envase	Embalaje	
d _s [mm]	SW [mm]	B [mm]	H _n [mm]	d _i [mm]	Código	Precio €/blister	(Uds)	(Uds)	(Uds)
M3	5,5	6,08	2,4	4,95	73934	3,20	145	10	1450
M4	7	7,74	3,2	6,3	74934	3,20	95	10	950
					44934	6,30	210	10	2100
M5	8	8,87	4	7,2	75934	3,20	75	10	750
					45934	6,30	180	10	1800
M6	10	11,05	5	9	76934	3,20	45	10	450
					46934	6,30	115	10	1150
M8	13	14,38	6,5	11,7	78934	3,20	20	10	200
					48934	6,30	55	10	550
M10	17	18,90	8	15,3	710934	3,20	10	10	100
					410934	6,30	28	10	280
M12	19	21,10	10	17,1	712934	3,20	6	10	60

Tuerca DIN 439



Características

- Tuerca hexagonal baja.
- Acero clase 8.

Bolsas

DIN 439 Cincado				Precios		Envase	Embalaje
d_s [mm]	H_k [mm]	SW	Código	Precio €/bolsa	(Uds)	(Uds)	
M4	2,2	SW7	4439	1,80	5000	-	
M5	2,7	SW8	5439	2,40	5000	-	

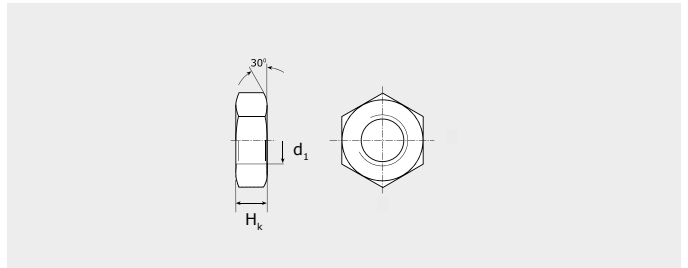

d_1 : Diámetro
 H_k : Altura de cabeza.

Tuerca autoblocante DIN 985 / DIN 6923



DIN 985



DIN 6923

Características

- DIN 985: Autoblocantes C8. Cincadas con inserto de nylon.
- DIN 6923: Autoblocantes con valona estriada Bicromatado/Cincado.

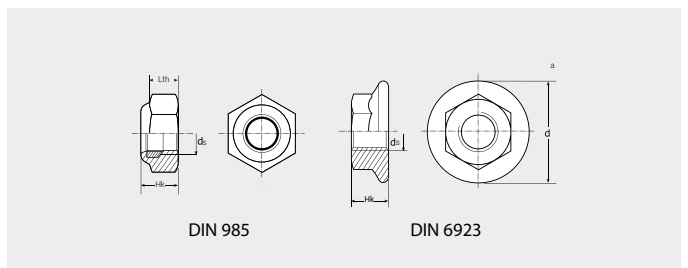

d_s : Diámetro tornillo
 L_{th} : Parte roscada.
 H_k : Altura de cabeza.
 da : Diámetro exterior.

Cajas

DIN 985				Precios		Envase	Embalaje
d_s [mm]	L_{th} [mm]	H_k [mm]	SW	Código	Precio €/100 u.	(Uds)	(Uds)
M4	2,9	5	7	94985	5,20	500	16000
M5	3,2	5	8	95985	5,30	500	16000
M6	4	6	10	96985	8,40	250	8000
M8	5,5	8	13	98985	13,50	250	4000
M10	6,5	10	17	910985	27,90	250	2000

Bolsas

DIN 985				Precios		Envase	Embalaje
d_s [mm]	L_{th} [mm]	H_k [mm]	Impronta	Código	Precio €/bolsa	(Uds)	(Uds)
M3	2,4	4	5,5	3985	4,20	1000	-
M12	8	12	19	12985	38,00	500	-

Blister

DIN 985				Precios		Envase	Embalaje
d_s [mm]	L_{th} [mm]	H_k [mm]	Impronta	Código	Precio €/blister	(Uds)	(Uds)
M4	2,9	5	7	74985	3,20	30	10 300
M5	3,2	5	8	75985	3,20	30	10 300
M6	4	6	10	76985	3,20	20	10 200
				46985	6,30	65	10 650
M8	5,5	8	13	78985	3,20	10	10 100
				48985	6,30	42	10 420
M10	6,5	10	17	710985	3,20	8	10 80
M12	8	12	19	712985	3,20	4	10 40

Bolsas

DIN 6923 Cincado					Precios		Envase	Embalaje
d _s [mm]	L _{th} [mm]	d _a [mm]	H _k [mm]	Impronta	Código	Precio €/bolsa	(Uds)	(Uds)
M4	T	10	4	7	46923	6,30	5000	-
M5		11,8	5	8	56923	7,20	2500	-
M6		14,2	6	10	66923	7,80	500	-

DIN 6923 Bicromatado					Precios		Envase	Embalaje
d _s [mm]	L _{th} [mm]	d _a [mm]	H _k [mm]	Impronta	Código	Precio €/bolsa	(Uds)	(Uds)
M4	T	10	4	7	B46923	6,30	500	-
M5		11,8	5	8	B56923	7,20	500	-
M6		14,2	6	10	B66923	7,80	500	-
M8		17,4	8	13	B86923	13,80	500	-

Tuerca de neopreno CFLEX

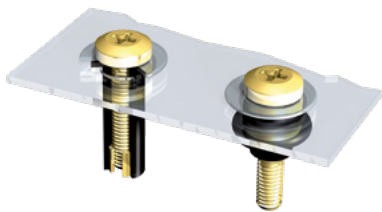

Características

- Versátil, adaptable y reutilizable.
- Utilizable en agujeros ciegos y pasantes.
- Unión de chapas finas.
- Aislamiento de sistemas con vibración.
- Fijación de materiales frágiles (metacrilato, porcelana, cristal,...)
- Nota: no aplicar este producto en contacto con disolventes o pinturas, ya que pueden afectar las propiedades del material flexible.
- Camisa de neopreno e inserto de latón.

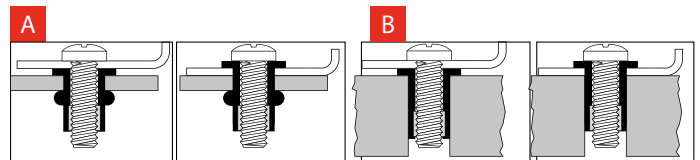
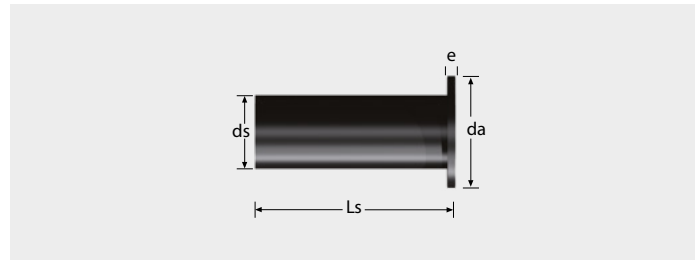
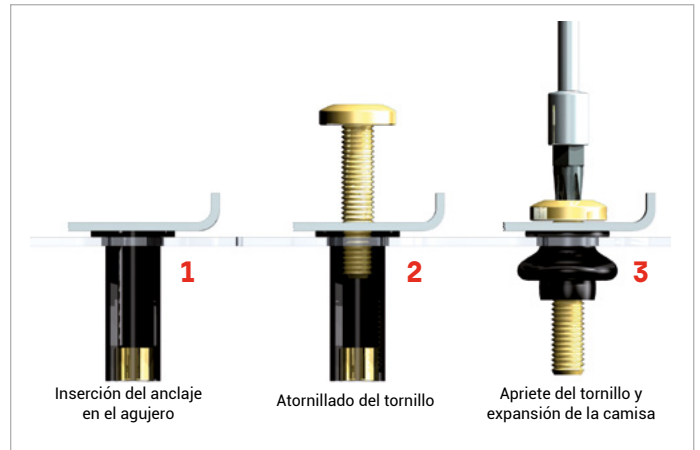

Fijaciones de chapas o materiales macizos con aislamiento de vibraciones.

Fijaciones de chapas o materiales macizos con aislamiento de vibraciones.

CFLEX										Precios		Envase	Embalaje	CFLEX	
ø	Ref.	ds	da	L _s	e	Medida tornillo	da	Grosor ensamble	Par de apriete	Código	Precio €/100 u.	(Uds)	(Uds)	Código	Precio
M4	CF1	8-8,3	11,00	12,60	1,40	M4 x 0,7	11,00	0,4-4	2,5-4	9CF1	60,20	100	3200	CF1	A y B
M5	CF2	9,7-9,9	12,70	14,10	0,90	M5 x 0,8	12,70	0,4-4,9	3,5-5	9CF2	73,60	100	3200	CF2	B
	CF3	9,7-9,9	19,00	18,00	2,00	M5 x 0,8	19,00	0,8-5,8	3-7	9CF3	86,80	100	1600	CF3	A
	CF4	9,7-9,9	14,00	26,10	1,30	M5 x 0,8	14,00	7,9-16	3-7	9CF4	97,40	100	800	CF4	B
M6	CF5	12,8-13	16,00	16,00	1,30	M6 x 1,0	16,00	0,4-2,8	6-10	9CF5	100,50	100	1600	CF5	B
	CF7	12,8-13	16,30	26,70	2,00	M6 x 1,0	16,30	6,4-11,5	8-10	9CF7	104,50	50	800	CF7	B
M8	CF8	16-16,2	22,10	18,30	3,20	M8 x 1,25	22,10	0,4-4	10-15	9CF8	146,40	50	400	CF8	A
	CF9	15,7-16	21,50	27,90	5,70	M8 x 1,25	21,50	4-9,5	10-16	9CF9	165,00	50	400	CF9	A y B

Arandela EPDM 7711 / EPDM 7712



Características

- Arandelas planas de estanqueidad.
- Arandelas de acero y EPDM (7711).
- Arandelas Inox A2 y EPDM (7712).
- Cuando se requiere una estanqueidad contra la entrada de agua, polvo, etc. También utilizada para absorber vibraciones y dilataciones y sujetar materiales frágiles.

DIN 7711			Precios		Envase	Embalaje
ds	da	e	Código	Precio €/100 u.	(Uds)	(Uds)
4,2-4,8	14	3	914487711	4,60	500	8000
	16	3	916557711	5,50	500	8000
6-6,3	16	3	916637711	5,50	500	8000
	19	3	919637711	7,30	500	4000
	25	3,5	925637711	12,40	250	2000

DIN 7712 <small>inox</small>			Precios		Envase	Embalaje
ds	da	e	Código	Precio €/100 u.	(Uds)	(Uds)
4,2-4,8	14	3	9X14487712	18,70	500	8000
5-5,5	16	3	9X16557712	24,40	500	8000
6-6,3	16	3	9X16637712	21,30	500	8000
	19	3	9X19637712	31,90	500	4000
	25	3,5	9X25637712	63,80	250	2000

Arandela grower DIN 7980 / DIN 127B



Características

- Sección cuadrada (DIN 7980).
- Sección rectangular y forma lisa (DIN 127 B).
- Hierro pavonado.

Bolsas

DIN 7980					Precios		Envase
ø	"a	d _a [mm]	e [mm]	H _k [mm]	Código	Precio €/bolsa	(Uds)
3	4,1	5,6	1	2,4	P37980	1,20	5000
4	4,1	7	1,2	1,8	P47980	1,30	5000
5	5,1	8,8	1,6	3,2	P57980	1,40	5000

DIN 127B					Precios		Envase
ø	"a	d _a [mm]	e [mm]	H _k [mm]	Código	Precio €/bolsa	(Uds)
4	4,1	1,5	0,9	1,8	P4127B	1,30	5000

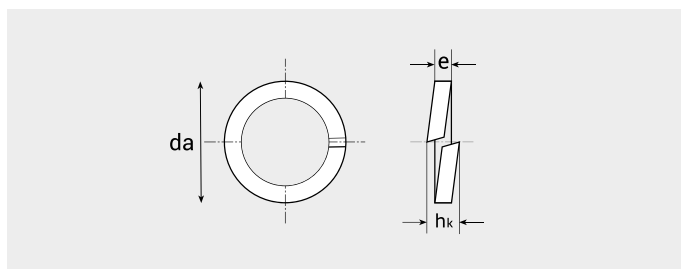

d_s : Diámetro tornillo L_{th} : Parte roscada. H_k : Altura de cabeza.
L_s : Longitud tornillo. d_h : Diámetro cabeza.

Arandela DIN 125A / DIN 9021



DIN 125A



DIN 9021

Características

- DIN 125 A: Arandela lisa.
- DIN 9021: Arandela de carroceros.

Cajas

DIN 125A				Precios		Envase	Embalaje
ø	d [mm]	d _a [mm]	e [mm]	Código	Precio €/100 u.	(Uds)	(Uds)
3	3,20	7	0,5	93125	1,30	1000	32000
4	4,30	9	0,8	94125	1,40	1000	32000
5	5,30	10	1	95125	1,70	1000	32000
6	6,40	12	1,6	96125	2,90	500	16000
8	8,40	16	1,6	98125	4,50	250	8000
10	10,50	20	2	910125	8,10	250	8000
12	13,00	24	2,5	912125	10,80	250	4000

DIN 9021				Precios		Envase	Embalaje
ø	d [mm]	d _a [mm]	e [mm]	Código	Precio €/100 u.	(Uds)	(Uds)
4	4.3	12	1	949021	3,10	500	16000
5	5.3	15	1.2	959021	5,00	500	16000
6	6.4	18	1.6	969021	6,30	500	8000
8	8.4	24	2	989021	12,20	250	4000
10	10.5	30	2.5	9109021	25,70	100	1600
12	13	37	3	9129021	65,20	100	800
12	13	37	3	912902150	62,00	50	400

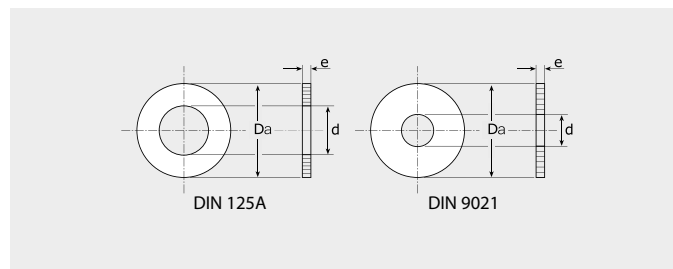

Blister

DIN 125A				Precios		Envase	Embalaje	
ø [mm]	d [mm]	d _a [mm]	e [mm]	Código	Precio €/blister	(Uds)	(Uds)	(Uds)
3	3,20	7	0,5	73125	3,20	250	10	2500
4	4,30	9	0,8	74125	3,20	210	10	2100
5	5,30	10	1	75125	3,20	200	10	2000
6	6,40	12	1,6	76125	3,20	75	10	750
8	8,40	16	1,6	78125	3,20	40	10	400

Arandela dentada **DIN 6798** **J ADI / DIN 6798 A ADE**



DIN 6798 J
ADI



DIN 6798 A
ADE

Características

- Dentado interior ADI (DIN 6798 J).
- Dentado exterior ADE (DIN 6798 A).
- Hierro pavonado.

Bolsas

DIN 6798 J ADI				Precios		Envase	Embalaje
∅	"a	d _s [mm]	e [mm]	Código	Precio €/bolsa	(Uds)	(Uds)
3	3,2	6	0,4	P36798J	1,40	5000	35.000
4	4,3	8	0,5	P46798J	1,70	5000	35.000
8	8,4	15	0,8	P86798J	4,50	2500	10.000

DIN 6798 A ADE				Precios		Envase	Embalaje
∅	"a	d _s [mm]	H _k [mm]	Código	Precio €/bolsa	(Uds)	(Uds)
3	3,2	6	0,4	P36798A	1,40	5000	35.000
4	4,3	8	0,5	P46798A	1,70	5000	35.000
5	5,3	10	0,6	P56798A	1,90	5000	35.000
6	6,4	11	0,7	P66798A	2,20	2500	30.000
10	10,5	18	0,9	P106798A	9,70	1000	4.000

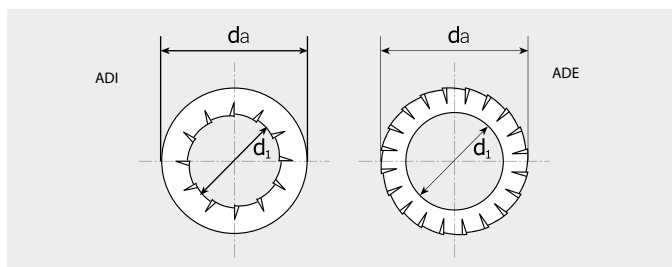

d_s : Diámetro tornillo L_{th} : Parte roscada. H_k : Altura de cabeza.
L_s : Longitud tornillo. d_h : Diámetro cabeza.

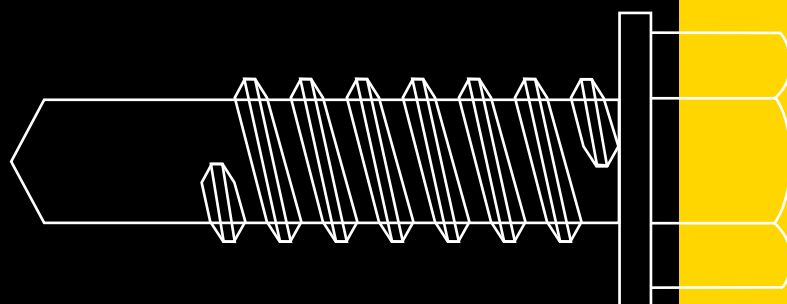

Tornillos para cubiertas y fachadas

Tornillo broca hexagonal cabeza nylon TORN	318
Tornillo hexagonal arandela EPDM CH78	318
Tornillo 7301	319
Tornillo broca larga + EPDM 7331	320
Tornillo hexagonal 7661 / 7660	320
Tornillo broca larga + EPDM 7361	321
Retén flexible MFL	322
Retén flexible abierto RF	323
Tapón envolvente para tornillos de fachadas o cubiertas TAPEX	323

Tornillo broca hexagonal cabeza nylon **TORN**



Características

- Cabeza hexagonal de nylon (SW11).
- Punta broca.
- Colores blanco y negro.
- Para fijar lucernarios y cubiertas metálicas.
- Fijación directa, sin taladro previo.
- Armonización perfecta de colores entre tornillo y cubierta.
- Color inalterable gracias a los colorantes de larga vida.

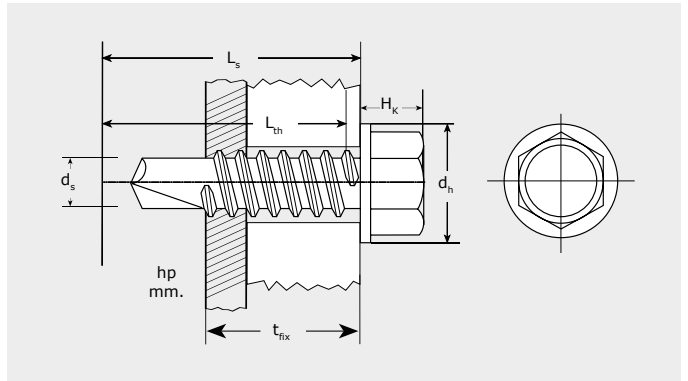

d_s : Diámetro tornillo
 L_s : Longitud tornillo.
 L_{th} : Parte roscada.
 d_h : Diámetro cabeza.

H_k : Altura de cabeza.
 t_{fix} : Espesor Max. a fijar
 H_p : Grosor de placa

TORN					Cincado			Precios		Envase	Embalaje
d_s [mm]	L_s [mm]	L_{th} [mm]	$h_p \leq$ [mm]	$T_{fix} \leq$ [mm]	d_h [mm]	H_k [mm]	Impronta	Código	Precio €/100 u.	Uds	Uds
6,3	19	T	5	11	16	9,2	SW11	9BL6319TORN	31,90	250	4000
				17				9NG6319TORN	31,90	250	4000
	25							9BL6325TORN	35,80	250	4000
								9NG6325TORN		250	4000

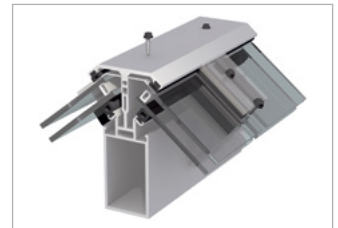

Tornillo hexagonal arandela EPDM **CH78**



Características

- Tornillo rosca chapa para fijación de cubiertas metálicas sobre correas.
- Al realizar su pedido rogamos indiquen siempre si desean el tornillo solo Ref. CH78, o bien con arandela montada indicando su diámetro.
- Se puede montar en taco de nylon NF o FX.
- Arandela acero / EPDM.
- Llave hexagonal SW 10

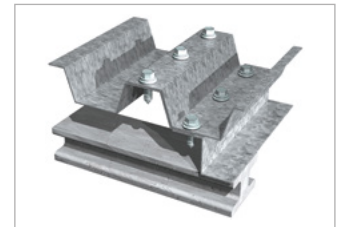

CH78						Precios		Envase	Embalaje
d_s [mm]	L_s [mm]	d_h [mm]	d_s [mm]	H_k [mm]	Impronta	Código	Precio €/100 u.	Uds	Uds
6,3	19	-	15,2	7	SW10	96319CH78	11,00	250	2000
	25	-				96325CH78	12,40	250	2000
		A16				96325CH7816	20,50	1000	2000
		A19				96325CH7819	22,20	500	2000
		A25				96325CH7825	24,90	250	1000
	40	-				96340CH78	16,00	250	2000
		A25				96340CH7825	29,20	250	1000
	50	-				96350CH78	19,80	100	800
		A16				96350CH7816	27,70	100	800
		A19				96350CH7819	28,20	250	1000
		A25				96350CH7825	32,20	250	1000
	60	-				96360CH78	21,90	100	800
		A16				96360CH7816	29,90	250	1000
		A19				96360CH7819	31,40	250	1000
		A25				96360CH7825	34,30	250	1000
	80	-				96380CH78	28,20	50	400
		A19				96380CH7819	41,60	100	400
		A25				96380CH7825	41,60	200	-

Tornillo 7301

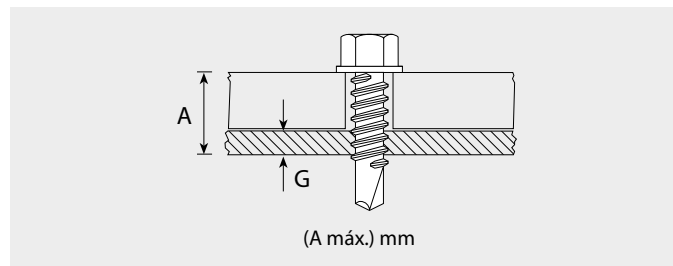

Características

- Cabeza hexagonal.
- Acero cincado.
- Arandela acero / EPDM.

d_s : Diámetro tornillo L_{th} : Parte roscada. H_k : Altura de cabeza.
 L_s : Longitud tornillo. d_h : Diámetro cabeza.

7301 Cincado										Precios		Envase	Embalaje
d_s [mm]	L_s [mm]	L_{th} [mm]	hp< [mm]	$t_{tr}<$ [mm]	d_h [mm]	H_k [mm]	d_a [mm]	Impronta	Código	Precio €/100 u.	 (Uds)	 (Uds)	
4,8	16	T	3	2	9,8	4,45	14	SW8	948167301	8,50	1.000	4.000	
	16			2			16		94816730116	8,50	1.000	4.000	
	19			5			14		948197301	9,00	1.000	4.000	
	19			5			16		94819730116	9,30	500	2.000	
	25			11			14		948257301	10,30	1.000	4.000	
	25			11			16		94825730116	10,70	500	2.000	
	32			18			14		948327301	11,00	500	2.000	
38			24			14	948387301	12,10	500	2.000			
5,5	19	T	5	5	11	5,45	16	SW8	955197301	10,30	500	2.000	
	22			8			16		955227301	11,20	1.000	4.000	
	32			18			16		955327301	15,20	500	2.000	
	38			24			16		955387301	16,40	500	2.000	
	50			36			16		955507301	18,00	250	1.000	
	63			49			16		955637301	19,90	500	800	
6,3	19	T	5	3,5	13,2	6,45	16	SW10	963197301	15,30	500	2.000	
	25			9,5			16		963257301	15,90	500	2.000	
	25			9,5			19		96325730119	17,70	250	2.000	
	25			9,5			25		96325730125	21,70	250	2.000	
	32			16,5			16		963327301	17,40	250	2.000	
	38			22,5			16		963387301	20,00	100	800	
	50			34,5			16		963507301	22,30	250	800	
	63			47,5			16		963637301	25,10	250	1.000	

Tornillo broca larga + EPDM 7331



Características

- Autotaladrante.
- Punta broca N°5.
- Cincado.
- Arandela acero / EPDM (Ref. 7331).

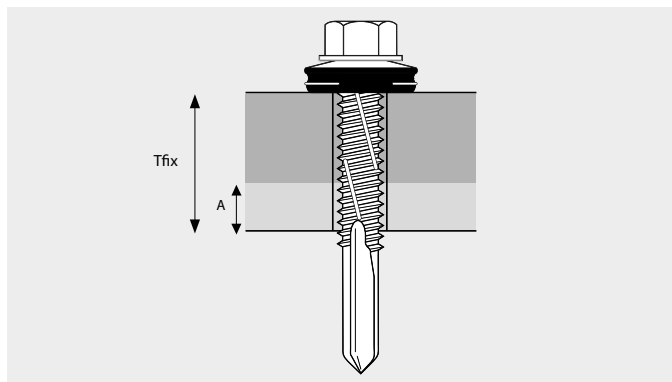

d_s : Diámetro tornillo
 L_s : Longitud tornillo.
 L_{th} : Parte roscada.
 d_h : Diámetro cabeza.
 H_k : Altura de cabeza.
 T_{fix} :
 hp :

7331 Cincado									Precios		Envase	Embalaje
d_s [mm]	L_s [mm]	L_{th} [mm]	d_h [mm]	H_k [mm]	d_a	$h_p \leq$ [mm]	$T_{fix} \leq$ [mm]	Impronta	Código	Precio €/100 u.	Envase (Uds)	Embalaje (Uds)
5,5	32	T	11	5,4	16	12	11	SW8	955327331	28,40	250	2000
	38						17		955387331	32,20	250	2000

Tornillo hexagonal 7661 / 7660

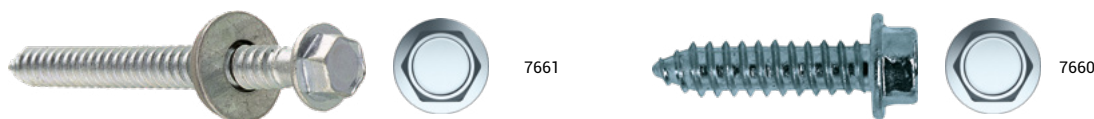

Características

- Llave vaso tipo SW8.

7661 Cincado con arandela EPDM							Precios		Envase	Embalaje
d_s	L_s	L_{th}	d_a [mm]	d_h [mm]	H_k [mm]	Impronta	Código	Precio €/100 u.	Envase (Uds)	Embalaje (Uds)
6,3	25	T	16	11,5	5	SW8	963257661	20,70	250	2000

7660 Cincado						Precios		Envase	Embalaje
d_s	L_s	L_{th}	d_h [mm]	H_k [mm]	Impronta	Código	Precio €/100 u.	Envase (Uds)	Embalaje (Uds)
6,3	19	T	11,5	5	SW8	963197660	10,50	250	4000
	25					963257660	12,00	250	4000
	38					963387660	17,90	250	2000
	50					963507660	20,90	100	800
	65	P				963657660	31,50	100	800
	75					963757660	33,50	100	800
	90					963907660	39,60	100	800

Tornillo broca larga + EPDM 7361



Características

- Autotaladrante.
- Punta N° 3.
- Arandela acero / EPDM.

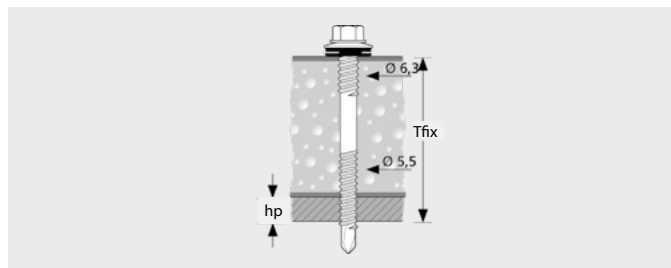

d_s : Diámetro tornillo
 L_s : Longitud tornillo.
 L_{th} : Parte roscada.
 d_h : Diámetro cabeza.
 H_k : Altura de cabeza.

DIN 7361 Bicromatado									Precios		Envase	Embalaje
d_s [mm]	L_s [mm]	L_{th} [mm]	d_h [mm]	d_a [mm]	H_k [mm]	$h_p <$ [mm]	$t_{fix} <$ [mm]	Impronta	Código	Precio €/100 u.	 (Uds)	 (Uds)
5,5	57	34	11	16	4,4	6	47	SW8	9B55577361	28,20	500	500
	82	40					72		9B55827361	33,30	500	500
	98	40					88		9B55987361	42,80	500	500
	115	40					105		9B551157361	49,20	500	500

Retén flexible MFL



Características

- Fácil Instalación.
- Adaptable y resistente.
- Fabricado en EPDM.
- Perfecta estanqueidad en la salida de tubo a través de cualquier cubierta o paramento.
- Instalación fácil y rápida. Se coloca en sólo 10 minutos.
- Adaptable a todo tipo de cubiertas. La base flexible de aluminio se adapta a cualquier forma y dimensión de onda. Tampoco importa que el tubo quede centrado en el valle o en el vértice de la onda.
- Adaptable a todo tipo de tubos. Master Flash® se ofrece en 9 modelos para tubos desde 6 mm a 660 [mm]
- Resistente a la intemperie y a las dilataciones de cubiertas.
- Fabricado en EPDM de alta calidad, resiste largos años al envejecimiento producido por el ozono y los rayos ultravioletas. El EPDM resiste temperaturas continuas de -55°C a +100°C.



1
Escoja el retén adecuado a su necesidad y si es necesario, córtelo hasta que el diámetro del agujero del retén sea un 20/25% inferior al diámetro del tubo.



2
Deslice el retén por el tubo (use agua como lubricante).

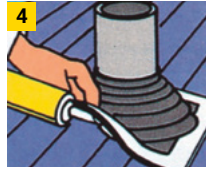

4
Aplique silicona selladora entre el retén y la cubierta.

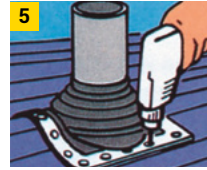

5
Atornillar la base del retén a la base de la cubierta.

El espacio entre tornillos no debe ser superior a 38 mm para cubiertas de fibrocemento.

MFL		Precios		Envase	Embalaje
∅ [mm]	Ref.	Código	Precio €/100 u.	(Uds)	(Uds)
114x114	6-50	MF1	52,00	1	25
203x203	6-102	MF3	70,70	1	1
254x254	76-152	MF4	108,20	1	1
279x279	102-178	MF5	119,40	1	1
305x305	127-228	MF6	139,80	1	1
356x356	152-280	MF7	178,90	1	1
432x432	178-330	MF8	269,10	1	1
635x634	254-467	MF9	460,90	1	1
864x864	330-660	MFMAX	775,00	1	1

Retén flexible abierto RF



Características

- Retén flexible.
- Asegura la estanqueidad.
- Retén flexible para la estanqueidad de tubos con la instalación terminada. El retén se abre para envolver el tubo. La apertura se sella finalmente para asegurar la estanqueidad.

RF		Precios		Envase	Embalaje
∅ [mm]	Ref.	Código	Precio €/u.	(Uds)	(Uds)
200x200	13-100	RF101	108,20	1	1
350x350	100-230	RF201	211,00	1	1
546x546	230-412	RF301	324,30	1	1

Tapón envolvente para tornillos de fachadas o cubiertas TAPEX



Montar



Atornillar



Cerrar

Características

- Color blanco.
- Para tornillos de fachadas o cubiertas.
- Un solo tapón se adapta a todos los tornillos de diámetro 4,8, 5,5 y 6,3 [mm]
- Cierre hermético. Resguarda de la intemperie la cabeza del tornillo.
- Sujeción perfecta. Tapón y tornillo quedan perfectamente sujetos.
- Material y color inalterables a la intemperie. Fabricado en polietileno, aguanta temperaturas de hasta +90°C/-40°C.

TAPEX		Precios		Envase	Embalaje
∅ [mm]	Ref.	Código	Precio €/100 u.	(Uds)	(Uds)
Blanco	4,8-6,3	91006TAP	16,10	1000	1000

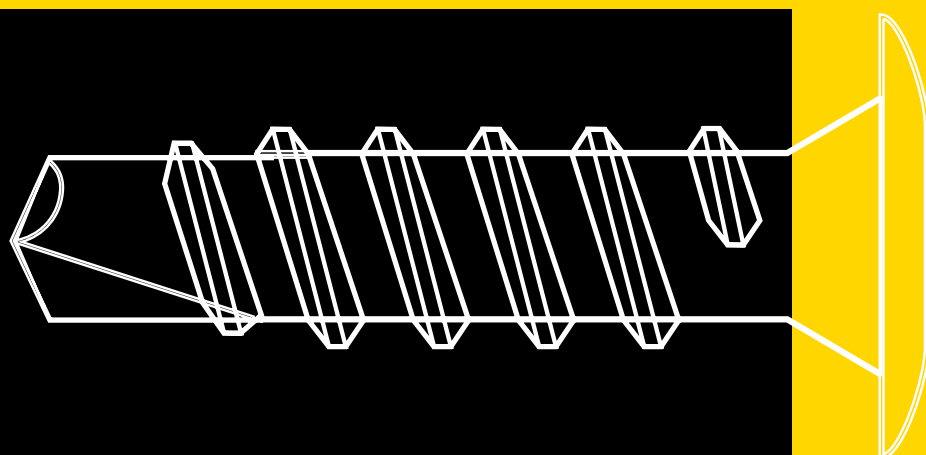

Tornillos rosca placas de yeso

Tornillo cartón yeso chapa SSF	326
Tornillo para placas de yeso GGS	326
Tornillo cartón yeso broca SSB	327
Tornillo para fibrocemento GSH	327

Tornillo cartón yeso chapa SSF

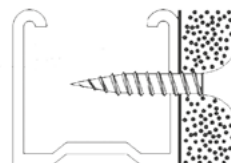

Características

- Impronta PH2.
- Tornillo doble rosca. Fosfatado. Para fijar placas de cartón yeso a perfil metálico hasta 0,8 mm de grosor.

d_s : Diámetro tornillo
 L_s : Longitud tornillo.

L_{th} : Parte roscada.
 d_h : Diámetro cabeza.

SSF Fosfatado					Precios		Envase	Embalaje
d_s [mm]	L_s [mm]	L_{th} [mm]	d_h [mm]	Impronta	Código	Precio €/100 u.	(Uds)	(Uds)
3,5	25	T	8,2	PH2	9F3525SSF	1,90	1000	16000
	35				9F3535SSF	2,40	1000	12000
	45				9F3545SSF	2,90	500	6000
	55				9F3555SSF	3,70	500	6000
3,9	25	T	8,5	PH2	9F3925SSF	2,20	1000	16000
	35				9F3935SSF	2,80	500	6000
	45				9F3945SSF	4,30	500	6000
	55				9F3955SSF	4,60	500	6000
	65				9F3965SSF	6,20	200	4000
4,2	75	T	8,5	PH2	9F4275SSF	6,50	200	4000
5	90	T	9,4	PH2	9F590SSF	14,70	500	4000

SSF Fosfatado en blister					Precios		Envase	Embalaje
d_s [mm]	L_s [mm]	L_{th} [mm]	d_h [mm]	Impronta	Código	Precio €/100 u.	(Uds)	(Uds)
3,5	25	T	8,2	PH2	7F3525SSF	3,20	1	10
	35				7F3535SSF	3,20	1	10

Tornillo para placas de yeso GGS

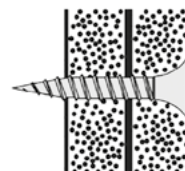

Características

- Rosca y diámetro especial para la unión de placas.

d_s : Diámetro tornillo
 L_s : Longitud tornillo.

L_{th} : Parte roscada.
 d_h : Diámetro cabeza.

GGS Fosfatado					Precios		Envase	Embalaje
d_s [mm]	L_s [mm]	L_{th} [mm]	d_h [mm]	Impronta	Código	Precio €/100 u.	(Uds)	(Uds)
5	38	T	8,5	PH2	9F538GGS	5,00	500	6000

Tornillo cartón yeso broca SSB

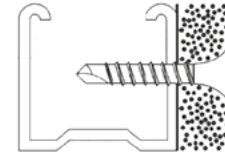

Características

- Tornillo punta broca.
- Para fijar placas de cartón yeso a perfil metálico superior a 0,8 mm de grosor.

SSB Fosfatado					Precios		Envase	Embalaje
d_s [mm]	L_s [mm]	L_{rh} [mm]	d_h [mm]	Impronta	Código	Precio €/100 u.	 (Uds)	 (Uds)
3,5	25	T	8,5	PH2	9F3525SSB	3,10	1000	8000
	35				9F3535SSB	3,70	1000	6000
	45				9F3545SSB	4,60	500	3000
	55				9F3555SSB	6,20	500	3000

Tornillo para fibrocemento GSH

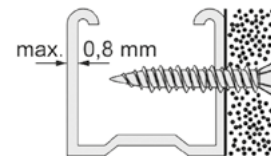

Características

- Tornillo con rosca Hi-Lo.
- Para fijar placas de fibrocemento a perfil metálico.

d_s : Diámetro tornillo L_{rh} : Parte roscada.
 L_s : Longitud tornillo. d_h : Diámetro cabeza.

GSH Fosfatado					Precios		Envase	Embalaje
d_s [mm]	L_s [mm]	L_{rh} [mm]	d_h [mm]	Impronta	Código	Precio €/100 u.	 (Uds)	 (Uds)
3,9	19	T	7,2	PH2	9F3919GSH	2,40	1000	16000
	22				9F3922GSH	2,80	1000	16000
	30				9F3930GSH	3,30	1000	12000
	35				9F3935GSH	4,30	500	6000
	45	30			9F3945GSH	4,50	500	6000
	55	37			9F3955GSH	5,80	500	6000
	65	43			9F3965GSH	6,80	200	4000

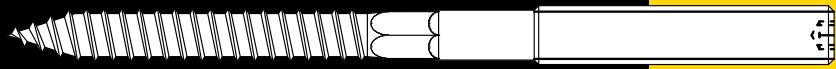

Tornillería para instalaciones

Punta broca cabeza métrica TRB	330
Llave de vaso LLTRB	331
Tornillo con manguito TRBP	331
Tornillo Tornigrap TG	332
Tornillo para grapas TGCA	332
Tornillo cabeza ancha TFC	333
Tornillo tirafondo TF	333
Punta broca AGRP	334
Espárrago doble rosca EDR	335

Punta broca cabeza métrica TRB

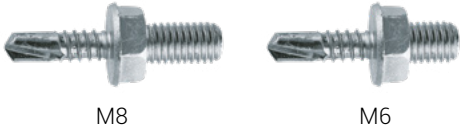

M8

M6



*En combinación con clavo XHA17 / 22

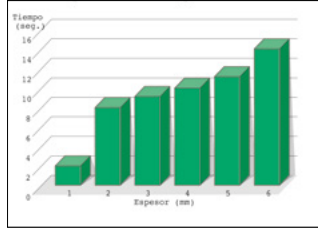

Tiempo de taladro para diferentes groesos (seg.)

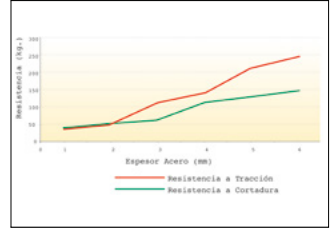

Resistencia a la tracción y cortadura según el grueso de chapa (Kg). Los valores ya llevan incorporado el coef. de seguridad figurando directamente las cargas de trabajo.

Características

- Tornillo autotaladrante rosca chapa para taladrar metales.
- Fabricado en acero con acabado cincado.
- Cabeza: hexagonal con extremo roscado M6 o M8.
- Se instala con una llave de vaso magnética de rápida manipulación y adaptable a cualquier taladro/atornillador.
- Homologación al fuego.

Instalación

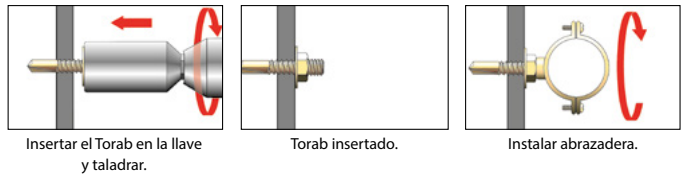

Insertar el Torab en la llave y taladrar.

Torab insertado.

Instalar abrazadera.

TRB

Rosca	Cáncamo	Gancho	Manguito	Manguito	Abrazaderas	Abrazaderas	Abrazaderas
M6x6	•	•	•	•	•		
M8x10				•			•
M8x15				•		•	

Rosca	Espesor chapa [mm]	Precios		Envase	Embalaje
		Código	Precio €/100 u.	(Uds)	(Uds)
M6x6	2-6	96319M6TRB	50,20	200	3600
M8x10	2-6	96320M810TRB	78,50	100	1800
M8x15	2-6	96320M815TRB	83,10	100	1800

Llave de vaso LLTRB



LL TB-M8



LL TB-M6

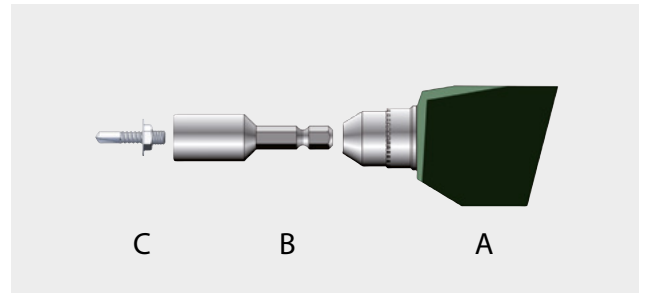

Características

- Compatible con: FT, TRB, TRBP.
- La llave de vaso (B) se acopla al taladro (A) para la colocación del tornillo Torab® (C).
- La llave puede acoplarse en atornilladores o en un portabrocas universal.

LLTRB		Precios		Envase	Embalaje
Rosca	Espesor chapa [mm]	Código	Precio €/u.	(Uds)	(Uds)
LL TRB-M6	TRB M6	910M6LLTRB	41,80	1	50
LL TRB-M8	TRB M8	913M8LLTRB	47,40	1	100

Tornillo con manguito TRBP



Características

- Sistema rápido en materiales huecos con taco de nylon FX o F.
- Permite bajar varilla en material huecos.
- Todo en una única pieza.
- Tornillo con tuerca M6 o M8.
- Acabado cincado.
- Instalación con la Llave Torab M8.
- Montaje de varillas M6 y M8 en ladrillos huecos, bloques de hormigón, placas de yeso.

Instalación

Antes

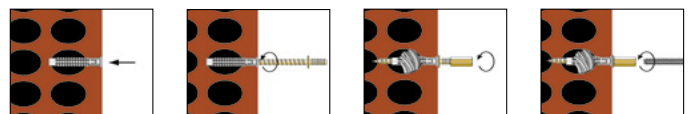

Ahora





LLTRB			Precios		Envase	Embalaje
Denom.	d _s [mm]	L _s [mm]	Código	Precio €/100 u.	(Uds)	(Uds)
TRBP M6	4,5	35	9635TRBP	48,30	100	900
TRBP M8	5,5	45	9845TRBP	96,70	50	450

Tornillo Tornigrap TG



Características

- Impronta más profunda: Pozi Nº 2 (del Nº 10 al 37) y Pozi Nº 3 (del Nº 40 al 55) con ranura.
- Fabricado en acero templado.
- Doble rosca rápida para taco nylon.
- Cono de refuerzo bajo la cabeza.
- Acabado cincado.



TG						Precios		Envase	Embalaje
Denom	d _s [mm]	L _s [mm]	Ø Taco Nylon	Plástico	Impronta	Código	Precio €/100 u.	 (Uds)	 (Uds)
Nº20	4	20	-	8 y 9	PZ2 + Ranura	920TG	6,90	100	4000
Nº30	4,5	25	6	10	PZ2 + Ranura	930TG	8,20	100	4000
Nº32	4,5	35	6	10	PZ2 + Ranura	932TG	9,30	100	4000
Nº33	4,5	45	6	-	PZ2 + Ranura	933TG	11,00	100	3600
Nº35	4,8	25	6	-	PZ2 + Ranura	935TG	9,50	100	4000
Nº37	4,8	32	6	-	PZ2 + Ranura	937TG	11,60	100	4000
Nº40	5,5	35	8	-	PZ3 + Ranura	940TG	14,50	100	1800
Nº45	5,5	45	8	-	PZ3 + Ranura	955TG	20,30	100	1800
Nº55	5,5	50	8	-	PZ3 + Ranura	945TG	19,80	100	1800

Tornillo para grapas TGCA



Características

- Fabricado en acero acabado cincado.
- Cabeza: ranurada y sobredimensionada.
- Fijación de grapas.

TGCA			Precios		Envase	Embalaje
Denom	L _s [mm]	Ø Taco Nylon	Código	Precio €/100 u.	 (Uds)	 (Uds)
Nº36	25	6	936TGCA	10,20	100	4000
Nº38	30	6	938TGCA	11,70	100	4000

Tornillo cabeza ancha TFC



Características

- Fabricado en acero templado acabado cincado.
- Para taco nylon FX o F diámetro 6[mm]

TFC				Precios		Envase	Embalaje
Denom.	d _s [mm]	L _s [mm]	Impronta	Código	Precio €/100 u.	 (Uds)	 (Uds)
TFC 4x40	4	40	PZ2	9440TFC	11,10	250	4500

Tornillo tirafondo TF



Características

- Doble rosca rápida para taco de nylon y plástico.

TF Bicromatado					Precios		Envase	Embalaje
Denom.	d _s [mm]	L _s [mm]	∅ Taco Nylon	Taco B Plástico	Código	Precio €/100 u.	 (Uds)	 (Uds)
M6	6	25	6	10	9B625TF	7,80	100	4000
M6	6	30	6	10	9B630TF	8,20	100	4000
M6	6	44	6	10	9B644TF	15,20	100	1800

TF Cincado					Precios		Envase	Embalaje
Denom.	d _s [mm]	L _s [mm]	∅ Taco Nylon	Taco B Plástico	Código	Precio €/100 u.	 (Uds)	 (Uds)
M8	8	30	8	-	9830TF	18,80	100	1800
M8	8	40	8	-	9840TF	20,20	100	1800
M8	8	50	8	-	9850TF	26,00	100	1800
M8	8	60	8	-	9860TF	29,90	100	1800
M10	10	50	10	-	91050TF	43,00	50	900

TF Bicromatado en bolsa					Precios		Envase	Embalaje
Denom.	d _s [mm]	L _s [mm]	∅ Taco Nylon	Taco B Plástico	Código	Precio €/bolsa	 (Uds)	 (Uds)
M6	6	25	6	10	B630TF	2,50	1	15
M6	6	30	6	10	B644TF	2,70	1	15

TF Cincado en bolsa					Precios		Envase	Embalaje
Denom.	d _s [mm]	L _s [mm]	∅ Taco Nylon	Taco B Plástico	Código	Precio €/bolsa	 (Uds)	 (Uds)
M8	8	40	8	-	840TF	2,90	1	15

Punta broca AGRP



Características

- Fijación rápida de grapas y de piezas, a perfiles metálicos de 1 a 4 mm de grosor.
- Tornillo autotaladrante rosca chapa para taladrar metales .
- Acabado: acero cincado.
- Cabeza ancha (9,5mm). Impronta PZ2.

Instalación

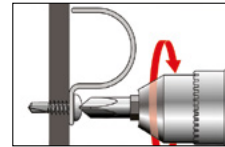

La grapa queda fijada rápidamente

AGRP					Precios		Envase	Embalaje
Denom.	d _s [mm]	Grosor a fijar	Espesor chapa a taladrar [mm]	Impronta	Código	Precio €/100 u.	 (Uds)	 (Uds)
4,2	13	6	1-3	PZ2	913AGRP	6,40	200	8000
4,8	16	7	2-4	PZ2	924AGRP	9,40	200	8000

Espárrago doble rosca EDR



TX 25 INTERIOR



Características

- Parte central hexagonal para roscar por el lateral.
- TORX® interior en la cabeza para la fijación por el frontal.

Instalación

- Tacos nylon.
- Madera (taladro previo).

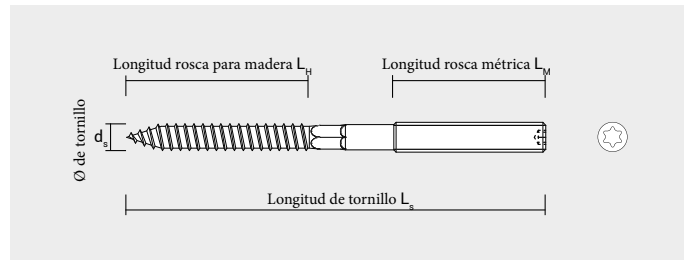

EDR					Precios		Envase	Embalaje
Denom.	d _s [mm]	L _s [mm]	Ø Taco Nylon	Impronta	Código	Precio €/100 u.	(Uds)	(Uds)
M8	8	50	10	TX25	9850EDR	25,30	100	1800
	8	60	10		9860EDR	29,30	100	1800
	8	80	10		9880EDR	34,70	50	900
	8	100	10		98100EDR	40,00	50	900
	8	120	10		98120EDR	53,80	50	900
M10	10	80	12	TX25	91080EDR	46,00	50	600
	10	90	12		91090EDR	46,00	50	600
	10	100	12		910100EDR	58,80	50	600
	10	120	12		910120EDR	62,60	50	600
M12	12	125	14	TX30	912125EDR	99,80	50	250

EDR en bolsa					Precios		Envase	Embalaje
Denom.	d _s [mm]	L _s [mm]	Ø Taco Nylon	Impronta	Código	Precio €/bolsa	(Uds)	(Uds)
M8	8	60	10	TX25	860EDR	6,30	1	15
	8	80	10		880EDR	6,30	1	15
	8	100	10		8100EDR	6,30	1	15
M10	10	80	12	TX25	1080EDR	9,70	1	15
	10	100	12		10100EDR	9,70	1	15
	10	120	12		10120EDR	9,70	1	15

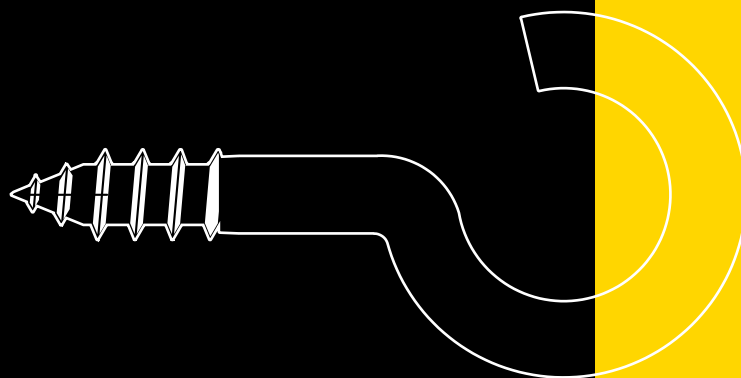

Accesorios para instalaciones

Adaptador BITRO	338
Varilla roscada 975	338
Espárrago unión ESP	339
Espárrago tope ECT	339
Cáncamo CAN	340
Gancho GAN	340
Cáncamo DIN 582	341
Manguito hexagonal MS	341
Manguito cilíndrico MSC	342
Manguito macho/ hembra M/H	342
Pistola sellado PCOL	343
Barra COLA	343
Soporte trapecio TPZ	344
Alcayata roscada ALR	344
Hembrilla abierta HA	345
Hembrilla cerrada HC	345
Clavos acero CPQ	346

Adaptador BITRO



CONVIERTE EL TALADRO EN ATORNILLADOR

Características

- Ahorra tiempo y es fácil de usar (inserción rápida).
- Adaptable a todo tipo de taladros.
- Aplicable para brocas de 6/8/10 mm de diámetro.

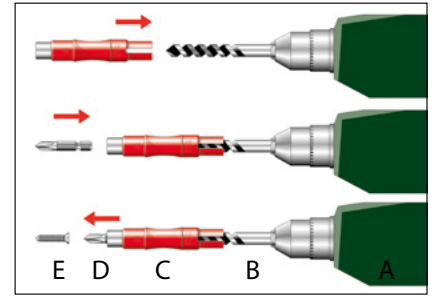

E Tornillo D Punta atornillar C Bitro B Broca A Taladro

BITRO	Precios		Envase (Uds)	Embalaje (Uds)
	Denom.	Código		
6	6BITRO	29,40	1	20
8	8BITRO	29,40	1	15
10	10BITRO	30,50	1	15

Varilla roscada 975



Características

- Fabricado en acero calidad 4.8.
- Cincado.

975	Precios		Envase (Uds)
Denom.	Código	Precio €/u.	
M4	4975	0,80	200
M6	6975	1,40	100
M8	8975	2,10	50
M10	10975	3,30	25
M12	12975	5,90	25

Espárrago unión **ESP**



Características

- Fabricado en acero cincado.
- Pieza de unión.

Espárrago ESP		Precios		Envasado		Precios		Envasado	
Rosca	Descrip.	Caja				Bolsa			
		Código	€/100 u.	(Uds)	(Uds)	Código	€/Bolsa	(Uds)	(Uds)
M6	M6 x 20	9620ESP	9,60	200	8.000	-	-	-	-
	M6 x 30	9630ESP	10,60	200	2.400	630ESP	1,40	1	15
M8	M8 x 20	9820ESP	15,00	200	2.400	-	-	-	-
	M8 x 30	9830ESP	21,20	200	2.400	-	-	-	-

Espárrago tope **ECT**

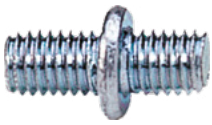

Características

- Fabricado en acero cincado.
- Pieza de unión.

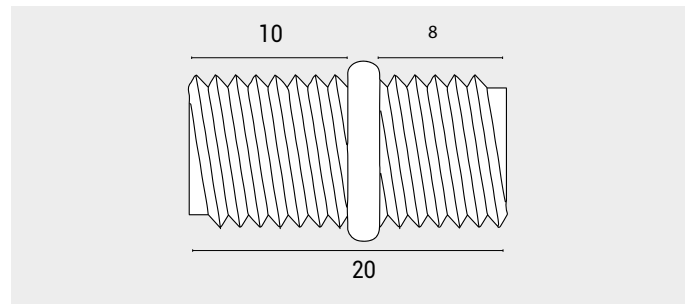

ECT	Precios		Envase	Embalaje
Rosca	Código	Precio €/100 u.	(Uds)	(Uds)
M6	9620ECT	28,60	200	3600

Cáncamo CAN



Características

- Material fundición.
- Acabado cincado.

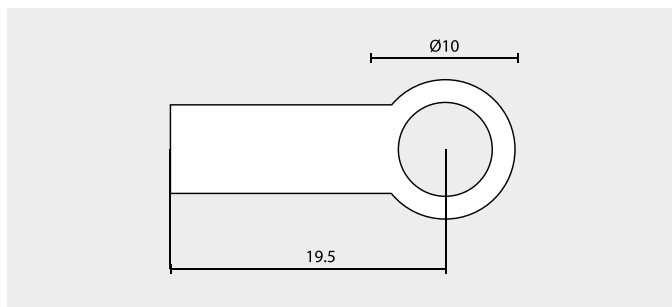

CAN	Precios		Envase (Uds)	Embalaje (Uds)
	Denom.	Código		
M6	96CAN	160,70	200	3600

Gancho GAN



Características

- Material fundición.
- Acabado cincado.

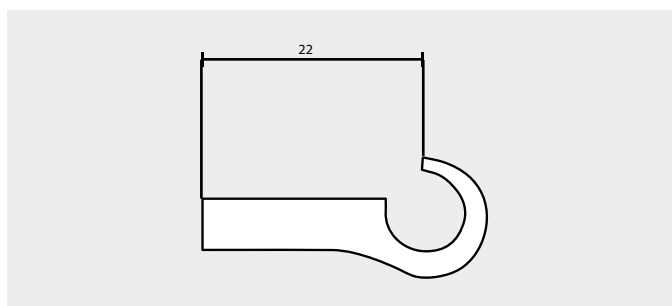

GAN	Precios		Envase (Uds)	Embalaje (Uds)
	Denom.	Código		
M6	96GAN	203,90	100	1800

Cáncamo DIN 582



Características

- Fabricado en hierro.
- Material de fundición.
- Cincado.

DIN 582		Precios		Envase	Embalaje
Denom.	Código	Precio €/100 u.		(Uds)	(Uds)
M6	96582	152,40		50	300
M8	98582	144,10		50	300

Manguito hexagonal MS



Características

- Fabricado en acero cincado.
- Pieza de unión para varillas u otros elementos roscados.

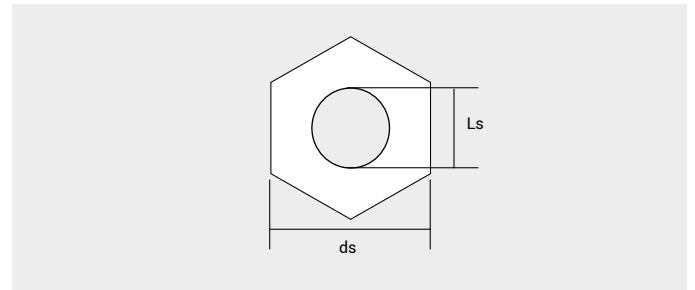

MS			Precios		Envase	Embalaje
Denom.	d_s [mm]	L_s [mm]	Código	Precio €/100 u.	(Uds)	(Uds)
M6	20	10	9620MS	35,80	200	2400
	30		9630MS	48,20	100	1200
M8	20	11	9820MS	45,90	100	1200
	25		9825MS	52,10	50	900
	30		9830MS	65,00	50	900
M10	30	13	91030MS	72,50	50	900
M12	40	17	91240MS	79,80	50	450

MS en bolsa			Precios		Envase	Embalaje
Denom.	d_s [mm]	L_s [mm]	Código	Precio €/bolsa	(Uds)	(Uds)
M6	30	10	630MS	6,30	1	15
M8	30	11	830MS	6,30	1	15
M10	30	13	1030MS	6,30	1	15

Manguito cilíndrico MSC



Características

- Fabricado en acero cincado.
- Pieza de unión para varillas u otros elementos roscados.

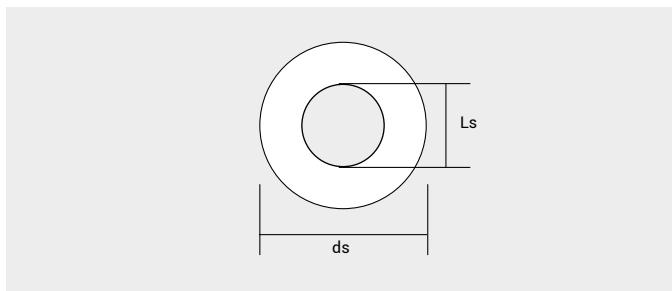

MSC			Precios		Envase	Embalaje
Denom.	d _s [mm]	L _s [mm]	Código	Precio €/100 u.	(Uds)	(Uds)
M4	15	7	9415MSC	23,10	100	4000
M6	20	10	9620MSC	27,60	200	3600
	30		9630MSC	33,60	100	1200
M8	20	11	9820MSC	35,10	100	1200
	30		9830MSC	39,80	100	1200

MSC en bolsa			Precios		Envase	Embalaje
Denom.	d _s [mm]	L _s [mm]	Código	Precio €/bolsa	(Uds)	(bolsas)
M6	30	10	630MSC	4,10	1	15

Manguito macho / hembra M/H



Características

- Fabricado en acero acabado bicromatado.
- Pieza de unión de elementos roscados M6.

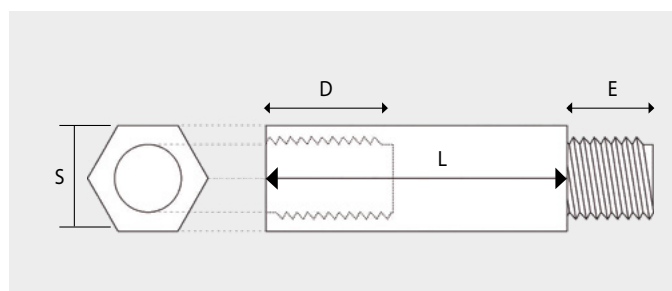



MH					Precios		Envase	Embalaje
Denom.	E [mm]	D [mm]	L [mm]	S [mm]	Código	Precio €/100 u.	(Uds)	(Uds)
M6	7	7,5	10	9	9B610MH	47,30	100	4000
	10	11	20	9	9B620MH	58,80	100	1800
	10	11	30	9	9B630MH	65,30	100	1200
	10	11	40	9	9B640MH	73,50	100	1200
	10	11	50	9	9B650MH	80,80	50	900

Pistola sellado PCOLA



Características

- Pistola sellado con adhesivo termocaliente.



PCOLA		Precios		Envase	Embalaje
Denom.	Código	Precio €/u.	 (Uds)	 (Uds)	
Pistola Colapolo	PCOLA	63,90	1	20	

Barra COLA



Características

- Adhesivo termofusible.

COLA						Precios		Envase	Embalaje
Denom.	Dimensiones [mm]	Punto de reblandecimiento	Tiempo de secado	Resistencia el calor	Temperatura de aplicación	Código	Precio €/bolsa	 (Uds)	 (Uds)
H 04 Incolora *	12x200	84 a 91°C	25 seg.	89°C	170a205°C aprox.	H04COLA	42,20	1	10

Soporte trapecio TPZ



Características

- Acero zincado.
- 2,5 mm grosor.
- 25 mm anchura.
- Permite la regulación en altura.
- Homologado fuego.
- Para la fijación de abrazaderas y varilla.
- Utilización de tuerca M8.

Instalación



Taladrar



Situar soporte



Ensamblar el soporte con tornillo/ tuerca/arandela

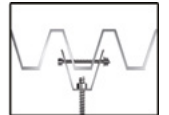

Instalar

TPZ	Precios		Envase	Embalaje
Denom	Código	Precio €/100 u.	(Uds)	(Uds)
TPZ8F	98TPZF	336,80	25	100
TPZ10F	910TPZF	336,80	25	50

Alcayata roscada ALR

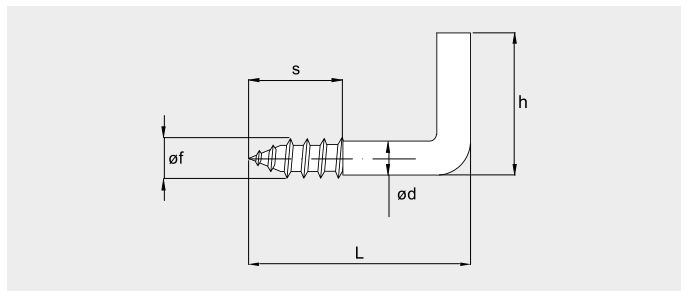

Características

- Cincado plata.

ALR						Precios		Envase	Embalaje
Diámetro [mm]	Medidas [mm]	h [mm]	ø [mm]	L [mm]	S [mm]	Código	Precio €/100 u.	(Uds)	(Uds)
2,1	14x25	10	2,6	17	11	92125ALR	3,20	500	8000
2,4	16x30	12	3	20	12	92430ALR	3,40	500	8000
2,7	17x40	13	3,5	29	16	92740ALR	5,00	500	8000
3	18x40	14	3,8	29	16	9340ALR	4,40	500	8000
	18x50	15		38	20	9350ALR	6,40	250	4000
3,5	19x50	16	4,5	37	20	93550ALR250	7,60	250	4000
	19x60	17		46	25	93560ALR	8,00	250	4000
	19x70	18		55	27	93570ALR	10,60	150	2400
4	20x50	18	4,9	36	20	9450ALR	9,00	250	4000
	20x60	18		44	24	9460ALR	9,70	250	2000
	20x80	20		63	32	9480ALR	12,90	250	2000
4,5	21x70	21	5,6	52	27	94570ALR	13,80	250	2000
	21x80	21		62	31	94580ALR	13,90	200	1600
	21x90	21		71	36	94590ALR	18,90	200	1600
	21x100	21		81	39	945100ALR	17,80	100	800

Hembrilla abierta HA



Características

- Cincado plata.

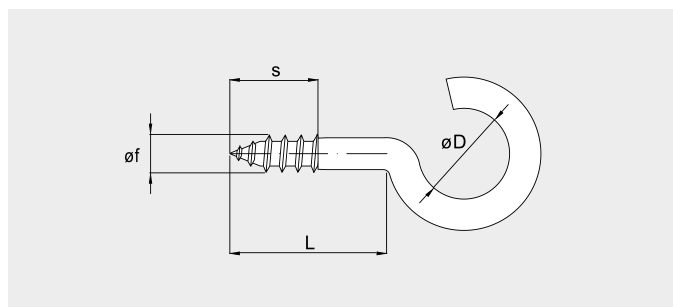

HA						Precios		Envase	Embalaje
Diámetro [mm]	Medidas [mm]	h [mm]	ø [mm]	L [mm]	S [mm]	Código	Precio €/100 u.	(Uds)	(Uds)
2,1	14x25	3,5	2,6	10	7	92125HA	3,10	500	1600
2,7	17x40	8,5	3,5	15	10	92740HA	5,70	500	8000
3	18x40	8,5	3,8	15	10	9340HA	5,80	500	8000
	18x50	9	3,8	20	13	9350HA	6,40	250	4000
3,5	19x70	15	4,5	27	18	93570HA	8,90	250	2000
4,5	20x60	13	4,9	20	15	9460HA	10,30	200	1600
	21x70	16	5,6	22	15	94570HA	13,00	250	2000
	21x80	18	5,6	27	18	94580HA	13,80	200	800
5	21x90	20	5,6	30	20	94590HA	18,80	200	1600
	22x120	24	6,2	45	30	95120HA	25,30	50	800

Hembrilla cerrada HC



Características

- Cincado plata.

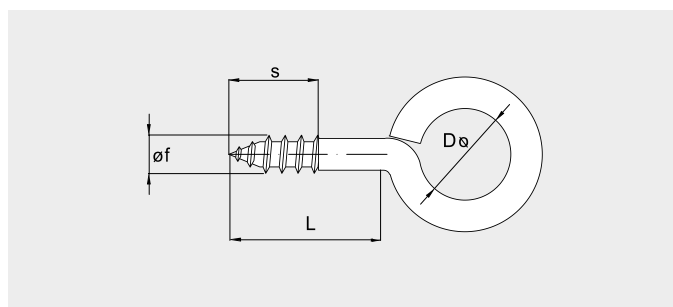

HC						Precios		Envase	Embalaje
Diámetro [mm]	Medidas [mm]	h [mm]	ø [mm]	L [mm]	S [mm]	Código	Precio €/100 u.	(Uds)	(Uds)
2,1	14x25	3,5	2,6	10	7	92125HC	3,40	500	16000
2,4	16x30	5	3	12	9	92430HC	3,60	500	16000
2,7	17x40	7	3,5	14	10	92740HC	5,30	500	8000
	18x40	6	3,8	15	10	9340HC	6,10	500	4000
3,5	18x50	7,5		20	13	9350HC	6,70	250	4000
	19x50	8	4,5	17	12	93550HC	8,30	250	4000
4	19x60	10		21	15	93560HC	8,40	250	4000
	19x70	10,5		28	18	93570HC	9,40	250	2000
	20x50	8	4,9	17	12	9450HC	9,70	250	4000
4,5	20x60	9		20	15	9460HC	10,80	250	4000
	20x80	11		30	20	9480HC	12,30	250	4000
	21x70	11	5,6	23	15	94570HC	14,30	250	2000
5	21x80	12		30	18	94580HC	15,10	250	2000
	21x90	13		37	20	94590HC	16,70	200	1600
	21x100	14,5		40	22	945100HC	19,00	100	800
	22x90	13	6,2	35	20	9590HC	20,80	100	800
	22x120	16		55	30	95120HC	28,90	100	800

Clavos acero CPQ



Características

Pensados para el profesional de la construcción

- Clavo Tenaz. Especial dureza para garantizar una introducción rápida.
- Clavo con Temple. Su especial templado y cementado permite, si se desea, un doblado del clavo de hasta 90 grados.
- Clavo Seguro. Los clavos no se parten, por lo tanto se evita el riesgo de daño si salta la pieza rota.
- Clavo con Cabeza. Cabeza más ancha para facilitar su introducción y su extracción mediante palanca.
- Clavo Garantizado. Por el fabricante europeo de mayor prestigio "Don Quichotte".

CPQ		Precios	
Denom.	d _s [mm]	Código	Precio €/100 u.
2,5	2,5x20	92520CPQ	14,80
	2,5x25	92525CPQ	16,00
	2,5x30	92530CPQ	17,50
	2,5x40	92540CPQ	20,80
	2,5x50	92550CPQ	24,30
3	3x60	9360CPQ	8,20
3,4	3,4x25	93425CPQ	8,20
	3,4x30	93430CPQ	8,20
	3,4x35	93435CPQ	8,60
	3,4x40	93440CPQ	8,60
	3,4x50	93450CPQ	9,30
	3,4x60	93460CPQ	10,90
	3,4x70	93470CPQ	12,10
	3,4x80	93480CPQ	14,40



Brocas y puntas de atornillar

Broca standard BST	348
Broca cilíndrica súper BSU	348
Broca SDS Plus	348
Puntas de atornillador PH (Philips)	349
Puntas de atornillar PZ (Pozi)	349
Puntas de atornillar TORX Plus®	349
Puntas de atornillar TORX®	350
Puntas de atornillar SIT	350
Puntas de atornillar inviolable TORX	350
Punta atornillar métrica PH2	351
Llave de vaso hexagonal LV	351
Adaptador magnético DPTOR	351
Remache cabeza alomada RS	352
Remachadora R1	352

Broca standard **BST**



Características

- Punta de metal duro.
- Para portabrocas universal.
- El diseño de la hélice facilita la extracción del polvo, y minimiza el calentamiento.
- Adecuada para el taladrar hormigón, mampostería y piedra natural y para el taladrado rotativo en mármol.



BST			Precios		Envase	Embalaje
Denom.	d _s [mm]	L _s [mm]	Código	Precio €/u.	 (Uds)	 (Uds)
4	4x75	40	475BST	3,10	1	20
5	5x85	40	585BST	3,10	1	20
6	6x100	55	6100BST	3,30	1	20
8	8x120	70	8120BST	4,30	1	20
10	10x120	70	10120BST	6,10	1	20
12	12x150	90	12150BST	7,90	1	20

Broca cilíndrica súper **BSU**



Características

- Punta de metal duro.
- Para portabrocas universal.
- El diseño de la hélice facilita la extracción del polvo, y minimiza el calentamiento.
- Adecuada para el taladrar hormigón, mampostería y piedra natural y para el taladrado rotativo en mármol.

BSU			Precios		Envase	Embalaje
Denom.	d _s [mm]	L _s [mm]	Código	Precio €/u.	 (Uds)	 (Uds)
5	5x85	40	585BSU	7,20	1	20
6	6x100	55	6100BSU	7,30	1	20
8	8x120	70	8120BSU	9,00	1	20
10	10x120	70	10120BSU	12,20	1	20

Broca **SDS Plus**



Características

- Punta biselada de metal duro de larga duración.
- El diseño permite mejor centrado y evita roturas en caso de impacto.
- El diseño de la hélice facilita la extracción del polvo, y minimiza el calentamiento.
- Broca de percusión para martillos electroneumáticos de inserción directa.
- Adecuada para el taladrar hormigón, mampostería y piedra natural y para el taladrado rotativo en mármol.

SDS Plus			Precios		Envase
Denom.	d _s [mm]	L _s [mm]	Código	Precio €/u.	 (Uds)
5	5x110	50	5110BSDS	13,80	1
6	6x110		6110BSDS	13,80	1
8	8x110		8110BSDS	13,80	1
	8x160	100	8160BSDS	17,80	1
10	10x110		10110BSDS	15,20	1
	10x160		10160BSDS	19,00	1
12	12x160		12160BSDS	23,10	1
14	14x166		14166BSDS	29,50	1
22	22x450	400	22450BSDS	134,40	1
25	25x450		25450BSDS	172,30	1

Puntas de atornillar PH (Philips)

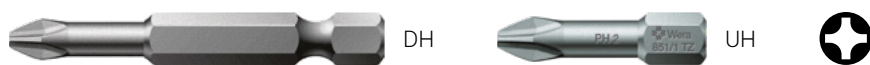

PH Philips			Precios		Envase	Embalaje
Ø	Ref.	Para tornillos	Código	Precio €/u	(Uds)	(Uds)
UH 1/4"x25	PH1	2,2-3	9UH1	3,00	1	10
	PH2	3,3-5	9UH2	3,00	1	10
	PH3	5,5-7	9UH3	3,00	1	10
DH 1/4"x50	PH1	2,2-3	9DH1	5,20	10	100
	PH2	3,3-5	9DH2	5,20	10	10
	PH3	5,5-7	9DH3	5,20	10	10

Puntas de atornillar PZ (Pozi)

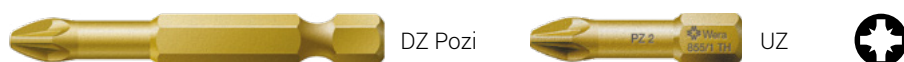

PZ Pozi			Precios		Envase	Embalaje
Ø	Ref.	Para tornillos	Código	Precio €/u	(Uds)	(Uds)
UZ 1/4"x25	PZ1	2,2-3	9UZ1	3,00	1	80
	PZ2	3,3-5	9UZ2	3,00	1	80
	PZ3	5,5-7	9UZ3	3,00	1	10
DZ 1/4"x50	PZ1	2,2-3	9DZ1	5,50	10	10
	PZ2	3,3-5	9DZ2	5,50	10	80
	PZ3	5,5-7	9DZ3	5,50	10	10

Puntas de atornillar TORXplus®



TXPLUS Puntas atornillar			Precios		Envase	Embalaje
Ø	Ref.	Para tornillos	Código	Precio €/u	(Uds)	(Uds)
UTXP 1/4"x25	TX6	2,1-2,3	9UTXP6	15,00	1	80
	TX7	2,3-2,6	9UTXP7	15,00	1	10
	TX8	2,5-3	9UTXP8	15,00	1	80
DZ 1/4"x50	TX6	2,1-2,3	9DTPX6	31,00	10	80
	TX7	2,3-2,6	9DTPX7	31,00	10	10
	TX8	2,5-3	9DTPX8	31,00	10	10

Puntas de atornillar TORX®



TX Puntos atornillar			Precios		Envase	Embalaje
∅	Ref.	Para tornillos	Código	Precio €/u	(Uds)	(Uds)
UTX 1/4"x25	TX10	3-35	9UTX10	5,00	1	10
	TX15	3,5-3,9	9UTX15	5,00	1	10
	TX20	4-4,5	9UTX20	5,00	1	80
	TX25	4,8-5,5	9UTX25	5,00	1	80
	TX30	5,5-6,3	9UTX30	5,00	1	10
	TX40	6,3-10	9UTX40	5,00	1	80
DTX 1/4"x26	TX50	12	9UTX50	9,40	1	50
	TX10	3-35	9DTX10	11,70	10	10
	TX15	3,5-3,9	9DTX15	11,70	10	10
	TX20	4-4,5	9DTX20	11,70	10	80
	TX25	4,8-5,5	9DTX25	11,70	10	80
	TX30	5,5-6,3	9DTX30	11,70	10	80

Puntas de atornillar sit



SIT Puntas atornillar			Precios		Envase	Embalaje
∅	Ref.	Para tornillos	Código	Precio €/u	(Uds)	(Uds)
USIT 1/4"x25	SIT10	3-35	9USIT10	5,70	1	80
	SIT20	4-4,5	9USIT20	5,70	1	10
	SIT25	4,8-5,5	9USIT25	5,70	1	140
	SIT30	5,5-6,3	9USIT30	5,70	1	10
	SIT40	7-7,5	9USIT40	5,70	1	10

SIT Puntas atornillar en blister			Precios		Envase	Embalaje
∅	Ref.	Para tornillos	Código	Precio €/blister	(Uds)	(Uds)
USIT 1/4"x25	SIT10	3-35	7USIT10	5,90	1	80
	SIT20	4-4,5	7USIT20	5,90	1	80
	SIT25	4,8-5,5	7USIT25	5,90	1	80
	SIT30	5,5-6,3	7USIT30	5,90	1	80
	SIT40	7-7,5	7USIT40	5,90	1	80

Puntas de atornillar inviolable TORX®



TX Inviolable Puntas atornillar			Precios		Envase	Embalaje
∅	Ref.	Para tornillos	Código	Precio €/u	(Uds)	(Uds)
UTXI 1/4"x50	TX20I	4-4,5	9UTX20I	7,30	10	10

Punta atornillar métrica PH2



M5 (LH) y
M10/32



PH2 Puntas atornillar			Precios		Envase	Embalaje
∅	Para tornillos	"a	Código	Precio €/u.	(Uds)	(Uds)
PH2x33 M5	PH2	M5	933M5H2	40,70	1	5
PH2x45 M5	PH2	M5	945M5H2	39,90	5	5
PH2x45 M10/32	PH2	M10/32"	9B45M10/32H2	39,60	5	5
PZ2x33 M5	PZ2	M5	9M5Z2	25,90	1	10

Llave de vaso hexagonal LV



Características

- Hexagonal.
- Magnéticas.

LV Puntas atornillar		Precios		Envase
∅	Para tornillos	Código	Precio €/u.	(Uds)
SW5,5	3-3,5	9LVG55	19,90	5
SW6	3,5-3,9	9LVG6	19,90	5
SW7	3,9-4,5	9LVG7	19,90	5
SW8	4,8-5,5	9LVG8	19,90	5
SW10	5,5-6,3	9LVG10	23,50	5
SW13	6,3	9LVG13	23,50	5

Adaptador magnético DPTOR

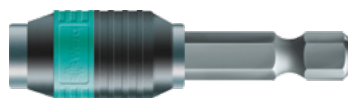

DPTOR



PMW

Características

- Para 1/4".
- Magnética.

DPTOR				Precios		Envase
∅	Para tornillos	"a	d _h [mm]	Código	Precio €/u.	(Uds)
1/4"	3-3,5	1/4"	50	9PM50	20,60	5
1/4"	3,5-3,9	1/4"	75	9PM75	28,00	5
1/4"	3-3,5	1/4"	100	9PM100	40,30	5
1/4"	3,9-4,5	1/4"	50	9DPTOR	49,70	5

Remache cabeza alomada **RS**



RS Remaches			Precios		Envase	Embalaje
∅	Ref.	"a	Código	Precio €/100 u.	(Uds)	(Uds)
3,2	6	1,5-3,5	9SA326RS	5,80	1000	8000
4	8	3-5	9SA48RS	6,60	500	4000
	10	5-7	9SA410RS	7,30	500	4000
	12	7-9	9SA412RS	8,70	500	4000
	15	9-15	9SA415RS	11,20	500	4000
	18	12-15	9SA418RS	12,10	500	4000
4,8	8	3-4,5	9SA488RS	8,20	500	4000
	10	4,5-6	9SA4810RS	9,20	500	4000
	12	6-8	9SA4812RS	10,40	500	4000
	16	10-12	9SA4816RS	13,50	250	2000
	18	12-14	9SA4818RS	14,90	250	2000

Remachadora **R1**

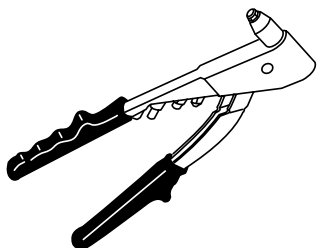

R1	Precios		Envase	Embalaje
∅	Código	Precio €/u.	(€/u)	(Uds)
R1	R1	93,20	1	4

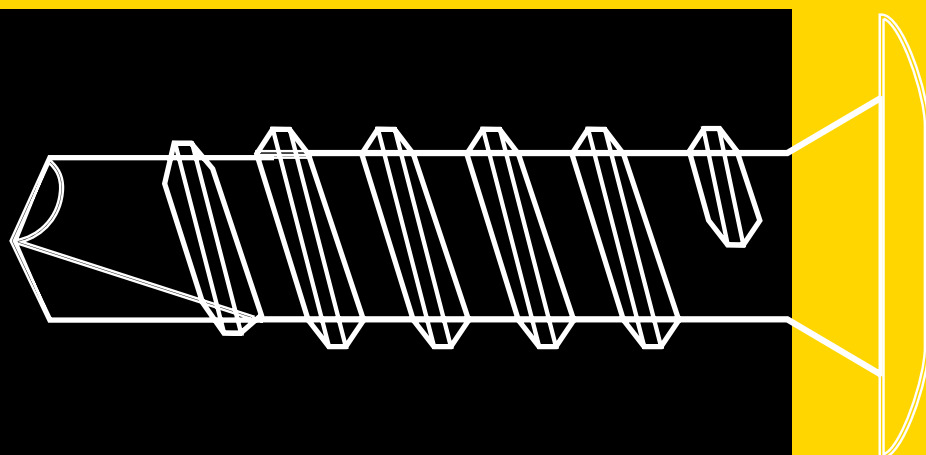

Autoservicio fijación

Blister auto-didáctico



Medidas: 76 de ancho x 143 ó 192 ó 233 de largo.

Clara explicación de aplicación

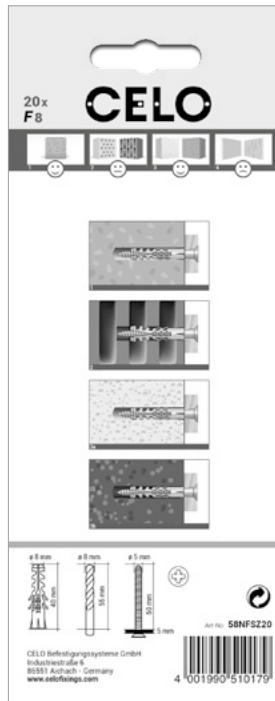







Orificio según norma Europea

El sistema de guía de color y los emoticonos muestran la facilidad de uso en diferentes materiales de construcción, de forma rápida y sencilla.

En la parte de atrás encontrarás información importante sobre el montaje y los datos técnicos del producto.

Código de color para una fácil elección

Tipo Material	 Piedra maciza	 Ladrillo macizo	 Ladrillo perforado	 Ladrillo silicio-calcico	 Hormigón poroso	 Hormigón	 Placa de cartón-yeso
Para materiales macizos y mampostería					-	-	-
Para todos los materiales							
Para materiales prefabricados y fijación en hueco	-	-	-	-	-	-	-
Para hormigón	-	-	-	-	-	-	-

Taco nylon FX



FX					Precios		Envasado		
Nombre	d _o [mm]	L [mm]	d _s [mm]	L _s [mm]	Código	€/Blister	Blister (uds)	(blister)	EAN 13 code
FX5	5	25	2,5-4,0	34+da	55FX50	5,20	50	10	4250438901455
FX6	6	30	3,5-5,0	45+da	56FX30	5,20	30	10	4250438901462
FX8	8	40	4,5-6,0	54+da	58FX20	5,20	20	10	4250438901479
FX10	10	50	6,0-8,0	67+da	510FX10	5,20	10	10	4250438901486
FX12	12	60	8,0-10,0	81+da	512FX6	5,20	6	10	4250438901493

d_s = espesor a fijar



FX					Precios		Envasado		
Nombre	d _o [mm]	L [mm]	d _s x L _s [mm]	Tipo	Código	€/Blister	Blister (uds)	(blister)	EAN 13 code
FX5SZ	5	25	3,5-35		55FXSZ20	6,00	20	10	4250438901509
FX6SZ	6	30	4,5-45		56FXSZ15	6,00	15	10	4250438901516
FX8SZ	8	40	5,0-60		58FXSZ10	6,00	10	10	4250438901523
FX10K	10	50	7,0-65		510FXX5	6,00	5	10	4250438901530
FX12K	12	60	8,0-80		512FXX2	6,00	2	10	4250438901547

Taco nylon F



F					Precios		Envasado		
Nombre	d _o [mm]	L [mm]	d _s [mm]	L _s [mm]	Código	€/Blister	Blister (uds)	(blister)	EAN 13 code
NF 4	4	20	2,0-3,0	23 tfix	54NF20	2,60	20	10	4001990498132
NF 5	5	25	2,5-4,0	29 tfix	55NF20	2,60	20	10	4001990498149
NF 6	6	30	3,5-5,0	35 tfix	56NF20	2,60	20	10	4001990498156
NF 7	7	30	4,0-5,5	36 tfix	57NF20	2,60	20	10	4001990498163
NF 8	8	40	4,5-6,0	46 tfix	58NF20	2,60	20	10	4001990498170
NF 10	10	50	6,0-8,0	58 tfix	510NF5	2,60	5	10	4001990498187
NF 12	12	60	8,0-10,0	70 tfix	512NF5	2,60	5	10	4001990498194

Taco con tornillo / alcayata / hembrilla F



F	Nombre	d _o [mm]	L [mm]	d _s x L _s [mm]	Tipo	Precios		Envasado		
						Código	€/Blister	Blister (uds)	Envasado (blister)	EAN 13 code
	F4 SZ	4	20	3,0-25		54NFSZ20	4,70	20	10	4001990498231
	F5 SZ	5	25	3,0-35		55NFSZ20	4,70	20	10	4001990498248
	F6 SZ	6	30	4,0-40		56NFSZ20	4,70	20	10	4001990498255
	F6 WH	6	30	4,2-40		56NFWH5	4,70	5	10	4001990497609
	F6 RH	6	30	4,2-65		56NFRH5	4,70	5	10	4001990497623
	F8 K	8	40	5,0-50		58NFK5	4,70	5	10	4001990498262
	F8 WH	8	40	5,0-50		58NFWH5	4,70	5	10	4001990497616
	F8 RH	8	40	5,4-80		58NFRH5	4,70	5	10	4001990497630
	F8 SZ	8	40	5,0-50		58NFSZ20	4,70	20	10	4001990490179
	F10 K	10	50	7,0-65		510NFK5	4,70	5	10	4001990498279
	F12 K	12	60	8,0-80		512NFK2	4,70	5	10	4001990498286

Taco de golpe NP



NP	Nombre	d _o [mm]	L [mm]	d _s [mm]	Tipo	Precios		Envasado		
						Código	€/Blister	Blister (uds)	Envasado (blister)	EAN 13 code
	NP5-35	5	35	3,5		5535NP20	6,90	20	10	4001990503393
	NP5-50	5	50	3,5		5550NP20	6,90	20	10	4001990502730
	NP6-40	6	40	4,0		5640NP15	6,90	15	10	4001990502761
	NP6-60	6	60	4,0		5660NP15	6,90	15	10	4001990502792
	NP6-80	6	80	4,0		5680NP10	6,90	10	10	4001990500736
	NP8-60	8	60	5,0		5860NP10	6,90	10	10	4001990500743
	NP8-80	8	80	5,0		5880NP10	6,90	10	10	4001990500750
	NP8-100	8	100	5,0		58100NP10	6,90	10	10	4001990500767
	NP8-120	8	120	5,0		58120NP5	6,90	5	10	4001990500774
	NP8-135	8	135	5,0		58135NP5	6,90	5	10	4001990500781

Taco extralargo FL



FL					Precios		Envasado		
	Nombre	do [mm]	L [mm]	ds [mm]	Ls [mm]	Código	€/Blister	Blister (uds)	Blister (blister)
FL6-60	6	60	3,5-4,5	65+fix	5660FL10	5,10	10	10	4001990497647
FL8-80	8	80	4,5-5,5	85+fix	5880FL10	5,10	10	10	4001990497654
FL10-90	10	90	6,0-7,0	100+fix	51090FL5	5,10	5	10	4001990497661

da = espesor a fijar.

Tornillo de fijación directa a premarco FBS



FBS					Precios		Envasado		
	Nombre Ø-L	d ₀ [mm]	h ₁ ≥ [mm]	h _{nom} ≥ [mm]	d ₁ [mm]	Código	€/Blister	Blister (uds)	Blister (blister)
FBS 7,5-112	6	6	dependiendo del material donde se instala, h _{nom} + 10 mm	dependiendo del material donde se instala, ver tabla Pág. 149	6,2	575112FBS6	6,30	6	10
FBS 7,5-132	6	6			6,2	575132FBS6	5,90	6	10
FBS 7,5-152	6	6			6,2	575152FBS6	7,20	6	10

Incluye tapones: 6 blancos / 6 marrones.

Taco multimaterial MFR



SB TX, galv. / A4 / HD

SB SSKS, galv. / A4 / HD

FB SSKS, galv. / A4 / HD



MFR SB TX Cincado	Precios		Envase	Embalaje	Embalaje
Ø [mm]	Código	Precio €/Blister	(Uds)	(Bolsas)	(Uds)
8	5860MFRST4	4,60	4	10	40
8	5880MFRST4	5,60	4	10	40
10	51060MFRST4	5,80	4	10	40
10	51080MFRST4	6,40	4	10	40
10	510100MFRST4	7,00	4	10	40
10	510115MFRST4	7,70	4	10	40
10	510135MFRST4	10,40	4	10	40
10	510160MFRST4	11,60	4	10	40

MFR SB SSKS Cincado	Precios		Envase	Embalaje	Embalaje
Ø [mm]	Código	Precio €/Blister	(Uds)	(Bolsas)	(Uds)
8	5860MFRSB4	4,90	4	10	40
10	51080MFRSB4	6,60	4	10	40
10	510100MFRSB4	7,60	4	10	40
10	510115MFRSB4	8,30	4	10	40
10	510135MFRSB4	10,50	4	10	40
10	510160MFRSB4	11,80	4	10	40

MFR FB SSKS Cincado	Precios		Envase	Embalaje	Embalaje
Ø [mm]	Código	Precio €/Blister	(Uds)	(Bolsas)	(Uds)
8	5880MFRFB4	5,80	4	10	40
10	51060MFRFB4	5,90	4	10	40

Taco multimaterial sin collarin MZ



MZ					Precios		Envasado		
Nombre	d _o [mm]	L [mm]	d _s [mm]	L [mm]	Código	€/Blister	Blister (uds)	(blister)	EAN 13 code
MZ6	6	29	3,0-4,5	34+fix	56MZ20	4,40	20	10	4001990510728
MZ6-40	6	40	3,0-4,5	45+fix	5640MZ10	4,40	10	10	4001990510735
MZ8	8	48	3,5-6,0	54+fix	58MZ15	4,40	15	10	4001990510742
MZ10	10	59	6,0-8,0	67+fix	510MZ10	4,40	10	10	4001990510759
MZ12	12	71	8,0-10,0	81+fix	512MZ5	4,40	5	10	4001990510766

d_s = espesor a fijar.



MZ					Precios		Envasado		
Nombre	d _o [mm]	L [mm]	d _s x L _s [mm]	Tipo	Código	€/Blister	Blister (uds)	(blister)	EAN 13 code
MZ6 SPS	6	29	4,5-40		56MZSZ20	5,60	20	10	4001990510773
MZ6-40 SPS	6	40	4,5-50		5640MZSZ10	5,60	10	10	4001990510780
MZ8 SPS	8	48	5,0-70		58MZSZ8	5,60	8	10	4001990510797

Taco multimaterial con collarín **MZK**



MZK					Precios		Envasado		
Nombre	d _o [mm]	L [mm]	d _s [mm]	L _s [mm]	Código	€/Blister	Blister (uds)	Blister (blister)	EAN 13 code
MZK6	6	30	3,0-4,5	34+fix	56MZK20	4,40	20	10	4001990497678
MZK6-41	6	41	3,0-4,5	45+fix	5641MZK10	4,40	10	10	4001990497685
MZK8	8	49	3,5-6,0	54+fix	58MZK15	4,40	15	10	4001990497692
MZK10	10	60	6,0-8,0	67+fix	510MZK10	4,40	10	10	4001990497609



MZK					Precios		Envasado		
Nombre	d _o [mm]	L [mm]	d _s x L _s [mm]	Tipo	Código	€/Blister	Blister (uds)	Blister (blister)	EAN 13 code
MZK6 SPS	6	30	4,5-40		56MZKSZ20	5,60	20	10	4001990498316
MZK6-41 SPS	6	41	4,5-50		5641MZKSZ10	5,60	10	10	4001990498323
MZK6-41 WH	6	41	4,4-69		5641MZKWH5	5,60	5	10	4001990498354
MZK6-41 RH	6	41	4,5-68		5641MZKRH5	5,60	5	10	4001990498378
MZK8 SPS	8	49	5,0-70		58MZKSZ8	5,60	8	10	4001990498330
MZK8 WH	8	49	5,0-70		58MZKWH5	5,60	5	10	4001990498361
MZK8 RH	8	49	5,0-86		58MZKRH5	5,60	5	10	4001990498385
MZK10 SK	10	60	7,0-80		510MZKK5	5,60	5	10	4001990498347

Taco para cartón yeso con tornillo HR



HR					Precios		Envasado		
Nombre	d _o [mm]	L [mm]	d _s x L _s [mm]	Tipo	Código	€/Blister	Blister (uds)	Envasado (blister)	EAN 13 code
HR6 SPS	6	30	3,5-50		56HRSZ20	4,60	20	10	4001990500903
HR8 SPS	8	40	4,0-60		58HRSZ20	4,60	20	10	4001990500910

Basculante FK S / FK HS



FK				Precios		Envasado		
Nombre	Rosca (M)	L [mm]	Tipo	Código	€/Blister	Blister (uds)	Envasado (blister)	EAN 13 code
FK3-90 S	M3	90		5390FKS2	5,10	2	10	4001990503638
FK4-95 S	M4	95		5495FKS2	5,10	2	10	4001990503645
FK3-85 HS	M3	85		5385FKHS2	5,10	2	10	4001990503652
FK4-100 HS	M4	100		54100FKHS2	5,10	2	10	4001990503669

Taco metálico para cartón yeso con tornillo GKDZ



GKDZ				Precios		Envasado		
Nombre	L [mm]	d _s [mm]	Tipo	Código	€/Blister	Blister (uds)	Envasado (blister)	EAN 13 code
GKDZ 4-5 SPS	37	4,5		537GKDZSZ6	5,20	6	10	4250438933432

Taco nylon para cartón yeso GKD



GKD				Precios		Envasado		
Nombre	L [mm]	d _s [mm]	L _s [mm]	Código	€/Blister	Blister (uds)	(blister)	EAN 13 code
GKD	35	4-4,5	22+fix	5GKD10	5,20	10	10	4250438901554



Taco nylon para cartón yeso con tornillo GKDPZ



GKDPZ				Precios		Envasado		
Nombre	L [mm]	d _s [mm]	L _s [mm]	Código	€/Blister	Blister (uds)	(blister)	EAN 13 code
GKD	35	4	40	5GKDPZ6	5,20	6	10	4250438901561



Fijación para hueco con tornillo BT Plus

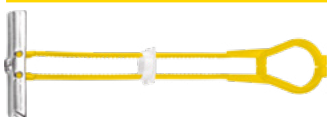

BT					Precios		Envasado		
Nombre	d _s x L _s	d _o [mm]	T _{fix} [mm]	Impronta	Código	€/Blister	Blister (uds)	(blister)	EAN 13 code
BT	M4x50	13	10-70	PZ2+ranura	54BTLO4	6,30	4	10	4250438902452
BT	M5x62	13	10-70	PZ2+ranura	55BTLO4	6,50	4	10	4250438902469
BT	M6x62	13	10-70	PZ2+ranura	56BTLO4	7,00	4	10	4250438902476

Taco de latón ME

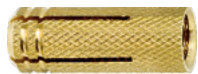

ME				Precios		Envasado		
Nombre	d _o [mm]	Rosca [mm]	L [mm]	Código	€/Blister	Blister (uds)	Blister (blister)	EAN 13 code
ME6	8	M6	23	5L6ME5	5,60	5	10	4001990500880
ME8	10	M6	30	5L8ME4	5,60	4	10	4001990500897

Anclaje metálicos espárrago homologado CE BA plus



BA plus			Precios		Envasado		
Nombre	d _o [mm]	L [mm]	Código	€/Blister	Blister (uds)	Blister (blister)	EAN 13 code
BA8-85	8	85	5885BA2	6,10	2	10	4001990500798
BA10-90	10	90	51090BA2	7,40	2	10	4001990502198
BA10-120	10	120	510120BA2	10,20	2	10	4001990502808

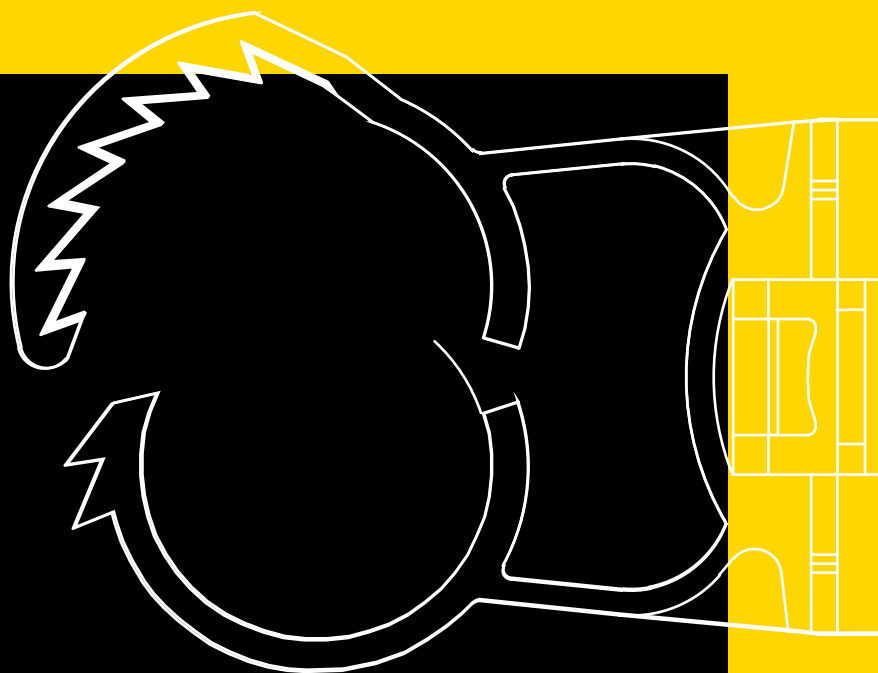

Autoservicio sujeción



HOMOLOGACIÓN
kiwa
Partner for progress



AN	Precio		Envasado			
	Denom.	Código	€/Bolsa	(uds)	Bolsas	EAN 13 code
	AN 15-16	115AN	4,60	10	15	8421814394253
	AN 18-20	118AN	5,60	10	15	8421814422925
	AN 22-25	122AN	6,20	10	15	8421814422932
	AN 26-28	126AN	4,40	6	15	8421814394284
	AN 30-32	130AN	6,00	6	15	8421814394291



HOMOLOGACIÓN
kiwa
Partner for progress



ABM	Precio		Envasado			
	Denom.	Código	€/Bolsa	(uds)	Bolsas	EAN 13 code
	ABM 14-18	18ABM	3,20	5	15	8421814395809
	ABM 20-25	25ABM	3,50	5	15	8421814395816
	ABM 25-32	32ABM	4,40	5	15	8421814395823



HOMOLOGACIÓN
kiwa
Partner for progress





ABT	Precio		Envasado			
	Denom.	Código	€/Bolsa	(uds)	Bolsas	EAN 13 code
	ABT-14/18	18ABT	4,00	6	15	8421814523301
	ABT-20/25	25ABT	4,90	6	15	8421814523325
	ABT-25/32	32ABT	6,00	6	15	8421814523349
	ABT-35/42	40ABT	8,10	6	15	8421814523363





MC	Precio		Envasado			
	Denom.	Código	€/Bolsa	(uds)	Bolsas	EAN 13 code
	MC 16	16MC	5,10	10	15	8421814421577
	MC 18	18MC	6,00	6	15	8421814422765
	MC 20	20MC	6,20	6	15	8421814422772
	MC 25	25MC	7,80	6	15	8421814422789



SC	Precio			Envasado		
	Denom.	Código	€/Bolsa	 (uds)	 Bolsas	EAN 13 code
	SC 12	112SC	6,20	10	15	8421814394031
	SC 15	115SC	6,60	10	15	8421814394048
	SC 18	118SC	7,80	10	15	8421814422987
	SC 22	122SC	8,20	10	15	8421814422994
	SC 28	128SC	8,90	10	15	8421814423007





SCD	Precio			Envasado		
	Denom.	Código	€/Bolsa	 (uds)	 Bolsas	EAN 13 code
	SCD 12	112SCD	10,20	10	15	8421814394109
	SCD 15	115SCD	11,10	10	15	8421814394116
	SCD 18	118SCD	12,80	10	15	8412814394123
	SCD 22	122SCD	13,70	10	15	8421814394130
	SCD 28	128SCD	14,90	10	15	8421814416528





NK	Precio			Envasado			
	Denom.	Bricromatada	Zincada	 (uds)	 Bolsas	EAN 13 code	
		Código	Código				€/Bolsa
	NK 12	B12NK	-	2,40	5	15	8421814407854
	NK 15	B15NK	-	2,50	5	15	8421814407861
	NK 16	-	16NK	2,40	5	15	8421814434263
	NK 18	B18NK	-	2,50	5	15	8421814407885
	NK 20	-	20NK	2,50	5	15	8421814434270
	NK 22	B22NK	-	2,60	5	15	8421814407908
	NK 25	-	25NK	3,60	5	15	8421814434287
	NK 28	B28NK	-	4,40	10	15	8421814407922
	NK 32	-	32NK	2,90	5	15	8421814434294
	NK 40	-	40NK	3,50	6	15	8421814434300



L M6	Precio			Envasado			
	Denom.	Bricromatada Código	Zincada Código	€/Bolsa	 (uds)	 Bolsas	EAN 13 code
	L 28	B28L		3,80	10	15	8421814393867
	L 35	B35L		2,60	5	15	8421814395724
	L 42	B42L		3,20	5	15	8421814395731
	L 50		50L	3,40	6	15	8421814434317
	L 55	B55L		4,40	5	15	8421814395755



LI M6		Precio		Envasado		
Denom.	Código	€/Bolsa	 (uds)	 Bolsas	EAN 13 code	
LI 12	B12LI	2,60	5	15	8421814407736	
LI 15	B15LI	2,90	5	15	8421814407731	
LI 18	B18LI	3,20	5	15	8421814407748	
LI 22	B22LI	3,30	5	15	8421814407755	
LI 28	B28LI	3,40	5	15	8421814395762	
LI 35	B35LI	4,40	5	15	8421814395779	
LI 42	B42LI	4,70	5	15	8421814395786	



AD		Precio		Envasado		
Denom.	Código	€/Bolsa	 (uds)	 Bolsas	EAN 13 code	
LD 12	B12AD	4,50	10	15	8421814393850	
LD 15	B15AD	4,50	10	15	8421814393966	
LD 18	B18AD	5,00	10	15	8421814393965	
LD 22	B22AD	6,30	10	15	8421814393942	
LD 28	B28AD	7,80	10	15	8421814395953	



GNK Tirafondo M6x30 incorporado		Precio		Envasado		
Denom.	Código	€/Bolsa	 (uds)	 Bolsas	EAN 13 code	
GNK 15	N15GNK	6,10	10	15	8421814407960	
GNK 18	N18GNK	6,20	10	15	8421814407977	
GNK 22	N22GNK	7,00	10	15	8421814407984	



R	Precio		Envasado			
	Denom.	Código	€/Bolsa	(uds)	Bolsas	EAN 13 code
	R 18+M8X80+FX10	18REDRN	3,80	2	15	8421814528351
	R 22+M8X80+FX10	22REDRN	4,10	2	15	8421814408004
	R 28+M8X80+FX10	28REDRN	4,30	2	15	8421814408011
	R 35+M8X80+FX10	35REDRN	4,40	2	15	8421814408028
	R 40+M8X80+FX10	40REDRN	4,40	2	15	8421814408035
	R 50+M8X80+FX10	50REDRN	4,70	2	15	8421814408042
	R 60+M8X80+FX10	60REDRN	5,10	2	15	8421814408059
	R 75+M8X80+FX10	75REDRN	6,10	2	15	8421814408066
	R 90+M10X100+FX12	90REDRN	8,70	2	15	8421814410311
	R 110+M10X100+FX12	110REDRN	9,30	2	15	8421814410328
	R 125+M10X100+FX12	125REDRN	9,80	2	15	8421814435635
	R 140+M10X100+FX12	140REDRN	10,70	2	15	8421814410335
	R 160+M10X100+FX12	160REDRN	11,60	2	15	8421814435642



RI	Precio		Envasado			
	Denom.	Código	€/Bolsa	(uds)	Bolsas	EAN 13 code
	RI 18+M8X80+FX10	18RIEDRN	5,00	2	15	8421814528337
	RI 22+M8X80+FX10	22RIEDRN	5,60	2	15	8421814408004
	RI 28+M8X80+FX10	28RIEDRN	5,80	2	15	8421814408011
	RI 35+M8X80+FX10	35RIEDRN	6,10	2	15	8421814408028
	RI 40+M8X80+FX10	40RIEDRN	7,20	2	15	8421814408035
	RI 50+M8X80+FX10	50RIEDRN	7,30	2	15	8421814408042
	RI 60+M8X80+FX10	60RIEDRN	7,70	2	15	8421814408059
	RI 75+M8X80+FX10	75RIEDRN	8,70	2	15	8421814408066
	RI 90+M10X100+FX12	90RIEDRN	12,30	2	15	8421814410311
	RI 110+M10X100+FX12	110RIEDRN	13,70	2	15	8421814410328
	RI 140+M10X100+FX12	140RIEDRN	15,40	2	15	8421814410335



D	Precio		Envasado			
	Denom.	Código	€/Unid.	(uds)	Bolsas	EAN 13 code
	D90	90D	2,10	1	50	8421814422673
	D110	110D	2,40	1	50	8421814422635
	D125	125D	2,60	1	50	8421814422611
	D160	160D	3,50	1	50	8421814422659
	D200	200D	4,40	1	50	8421814422642





SF	Precio		Envasado			
	Denom.	Código	€/Bolsa	(uds)	Bolsas	EAN 13 code
	SF 10-17	10SF	5,10	6	15	8421814393904
	SF 15-25	15SF	5,70	6	15	8421814393911
	SF 20-32	20SF	5,80	6	15	8421814436175
	SF 25-45	25SF	6,10	6	15	8421814393928
	SF 32-50	32SF	8,40	6	15	8421814528191
	SF 40-60	40SF	3,60	2	15	8421814093989





Grapa F	Precio		Envasado			
	Denom.	Código	€/Bolsa	(uds)	Bolsas	EAN 13 code
	F16	16F	3,20	20	15	8421814393034
	F18	18F	3,20	20	15	8421814393041
	F20	20F	3,50	20	15	8421814393058
	F22	22F	3,20	15	15	8421814393065
	F25	25F	3,40	15	15	8421814393072
	F28	28F	3,70	15	15	8421814393089
	F32	32F	4,90	15	15	8421814393096
	F40	40F	3,20	6	15	8421814393102





U		Precio		Envasado		
Denom.	Código	€/Bolsa	 (uds)	 Bolsas	EAN 13 code	
U-16	16U	3,60	12	15	8421814523202	
U-20	20U	3,80	12	15	8421814523226	
U-25	25U	3,50	6	15	8421814523240	
U-32	32U	4,50	6	15	8421814523264	
U-40	40U	3,40	4	15	8421814523288	





FTS		Precio		Envasado		
Denom.	Código	€/Bolsa	 (uds)	 Bolsas	EAN 13 code	
FTS 18	18FTS	4,60	6	15	8421814421669	
FTS 22	22FTS	5,00	6	15	8421814421676	





FTD		Precio		Envasado		
Denom.	Código	€/Bolsa	 (uds)	 Bolsas	EAN 13 code	
FTD 18	18FTD	6,10	6	15	8421814421683	
FTD 22	22FTD	6,20	6	15	8421814421690	





TCB		Precio		Envasado		
Denom.	Código	€/Bolsa	 (uds)	 Bolsas	EAN 13 code	
TCB 3-13	13TCB	6,60	20	15	8421814421607	
TCB 13-28	28TCB	4,30	10	15	8421814421614	



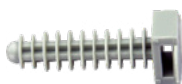

MPLG		Precio		Envasado		
Denom.	Código	€/Bolsa	 (uds)	 Bolsas	EAN 13 code	
PLASTIGRAP MULTIDIÁMETRO 4-6 mm	147MPLG	3,50	25	15	8421814523424	
PLASTIGRAP MULTIDIÁMETRO 7-9 mm	179MPLG	4,50	25	15	8421814523448	
PLASTIGRAP MULTIDIÁMETRO 10-14 mm	11014MPLG	7,40	25	15	8421814523400	





TB		Precio		Envasado		
Denom.	Código	€/Bolsa	 (uds)	 Bolsas	EAN 13 code	
TB 8	48TB	4,30	25	15	8421814393515	





BBA		Precio		Envasado		
Denom.	Código	€/Bolsa	 (uds)	 Bolsas	EAN 13 code	
BBA 19	119BBA	5,00	15	15	8421814523462	
BBA 28	128BBA	4,40	10	15	8421814523486	





BBT		Precio		Envasado		
Denom.	Código	€/Bolsa	 (uds)	 Bolsas	EAN 13 code	
BBT15	15BBT	5,00	20	15	8421814523509	
BBT19	19BBT	4,40	15	15	8421814523523	





ESP		Precio		Envasado		
Denom.	Código	€/Bolsa	 (uds)	 Bolsas	EAN 13 code	
M6x30	630ESP	1,60	10	15	8421814394192	



MSC		Precio		Envasado		
Denom.	Código	€/Bolsa	 (uds)	 Bolsas	EAN 13 code	
M6x30	630MSC	4,10	10	15	8421814394208	





MS		Precio		Envasado		
Denom.	Código	€/Bolsa	 (uds)	 Bolsas	EAN 13 code	
MS 6x30	630MS	6,30	10	15	-	
MS 8x30	830MS	6,30	10	15	-	
MS 10x30	1030MS	6,30	6	15	-	



TF		Precio		Envasado		
Denom.	Código	€/Bolsa	 (uds)	 Bolsas	EAN 13 code	
TF M6X30 Bicromatado	B630TF	2,50	10	15	8421814395878	
TF M6X44 Bicromatado	B644TF	2,70	10	15	8421814395885	
TF M8X40 Zincado	840TF	2,90	10	15	8421814524087	





Tirafondo + taco NF		Precio		Envasado		
Denom.	Código	€/Bolsa	 (uds)	 Bolsas	EAN 13 code	
TFN M6X30+N6	630TFN	3,50	18	15	8421814071291	
TFN M8X40+N8	840TFN	4,60	12	15	8421814421003	





EDR		Precio		Envasado		
Denom.	Código	€/Bolsa	 (uds)	 Bolsas	EAN 13 code	
EDR 8x60	860EDR	6,30	12	15	8421814433723	
EDR 8x80	880EDR	6,30	10	15	8421814433730	
EDR 8x100	8100EDR	6,30	8	15	8421814433716	
EDR 10x80	1080EDR	9,70	8	15	8421814433709	
EDR 10x100	10100EDR	9,70	6	15	8421814433686	
EDR 10x120	10120EDR	9,70	4	15	8421814433693	



AGRP		Precio		Envasado		
Denom.	Código	€/Bolsa	 (uds)	 Bolsas	EAN 13 code	
AGRP 4,2 x 13	4213AGRP	4,30	50	15	8421814523639	



TRBP+ Taco FX		Precio		Envasado		
Denom.	Código	€/Bolsa	 (uds)	 Bolsas	EAN 13 code	
Torab P M6 + FX 6	635TRBPFX	7,30	10	15	8421814523578	
Torab P M8 + FX 8	845TRBPFX	9,60	10	15	8421814523592	

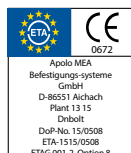

DT	Precio		Envasado		
	Código	€/Bolsa	(uds)	Bolsas	EAN 13 code
DT10L 10X80	1080DT	4,00	4	15	8421814433501
DT12C 12X70	1270DT	6,20	4	15	8421814433525
DT12L 12X100	12100DT	7,20	4	15	8421814433518



BA plus	Precio		Envasado		
	Código	€/Bolsa	(uds)	Bolsas	EAN 13 code
BA plus 8-135/70	8135BAP	6,30	4	15	8421814520829
BA plus 10-145/70	10145BAP	4,90	2	15	8421814520904
BA plus 12-150/50	12150BAP	7,40	2	15	8421814520980
BA plus 16-135/15	16135BAP	11,90	2	15	8421814521000
BA plus 16-150/30	16150BAP	12,80	2	15	8421814521024



SAPK	Precio		Envasado		
	Código	€/Bolsa	(uds)	Bolsas	EAN 13 code
SAPK 6	6SAPK	11,20	10	15	8421814518451
SAPK 8	8SAPK	11,20	8	15	8421814518475
SAPK 10	10SAPK	11,20	6	15	8421814518437



SH	Precio		Envasado		
	Código	€/Bolsa	(uds)	Bolsas	EAN 13 code
SH 12x60	1250TR	3,30	10	15	8421814394154
SH 15x85	1685TR	7,10	10	15	8421814394161



RESI AST espárrago	Precio		Envasado		
	Código	€/Bolsa	(uds)	Bolsas	EAN 13 code
RAST M8x100	8100VMASTP	8,60	4	15	8421814435659
RAST M10x130	10130VMASTP	11,20	4	15	8421814435666

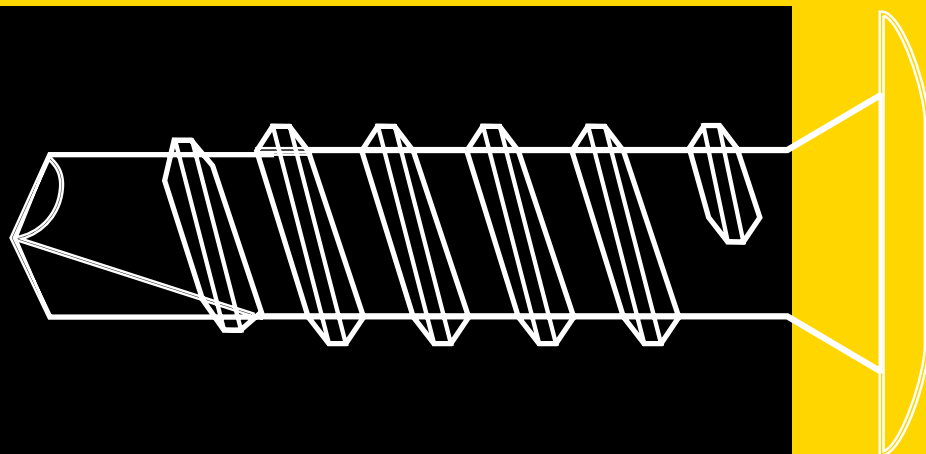

Autoservicio tornillería

Tapón adhesivo MTAP



Características

- **ADAPTABLE.** A todos los tornillos de cabeza avellanada.
- **PLANO.** No sobresale del mueble.
- **DURADERO.** No cae porque se adhiere a la madera o fórmica.
- **CÓMODO.** Fácil colocación.
- **INVISIBLE.** No se ve porque entona con cualquier madera o melamina. Diámetro 13 mm.

20 u.

Gama de Colores



Tornillo cabeza gota sebo BC



Características

- Punta broca N°3.
- Cabeza hexagonal.

Niquelado		Blister			Caja Profesional		
		Código	€/blister		Código	€/caja	
Ø	Longitud						
3,5	15	7Q3515BC	3,20	20	-	-	-
4	15	7Q415BC	3,20	20	4Q415BC	6,30	90
	17	7Q417BC	3,20	20	-	-	-

Pedido Mínimo: 10 Cajas Brico 10 Blisters por Medida.

Tornillo rosca madera

VELOX® PZ



Características

- Rosca lobular, lubricado.
- Cabeza avellanada.
- Pozi (PZ).

Bricromatado		Blister			Caja Profesional		
		Ø	Longitud	Código	€/blister	Paquetes	Código
3	15	7B315VLOX	3,20	60	4B315VLOX	6,30	230
	20	7B320VLOX	3,20	50	4B320VLOX	6,30	210
	25	7B325VLOX	3,20	40	4B325VLOX	6,30	190
3,5	15	7B3515VLOX	3,20	50	4B3515VLOX	6,30	210
	20	7B3520VLOX	3,20	45	4B3520VLOX	6,30	190
	25	7B3525VLOX	3,20	40	4B3525VLOX	6,30	170
	30	7B3530VLOX	3,20	35	4B3530VLOX	6,30	140
	35	7B3535VLOX	3,20	30	4B3535VLOX	6,30	115
	40	7B3540VLOX	3,20	30	4B3540VLOX	6,30	90
	45	7B3545VLOX	3,20	25	4B3545VLOX	6,30	65
4	15	7B415VLOX	3,20	40	4B415VLOX	6,30	155
	20	7B420VLOX	3,20	35	4B420VLOX	6,30	145
	25	7B425VLOX	3,20	30	4B425VLOX	6,30	130
	30	7B430VLOX	3,20	30	4B430VLOX	6,30	115
	35	7B435VLOX	3,20	25	4B435VLOX	6,30	100
	40	7B440VLOX	3,20	20	4B440VLOX	6,30	95
	45	7B445VLOX	3,20	20	4B445VLOX	6,30	75
	50	7B450VLOX	3,20	20	4B450VLOX	6,30	70
4,5	25	7B4525VLOX	3,20	25	4B4525VLOX	6,30	120
	30	7B4530VLOX	3,20	20	4B4530VLOX	6,30	95
	35	7B4535VLOX	3,20	20	4B4535VLOX	6,30	90
	40	7B4540VLOX	3,20	20	4B4540VLOX	6,30	75
	45	7B4545VLOX	3,20	15	4B4545VLOX	6,30	65
	50	7B4550VLOX	3,20	15	4B4550VLOX	6,30	55
	60	7B4560VLOX	3,20	10	4B4560VLOX	6,30	45
5	30	7B530VLOX	3,20	15	4B530VLOX	6,30	70
	35	7B535VLOX	3,20	15	4B535VLOX	6,30	65
	40	7B540VLOX	3,20	15	4B540VLOX	6,30	60
	50	7B550VLOX	3,20	10	4B550VLOX	6,30	50
	60	7B560VLOX	3,20	10	4B560VLOX	6,30	38
	70	7B570VLOX	3,20	10	4B570VLOX	6,30	30
	80	7B580VLOX	3,20	10	4B580VLOX	6,30	25
6	50	7B650VLOX	3,20	6	-	-	-
	60	7B660VLOX	3,20	6	-	-	-
	70	7B670VLOX	3,20	6	-	-	-
	80	7B680VLOXP	3,20	6	-	-	-
	90	7B690VLOXP	3,20	6	-	-	-
	100	7B6100VLOXP	3,20	6	-	-	-
	110	7B6110VLOXP	3,20	4	-	-	-
120	7B6120VLOXP	3,20	4	-	-	-	

Pedido mínimo: 10 Cajas brico 10 blisters por medida. Envasado en blister o caja larga.

Tornillo tirafondo DIN 571



Características

- Cabeza hexagonal.

Cincado		Blister			Caja profesional		
		Ø	Longitud	Código	€/blister		Código
5	40	7540571	3,20	10	4540571	6,30	50
	50	7550571	3,20	10	4550571	6,30	40
6	40	7640571	3,20	10	4640571	6,30	50
	50	7650571	3,20	10	4650571	6,30	40
	60	7660571	3,20	10	4660571	6,30	30
7	50	7750571	3,20	6	4750571	6,30	25
	60	7760571	3,20	6	4760571	6,30	20
	70	7770571	3,20	4	4770571	6,30	20
	80	7780571	3,20	4	4780571	6,30	20
8	50	7850571	3,20	4	4850571	6,30	20
	60	7860571	3,20	4	4860571	6,30	20
	70	7870571	3,20	4	4870571	6,30	15
	80	7880571	3,20	4	4880571	6,30	15
	90	7890571	3,20	4	-	-	-
10	100	78100571	3,20	4	-	-	-
	70	71070571	3,20	2	41070571	6,30	10
	80	71080571	3,20	2	41080571	6,30	10
	90	71090571	3,20	2	-	-	-
	100	710100571	3,20	2	-	-	-

Pedido mínimo: 10 cajas brico 10 blisters por medida. Envasado en blister o caja larga.

Tornillo ensamblaje ENE



Características

- Tornillo allen ensamblaje.

Cincado		Blister		
		Ø	Longitud	Código
5	50	7550ENE	3,20	12

Pedido Mínimo: 10 cajas brico 10 blisters por medida.

Tornillo broca alomada

DIN 7504N



Características

- Cabeza alomada.
- Philips (H).
- Punta broca.

Cincado		Blister			Caja profesional		
		Ø	Longitud	Código	€/blister		Código
3,5	9,5	735957504N	3,20	40	435957504N	6,30	200
	13	735137504N	3,20	35	435137504N	6,30	160
	16	735167504N	3,20	30	435167504N	6,30	150
4,2	13	742137504N	3,20	20	442137504N	6,30	120
	16	742167504N	3,20	20	442167504N	6,30	120
	19	742197504N	3,20	15	442197504N	6,30	110
	25	742257504N	3,20	10	442257504N	6,30	95
4,8	16	748167504N	3,20	25	448167504N	6,30	90
	19	748197504N	3,20	20	448197504N	6,30	85
	25	748257504N	3,20	20	448257504N	6,30	70
	32	748327504N	3,20	15	448327504N	6,30	60
	38	748387504N	3,20	15	448387504N	6,30	50
	45	748457504N	3,20	5	448457504N	6,30	40
	50	748507504N	3,20	5	448507504N	6,30	35
63	748637504N	3,20	5	448637504N	6,30	30	

Pedido mínimo: 10 cajas brico 10 blisters por medida.

Tornillo broca avellanada

DIN 7504P

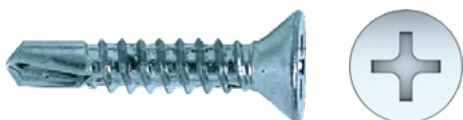

Características

- Cabeza avellanada.
- Philips (PH).
- Punta broca.

Cincado		Blister		
		Ø	Longitud	Código
3,5	13	735137504P	3,20	35
	16	735167504P	3,20	30

Pedido Mínimo: 10 cajas brico 10 blisters por medida.



Tornillo broca hexagonal

DIN 7504K



Características

- Punta broca N°3.
- Cabeza hexagonal.
- Acero cincado.

Cincado		Caja profesional		
				
Ø	Longitud	Código	€/Caja	
3,5	13	435137504K	6,30	130
	16	435167504K	6,30	120
4,2	13	442137504K	6,30	100
	16	442167504K	6,30	100
	19	442197504K	6,30	80
4,8	16	448167504K	6,30	75
	19	448197504K	6,30	70
	25	448257504K	6,30	55
6,3	25	463257504K	6,30	30
	32	463327504K	6,30	25

Pedido mínimo: 10 cajas brico 10 blisters por medida.



Tornillo avellanado

DIN 7982



Características

- Cabeza avellanada.
- Philips (PH).
- Punta forma C.

Cincado		Blister		
				
Ø	Longitud	Código	€/blister	
4,2	13	742137982	3,20	30
	16	742167982	3,20	25
	19	742197982	3,20	25
	25	742257982	3,20	20
	32	742327982	3,20	15
	38	742387982	3,20	15
4,8	19	748197982	3,20	20
	25	748257982	3,20	15

Pedido mínimo: 10 Cajas brico 10 blisters por medida.



Tornillo cartón yeso

chapa SSF



Características

- Cabeza Trompeta.
- Philips (PH).
- Punta Aguja.

Cincado		Blister		
				
Ø	Longitud	Código	€/blister	
3,5	25	7F3525SSF	3,20	40
	35	7F3535SSF	3,20	30

Pedido mínimo: 10 Cajas brico 10 blisters por medida.

Tornillo alomado

DIN 7981



Características

- Cabeza alomada.
- Philips (PH).
- Punta forma C.

Cincado Inox A2		Blister cincado			Blister Inox A2			Caja profesional		
Ø	Longitud	Código	€/blister		Código	€/blister		Código	€/Caja	
3,5	9,5	735957981	3,20	45	-	-	-	435957981	6,30	200
	13	735137981	3,20	40	7X35137981	3,20	25	435137981	6,30	160
	16	735167981	3,20	35	7X35167981	3,20	25	435167981	6,30	150
	19	735197981	3,20	30	7X35197981	3,20	20	-	-	-
3,9	9,5	739957981	3,20	40	-	-	-	-	-	170
	13	739137981	3,20	35	-	-	-	439137981	6,30	150
	16	739167981	3,20	30	-	-	-	-	-	-
	19	739197981	3,20	25	-	-	-	-	-	-
	25	739257981	3,20	20	-	-	-	-	-	-
4,2	9,5	742957981	3,20	30	-	-	-	-	-	140
	13	742137981	3,20	25	7X42137981	3,20	20	442137981	-	120
	16	742167981	3,20	25	7X42167981	3,20	20	442167981	-	120
	19	742197981	3,20	20	7X42197981	3,20	15	-	-	-
	22	742227981	3,20	15	-	-	-	-	-	-
	25	742257981	3,20	15	7X42257981	3,20	15	442257981	6,30	95
	32	742327981	3,20	15	7X42327981	3,20	10	442327981	6,30	60
	38	742387981	3,20	10	-	-	-	442387981	6,30	60
4,8	9,5	-	-	-	-	-	-	448957981	6,30	110
	13	748137981	3,20	20	-	-	-	*-	-	110
	16	748167981	3,20	20	7X48167981	3,20	10	448167981	6,30	90
	19	748197981	3,20	15	7X48197981	3,20	10	-	-	-
	22	748227981	3,20	15	-	-	-	-	-	-
	25	748257981	3,20	15	7X48257981	3,20	10	448257981	6,30	70
	32	748327981	3,20	10	-	-	-	448327981	6,30	60
	38	748387981	3,20	10	7X48387981	3,20	5	448387981	6,30	50
	45	748457981	3,20	10	-	-	-	-	-	-
	50	748507981	3,20	8	7X48507981	3,20	5	448507981	6,30	35
	60	748607981	3,20	6	7X48607981	3,20	5	-	-	-
5,5	16	755167981	3,20	15	-	-	-	-	-	-
	19	755197981	3,20	15	7X55197981	3,20	10	-	-	-
	25	755257981	3,20	10	7X55257981	3,20	8	-	-	-
	32	755327981	3,20	10	7X55327981	3,20	5	-	-	-
	38	755387981	3,20	5	7X55387981	3,20	5	455387981	6,30	40
	45	755457981	3,20	5	-	-	-	-	-	-
	50	755507981	3,20	5	-	-	-	-	-	-
	60	755607981	3,20	5	-	-	4	455607981	6,30	25

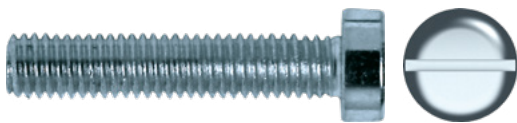

Pedido mínimo: 10 cajas brico 10 blisters por medida.

Tornillo cabeza cilíndrica DIN 84



Características

- Cabeza cilíndrica.
- Ranurado.
- Rosca métrica.

Cincado		Blister		
				
Ø	Longitud	Código	€/blister	
M3	10	731084	3,20	30
	16	731684	3,20	30
	20	732084	3,20	20
	25	732584	3,20	20
M4	10	741084	3,20	20
	16	741684	3,20	20
	20	742084	3,20	15
	25	742584	3,20	15
	30	743084	3,20	10
M5	10	751084	3,20	15
	16	751684	3,20	15
	20	752084	3,20	10
	25	752584	3,20	10
	30	753084	3,20	8
M6	40	754084	3,20	6
	10	761084	3,20	10
	16	761684	3,20	10
	20	762084	3,20	10
	25	762584	3,20	10
	30	763084	3,20	6
40	764084	3,20	6	
50	765084	3,20	6	



Pedido mínimo: 10 cajas brico 10 blisters por medida.

Arandela de acero DIN 125



Características

- Arandela plana de hierro.

Cincado		Blister		
				
Ø	Código	€/blister		
3	73125	3,20	250	
4	74125	3,20	210	
5	75125	3,20	200	
6	76125	3,20	75	
8	78125	3,20	40	

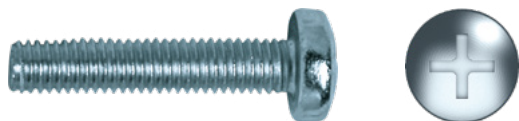

Pedido mínimo: 10 cajas brico 10 blisters por medida.

Tornillo alomado DIN 7985



Características

- Cabeza alomada.
- Philips.

Cincado		Blister			Caja profesional				
		Código	€/blister		Código	€/Caja			
Rosca	Longitud								
		M3	10	73107985	3,20	30	43107985	6,30	150
			16	-	-	-	43167985	6,30	140
	20	-	-	-	43207985	6,30	110		
M4	10	74107985	3,20	20	44107985	6,30	100		
	15	74157985	3,20	20	44157985	6,30	90		
	20	74207985	3,20	15	-	-	-		
	25	74257985	3,20	15	-	-	-		
	30	74307985	3,20	10	44307985	6,30	60		
M5	10	75107985	3,20	15	45107985	6,30	80		
	15	75157985	3,20	15	45157985	6,30	65		
	20	75207985	3,20	10	-	-	-		
	25	75257985	3,20	10	45257985	6,30	55		
	30	75307985	3,20	8	-	-	-		
	40	75407985	3,20	6	-	-	-		
M6	10	76107985	3,20	10	46107985	6,30	60		
	15	76157985	3,20	10	46157985	6,30*	50		
	20	76207985	3,20	10	46207985	6,30	50		
	25	76257985	3,20	10	46257985	6,30	40		
	30	76307985	3,20	6	46307985	6,30	30		
	40	76407985	3,20	6	-	-	-		



Pedido mínimo: 10 cajas brico 10 blisters por medida. * Hasta agotar existencias.

Arandela carroceros DIN 9021



Características

- Arandela plana de hierro.

Cincado		Blister			Caja profesional		
		Código	€/blister		Código	€/Caja	
∅							
4		749021	3,20	80	-	-	-
5		759021	3,20	40	-	-	-
6		769021	3,20	30	-	-	-
8		789021	3,20	10	-	-	-
10		-	-	-	4109021	6,30	10
12		-	-	-	4129021	6,30	10

Pedido mínimo: 10 cajas brico 10 blisters por medida. * Hasta agotar existencias.

Tuerca hexagonal DIN 934



Características

- Tuerca hexagonal.
- Calidad 8.

Cincado	Blisters			Caja profesional		
	Rosca	Código	€/blister		Código	€/Caja
M3	73934	3,20	145	–	–	–
M4	74934	3,20	95	44934	6,30	210
M5	75934	3,20	75	45934	6,30	180
M6	76934	3,20	45	46934	6,30	115
M8	78934	3,20	20	48934	6,30	55
M10	710934	3,20	10	410934	6,30	28
M12	712934	3,20	6	–	–	–

Pedido Mínimo: 10 Cajas Brico 10 Blisters por Medida.

Tuerca autoblocante inserto nylon DIN 985



Características

- Autoblocantes.

Cincado	Blisters		
	Rosca	Código	€/blister
M4	74985	3,20	30
M5	75985	3,20	30
M6	76985	3,20	20
M8	78985	3,20	10
M10	710985	3,20	8
M12	712985	3,20	4



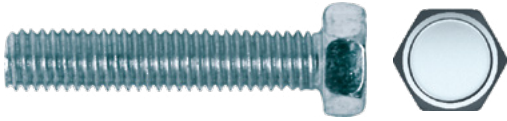

Pedido mínimo: 10 cajas brico 10 blisters por medida.

Tornillo hexagonal DIN 933



Características

- Cabeza hexagonal.
- Calidad 4.8.

Cincado		Blister			Caja profesional		
		Código	€/blister		Código	€/Caja	
Rosca	Longitud	Código	€/blister		Código	€/Caja	
M4	10	7410933	3,20	25	-	-	-
	15	7415933	3,20	20	-	-	-
	20	7420933	3,20	20	-	-	-
	30	7430933	3,20	15	-	-	-
M5	10	7510933	3,20	20	-	-	-
	15	7515933	3,20	15	-	-	-
	20	7520933	3,20	15	-	-	-
M6	10	7610933	3,20	15	4610933	6,30	65
	16	7616933	3,20	10	4616933	6,30	60
	20	7620933	3,20	10	4620933	6,30	60
	25	7625933	3,20	10	4625933	6,30	50
	30	7630933	3,20	10	4630933	6,30	45
	40	7640933	3,20	6	4640933	6,30	40
	50	7650933	3,20	6	-	-	-
M8	16	7816933	3,20	6	4816933	6,30	30
	20	7820933	3,20	6	4820933	6,30	30
	25	7825933	3,20	6	4825933	6,30	25
	30	7830933	3,20	4	4830933	6,30	25
	40	7840933	3,20	2	4840933	6,30	20
	50	7850933	3,20	2	4850933	6,30	15
	60	7860933	3,20	2	-	-	-
	70	7870933	3,20	2	4870933	6,30	10



Pedido mínimo: 10 cajas brico 10 blisters por medida. envasado en blister o caja larga.

Tornillo avellanado **DIN 963**



Características

- Cabeza cilíndrica.
- Ranurado.
- Rosca métrica.

Cincado		Blister		
				
Rosca	Longitud	Código	€/blister	
M3	10	7310963	3,20	35
	16	7316963	3,20	30
M4	10	7410963	3,20	20
	16	7416963	3,20	20
	20	7420963	3,20	20
	25	7425963	3,20	20
M5	10	7510963	3,20	20
	16	7516963	3,20	15
	20	7520963	3,20	15
	25	7525963	3,20	10



Pedido mínimo: 10 cajas brico 10 blisters por medida.

Hembrilla abierta **HA**



Características

- Cincado plata.



Alcayata acero		Blister		
				
Ø	Medida	Código	€/blister	
2,1	14 x 25	71425HA	3,20	22
2,4	16 x 30	21630HA	3,20	22
3,0	18 x 50	71850HA	3,20	14
3,5	19 x 60	71960HA	3,20	10
4,0	20 x 50	72050HA	3,20	10
	20 x 70	72070HA	3,20	8
4,5	21 x 80	72180HA	3,20	4

Alcayata roscada ALR



Características

- Cincado plata.



Alcayata roscada		Blister		
				
Ø	Medidas	Código	€/blister	
2,1	14 x 25	71425ALR	3,20	22
2,4	16 x 30	71630ALR	3,20	22
2,7	17 x 40	71740ALR	3,20	18
3,0	18 x 40	71840ALR	3,20	16
	18 x 50	71850ALR	3,20	14
3,5	19 x 50	71950ALR	3,20	12
	19 x 60	71960ALR	3,20	10
4,0	20 x 50	72050ALR	3,20	10
	20 x 60	72060ALR	3,20	8
4,5	21 x 70	72170ALR	3,20	6

Hembrilla cerrada HC



Características

- Cincado plata.

Hembrilla cerrada		Blister		
				
Ø	Medidas	Código	€/blister	
2,1	14 x 25	71425HC	3,20	22
2,4	16 x 30	71630HC	3,20	22
2,7	17 x 40	71740HC	3,20	18
3,5	19 x 60	71960HC	3,20	10
4,0	20 x 50	72050HC	3,20	10
	20 x 70	72070HC	3,20	8
4,5	21 x 80	72180HC	3,20	4
5,0	22 x 90	72290HC	3,20	4

Punto de venta

EXPOSITOR PICK&MIX

200 x 200 x 30 cm
147 referencias en el expositor.



Ferretería



Almacén Sanitario



Almacén Eléctrico



Pala para mejor selección de producto

Art: **PALAPM**

Envases marca CELO con código de barras con cierre zip.

Art: **9BCP [Pequeño]**
Art: **9BCM [Mediano]**



Tira de ganchos para blister o bolsas.

Art: **GANCOCTEL**

Cajón inferior para almacenaje de material.



Información detallada de cada referencia:

Medida

Código Artículo

Código de barras



Porta precios incluido

Descripción

Plano Técnico

Guía de colores:

- Tornillo de madera
- Tornillo rosca chapa
- Hembrillas
- Alcayatas
- Taco nylon
- Taco metálico
- Tornillo métrico
- Tapón adhesivo

Dispensador:

Envase pequeño : Art: **9BCP**
 Envase mediano: Art: **9BCM**
 Envase grande: Art: **9BCG**

EXPOSITOR PICK&MIX *a medida*

Espacio de autoservicio de tornillería y fijación.
 Estudio, diseño, implantación y mantenimiento.



Etiqueta

Información detallada etiqueta



Tiras informativas de referencias con código de color.

Adhesivos suelo antideslizantes con información detallada de las familias de productos.

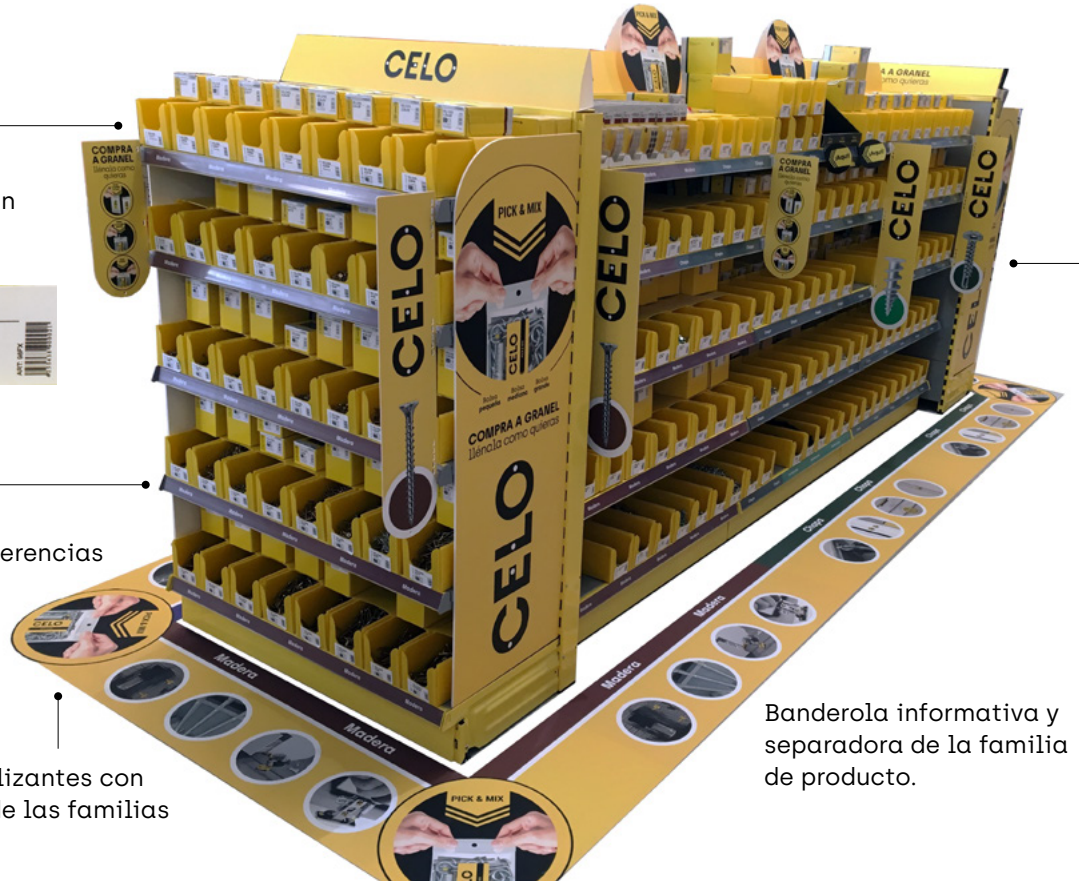

Banderola informativa y separadora de la familia de producto.

Dispensador de botes

Art: **DISPENSADORFX**

Bolsas autoservicio con sistema de sujeción.



Blister con guía de color.



Gancho metálicos reforzados
 Art N°: **9GLIN10**

Dispensador de botes
 Art: **EXPORESI24**

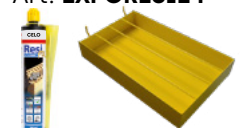

Cajas con ventana que permite al consumidor ver el producto.

Bandeja Inclinada para fijación nylon para 10 canales.

Art N°: **9BANIN1**



Separador metálicos para bandeja.

Art N°: **9150SLIN**



Small Things Matter

CELO Fijaciones SL
C/ Rosselló 7, 08211
Castellar del Vallés, España
T. +34 937 158 383